



MARKUP COPY

Agency No. 209.02

SPECIFICATIONS, TOLERANCES, AND OTHER TECHNICAL REQUIREMENTS FOR WEIGHING AND MEASURING DEVICES

NIST

United States Department of Commerce

Technology
Administration

National Institute of Standards and Technology

As adopted by the 97~~8~~th National Conference on Weights and Measures 201~~3~~⁴



NIST Handbook

44

201~~3~~⁴

Foreword

Handbook 44 was first published in 1949, having been preceded by similar handbooks of various designations and in several forms, beginning in 1918.

Handbook 44 is published in its entirety each year following the Annual Meeting of the National Conference on Weights and Measures (NCWM). The Committee on Specifications and Tolerances of the NCWM developed the ~~2013~~**2014** Edition with the assistance of the Weights and Measures Division (WMD) of the National Institute of Standards and Technology (NIST). This handbook includes amendments endorsed by the ~~97th~~**98th** National Conference on Weights and Measures during its Annual Meeting in ~~2012~~**2013**.

NIST has a statutory responsibility for “cooperation with the states in securing uniformity of weights and measures laws and methods of inspection.” In partial fulfillment of this responsibility, NIST is pleased to publish these recommendations of the NCWM.

This handbook conforms to the concept of primary use of SI (metric) measurements recommended in the Omnibus Trade and Competitiveness Act of 1988 by citing SI units before inch-pound units where both units appear together and placing separate sections containing requirements in SI units before corresponding sections containing requirements in inch-pound units. In some cases, however, trade practice is currently restricted to the use of inch-pound units; therefore, some requirements in this handbook will continue to specify only inch-pound units until the NCWM achieves a broad consensus on the permitted SI units.

In accord with NIST policy, the meter/liter spellings are used in this document. However, the metre/litre spellings are acceptable, and are preferred by the NCWM.

It should be noted that a space has been inserted instead of commas in all numerical values greater than 9999 in this document, following a growing practice, originating in tabular work, to use spaces to separate large numbers into groups of three digits. This avoids conflict with the practice in many countries to use the comma as a decimal marker.

You are invited to provide online feedback regarding this document
at: <https://www.surveymonkey.com/s/customer-satisfaction-pub>
or by e-mail to: owm@nist.gov.

**Committee on Specifications and Tolerances
of the 9798th Conference**

Kenneth Ramsburg, Maryland
Paul Moyer, Nebraska
Brett Gurney, Utah
Mahesh Albuquerque, Colorado

Edward Seidler, Town of Framingham, Massachusetts (July 2012 to February 2013)

Jane Zulkiewicz, Town of Barnstable, Massachusetts (February 2013 to present)

Luciano Burtini, Measurement Canada, Technical Advisor

Tina Butcher, NIST, Technical Advisor

Rick Harshman, NIST, Technical Advisor

Past Chairmen of the Committee

| <u>Conference</u> | <u>Chairman</u> | <u>Conference</u> | <u>Chairman</u> |
|-------------------|--------------------|-------------------|----------------------------------|
| 8-11 | L.A. Fischer, NBS | 70 | D.A. Guensler, CA |
| 12-28 | F.S. Holbrook, NBS | 71-72 | F. Gerk, NM |
| 29-38 | J.P. McBride, MA | 73 | K. Butcher, MD |
| 39-42 | R.E. Meek, IN | 74 | R. Andersen, NY |
| 43-44 | J.E. Brenton, CA | 75 | D. Watson, TX |
| 45-47 | C.L. Jackson, WI | 76 | J. Truex, OH |
| 48 | T.C. Harris, VA | 77-78 | C. Carroll, MA |
| 49-50 | R.E. Meek, IN | 79 | J. Jeffries, FL |
| 51-52 | G.L. Johnson, KY | 80 | R. Suiter, NE |
| 53 | H.D. Robinson, ME | 81 | G. West, NM |
| 54-55 | R. Rebuffo, NE | 82-83 | R. Murdock, NC |
| 56-57 | D.E. Konsoer, WI | 84 | D. Brown, IA |
| 58 | J.C. Mays, FL | 85 | M. Hopper, CA |
| 59 | T.F. Brink, VT | 86 | G. Shefcheck, OR |
| 60 | W.S. Watson, CA | 87 | M. Coyne, MA |
| 61 | K.J. Simila, OR | 88 | R. Wothlie, MD |
| 62 | W.E. Czaia, MN | 89 | C. VanBuren, MI |
| 63 | M.L. Kinlaw, NC | 90 | J. Kane, MT |
| 64 | J.A. Bird, NJ | 91 | C. Cooney, OR |
| 65 | D.A. Guensler, CA | 92 | M. Sikula, NY |
| 66 | G.A. Delano, MT | 93 | C. Fulmer, SC |
| 67 | F.C. Nagele, MI | 94 | T. R. Lucas, OH |
| 68 | L.H. DeGrange, MD | 95 | B. Saum, San Luis Obispo Co., CA |
| 69 | S.A. Colbrook, IL | 96-97 | S. Giguere, ME |

2013 Amendments

The following table lists the codes, paragraphs, and pages in which the 97th~~97~~⁹⁸~~th~~ National Conference on Weights and Measures made amendments. In the column headed “Action,” changes are noted as “added,” “amended,” “deleted,” or “renumbered.” Each code, section, or paragraph that has been changed will be noted as “Added ~~2012~~2013” or “Amended ~~2012~~2013.”

| SECTION | CODE | S&T ITEM NO. | PARAGRAPH | ACTION | PAGE |
|--------------------|--|-------------------------------|---|---|--|
| Introduction | L. Classifications for Agenda Items | BOD Item 120-4 | L. Classification for Agenda Items | Amended | 4 to 5 |
| | | | M. Developing Items | Deleted and renumbered remaining items | 5 to 7 |
| 2.20. | Scales | 320-31 | N.3.1. and N.3.1.1. S.6.4. | Amended Title | 2- 31 <u>25</u> |
| | | | Table T.1.1.S.6.4.M. | Added | 2- 36 <u>26</u> |
| | Belt conveyor Scale Systems | 321-1 | Table S.1-96.4. | Added | 2- 60 <u>26</u> |
| 2.21. | Belt-Conveyor Scale Systems | 321- 21 | UR.1.2.(h) | Deleted and renumbered remaining subparagraphs | 2- 67 <u>69</u> to 2- 71 <u>70</u> |
| 3.30. | Liquid Measuring Devices | 330-42 | S.1.6.4.1 Table T.2. | Amended | 3- 08 <u>21</u> |
| 3.31. | Vehicle-Tank Meters | 331-1 | S.1.6.5.4. | Amended | 3- 10 <u>40</u> |
| | | 331-2 | S.1.6.6 T.4. | Amended | 3- 11 <u>41</u> |
| | | | S.1.6.8 Table T.4. | Deleted | 3- 42 |
| 3.37. | Mass Flow Meters | 337-3 | UR.3 Table T.2. | Amended | 3- 22 <u>112</u> |
| 5.56.(a) | Water Grain Moisture Meters | 356-1 | Table S.3. and S.3.12.5. | Amended | 3- 97 <u>5-45</u> |
| 5.58. | Multiple Dimension Measuring Devices | 358-1 356-2 | N.1 UR.3.4.3. | Amended Deleted | 5- 79 <u>49</u> |
| 5.59.Appendix C | Electronic Livestock, Meat, and Poultry Evaluation Systems and/or Devices General Tables of Units of Measurement | 320-4359-1 | Status Units of Code Mass | Established uniform abbreviation for “short ton” and added footnote regarding effective dates. | 5- 85 <u>C-6</u> |
| | | | Avoirdupois Units of Mass | | Established uniform abbreviation for “short ton” |

| | | | | ton” and added footnote regarding effective dates. | |
|------------|----------------------|--------------------|---|--|--------|
| Appendix D | Glossary Definitions | 320- 61 | reference weight ear weigh module | Added | D-2229 |
| | | 321-2 | belt load | Added | D-7 |
| | | | belt revolution | Added | D-7 |
| | | | integrator | Added | D-15 |
| | | | loading point | Amended | D-16 |
| | | | master weight totalizer | Amended | D-17 |

20122013 Editorial Changes

| SECTION | CODE | PARAGRAPH | ACTION | PAGE |
|------------------|--|---|--|-------------------------|
| 1.10. | General | G-A.6. | Inserted the term “on or” following the word “enforceable” for consistency with nonretroactive dates throughout Handbook 44. | 1-3 |
| 2.2021. | Belt-Conveyor Scales | Table S.6N.2.3.b., Note 13 | Following the term “e.g.,” reinserted the word “postal,” which was inadvertently deleted in the previous edition. Replaced “(a)” and “(b)” in the latter section of the paragraph with “1.” and “2.” as in earlier editions of the handbook. | 2-2465 |
| Appendix C | General Tables of Units of Measurement | S.1.1.3. Units of Capacity or Volume – Liquid Volume Measurement | Delete the phrase “Volume Measuring Devices.” This phrase was added in 1991 (along with a number of other changes) as part of S&T Item 333-1 to recognize mass flow meters. NCWM agreed to remove references to mass flow meters in individual codes in 1994 (S&T Item 337-4A) when the Mass Flow Meters Code became a permanent code. Corrected milliliter equivalent of one gallon by deleting 3785.41 784 and replacing it with the correct value of 3785.411 784 milliliters. | 3-61 C-12 |

MARKUP COPY

Appendix A. Fundamental Considerations Associated with the Enforcement of Handbook 44 Codes

1. Uniformity of Requirements

1.1. National Conference Codes. – Weights and measures jurisdictions are urged to promulgate and adhere to the National Conference codes, to the end that uniform requirements may be in force throughout the country. This action is recommended even though a particular jurisdiction does not wholly agree with every detail of the National Conference codes. Uniformity of specifications and tolerances is an important factor in the manufacture of commercial equipment. Deviations from standard designs to meet the special demands of individual weights and measures jurisdictions are expensive, and any increase in costs of manufacture is, of course, passed on to the purchaser of equipment. On the other hand, if designs can be standardized by the manufacturer to conform to a single set of technical requirements, production costs can be kept down, to the ultimate advantage of the general public. Moreover, it seems entirely logical that equipment that is suitable for commercial use in the “specification” states should be equally suitable for such use in other states.

Another consideration supporting the recommendation for uniformity of requirements among weights and measures jurisdictions is the cumulative and regenerative effect of the widespread enforcement of a single standard of design and performance. The enforcement effort in each jurisdiction can then reinforce the enforcement effort in all other jurisdictions. More effective regulatory control can be realized with less individual effort under a system of uniform requirements than under a system in which even minor deviations from standard practice are introduced by independent state action.

Since the National Conference codes represent the majority opinion of a large and representative group of experienced regulatory officials, and since these codes are recognized by equipment manufacturers as their basic guide in the design and construction of commercial weighing and measuring equipment, the acceptance and promulgation of these codes by each state are strongly recommended.

1.2. Form of Promulgation. – A convenient and very effective form of promulgation already successfully used in a considerable number of states is promulgation by citation of National Institute of Standards and Technology Handbook 44. It is especially helpful when the citation is so made that, as amendments are adopted from time to time by the National Conference on Weights and Measures, these automatically go into effect in the state regulatory authority. For example, the following form of promulgation has been used successfully and is recommended for consideration:

The specifications, tolerances, and other technical requirements for weighing and measuring devices as recommended by the National Conference on Weights and Measures and published in the National Institute of Standards and Technology Handbook 44, “Specifications, Tolerances, and Other Technical Requirements for Weighing and Measuring Devices,” and supplements thereto or revisions thereof, shall apply to commercial weighing and measuring devices in the state.

In some states, it is preferred to base technical requirements upon specific action of the state legislature rather than upon an act of promulgation by a state officer. The advantages cited above may be obtained and may yet be surrounded by adequate safeguards to insure proper freedom of action by the state enforcing officer if the legislature adopts the National Conference requirements by language somewhat as follows:

The specifications, tolerances, and other technical requirements for weighing and measuring devices as recommended by the National Conference on Weights and Measures shall be the specifications, tolerances, and other technical requirements for weighing and measuring devices of the state except insofar as specifically modified, amended, or rejected by a regulation issued by the state (insert title of enforcing officer).

2. Tolerances for Commercial Equipment

2.1. Acceptance and Maintenance Tolerances. – The official tolerances prescribed by a weights and measures jurisdiction for commercial equipment are the limits of inaccuracy officially permissible within that jurisdiction. It is recognized that errorless value or performance of mechanical equipment is unattainable. Tolerances are established, therefore, to fix the range of inaccuracy within which equipment will be officially approved for commercial use. In the case of classes of equipment on which the magnitude of the errors of value or performance may be expected to change as a result of use, two sets of tolerances are established: acceptance tolerances and maintenance tolerances.

Acceptance tolerances are applied to new or newly reconditioned or adjusted equipment, and are smaller than (usually one-half of) the maintenance tolerances. Maintenance tolerances thus provide an additional range of inaccuracy within which equipment will be approved on subsequent tests, permitting a limited amount of deterioration before the equipment will be officially rejected for inaccuracy and before reconditioning or adjustment will be required. In effect, there is assured a reasonable period of use for equipment after it is placed in service before reconditioning will be officially required. The foregoing comments do not apply, of course, when only a single set of tolerance values is established, as is the case with equipment such as glass milk bottles and graduates, which maintain their original accuracy regardless of use, and measure-containers, which are used only once.

2.2. Theory of Tolerances. – Tolerance values are so fixed that the permissible errors are sufficiently small that there is no serious injury to either the buyer or the seller of commodities, yet not so small as to make manufacturing or maintenance costs of equipment disproportionately high. Obviously, the manufacturer must know what tolerances his equipment is required to meet, so that he can manufacture economically. His equipment must be good enough to satisfy commercial needs, but should not be subject to such stringent tolerance values as to make it unreasonably costly, complicated, or delicate.

2.3. Tolerances and Adjustments. – Tolerances are primarily accuracy criteria for use by the regulatory official. However, when equipment is being adjusted for accuracy, either initially or following repair or official rejection, the objective should be to adjust as closely as practicable to zero error. Equipment owners should not take advantage of tolerances by deliberately adjusting their equipment to have a value, or to give performance, at or close to the tolerance limit. Nor should the repair or service personnel bring equipment merely within tolerance range when it is possible to adjust closer to zero error.¹

3. Testing Apparatus

3.1. Adequacy.² – Tests can be made properly only if, among other things, adequate testing apparatus is available. Testing apparatus may be considered adequate only when it is properly designed for its intended use, when it is so constructed that it will retain its characteristics for a reasonable period under conditions of normal use, when it is available in denominations appropriate for a proper determination of the value or performance of the commercial equipment under test, and when it is accurately calibrated.

3.2. Tolerances for Standards. – Except for work of relatively high precision, it is recommended that the accuracy of standards used in testing commercial weighing and measuring equipment be established and maintained so that the use of corrections is not necessary. ~~When the~~When the standard is used without correction, its combined error and uncertainty must be less ~~than one~~than one-third of the applicable device tolerance.

¹ See General Code, Section 1.10.; User Requirement G-UR.4.3. Use of Adjustments.

² Recommendations regarding the specifications and tolerances for suitable field standards may be obtained from the Weights and Measures Division of the National Institute of Standards and Technology. Standards will meet the specifications of the National Institute of Standards and Technology Handbook 105-Series standards (or other suitable and designated standards). This section shall not preclude the use of additional field standards and/or equipment, as approved by the Director, for uniform evaluation of device performance.

Device testing is complicated to some degree when corrections to standards are applied. When using a correction for a standard, the uncertainty associated with the corrected value must be less than one-third of the applicable device tolerance. The reason for this requirement is to give the device being tested as nearly as practicable the full benefit of its own tolerance.

3.3. Accuracy of Standards. – Prior to the official use of testing apparatus, its accuracy should invariably be verified. Field standards should be calibrated as often as circumstances require. By their nature, metal volumetric field standards are more susceptible to damage in handling than are standards of some other types. A field standard should be calibrated whenever damage is known or suspected to have occurred or significant repairs have been made. In addition, field standards, particularly volumetric standards, should be calibrated with sufficient frequency to affirm their continued accuracy, so that the official may always be in an unassailable position with respect to the accuracy of his testing apparatus. Secondary field standards, such as special fabric testing tapes, should be verified much more frequently than such basic standards as steel tapes or volumetric provers to demonstrate their constancy of value or performance.

Accurate and dependable results cannot be obtained with faulty or inadequate field standards. If either the service person or official is poorly equipped, their results cannot be expected to check consistently. Disagreements can be avoided and the servicing of commercial equipment can be expedited and improved if service persons and officials give equal attention to the adequacy and maintenance of their testing apparatus.

4. Inspection of Commercial Equipment

4.1. Inspection Versus Testing. – A distinction may be made between the inspection and the testing of commercial equipment that should be useful in differentiating between the two principal groups of official requirements; i.e., specifications and performance requirements. Although the term inspection is frequently loosely used to include everything that the official has to do in connection with commercial equipment, it is useful to limit the scope of that term primarily to examinations made to determine compliance with design, maintenance, and user requirements. The term testing may then be limited to those operations carried out to determine the accuracy of value or performance of the equipment under examination by comparison with the actual physical standards of the official. These two terms will be used herein in the limited senses defined.

4.2. Necessity for Inspection. – It is not enough merely to determine that the errors of equipment do not exceed the appropriate tolerances. Specification and user requirements are as important as tolerance requirements and should be enforced. Inspection is particularly important, and should be carried out with unusual thoroughness whenever the official examines a type of equipment not previously encountered.

This is the way the official learns whether or not the design and construction of the device conform to the specification requirements. But even a device of a type with which the official is thoroughly familiar and that he has previously found to meet specification requirements should not be accepted entirely on faith. Some part may have become damaged, or some detail of design may have been changed by the manufacturer, or the owner or operator may have removed an essential element or made an objectionable addition. Such conditions may be learned only by inspection. Some degree of inspection is therefore an essential part of the official examination of every piece of weighing or measuring equipment.

4.3. Specification Requirements. – A thorough knowledge by the official of the specification requirements is a prerequisite to competent inspection of equipment. The inexperienced official should have his specifications before him when making an inspection, and should check the requirements one by one against the equipment itself. Otherwise some important requirement may be overlooked. As experience is gained, the official will become progressively less dependent on the handbook, until finally observance of faulty conditions becomes almost automatic and the time and effort required to do the inspecting are reduced to a minimum. The printed specifications, however, should always be available for reference to refresh the official's memory or to be displayed to support his decisions, and they are an essential item of his kit.

Specification requirements for a particular class of equipment are not all to be found in the separate code for that class. The requirements of the General Code apply, in general, to all classes of equipment, and these must always be

considered in combination with the requirements of the appropriate separate code to arrive at the total of the requirements applicable to a piece of commercial equipment.

4.4. General Considerations. – The simpler the commercial device, the fewer are the specification requirements affecting it, and the more easily and quickly can adequate inspection be made. As mechanical complexity increases, however, inspection becomes increasingly important and more time consuming, because the opportunities for the existence of faulty conditions are multiplied. It is on the relatively complex device, too, that the official must be on the alert to discover any modification that may have been made by an operator that might adversely affect the proper functioning of the device.

It is essential for the officials to familiarize themselves with the design and operating characteristics of the devices that he inspects and tests. Such knowledge can be obtained from the catalogs and advertising literature of device manufacturers, from trained service persons and plant engineers, from observation of the operations performed by service persons when reconditioning equipment in the field, and from a study of the devices themselves.

Inspection should include any auxiliary equipment and general conditions external to the device that may affect its performance characteristics. In order to prolong the life of the equipment and forestall rejection, inspection should also include observation of the general maintenance of the device and of the proper functioning of all required elements. The official should look for worn or weakened mechanical parts, leaks in volumetric equipment, or elements in need of cleaning.

4.5. Misuse of Equipment. – Inspection, coupled with judicious inquiry, will sometimes disclose that equipment is being improperly used, either through ignorance of the proper method of operation or because some other method is preferred by the operator. Equipment should be operated only in the manner that is obviously indicated by its construction or that is indicated by instructions on the equipment, and operation in any other manner should be prohibited.

4.6. Recommendations. – A comprehensive knowledge of each installation will enable the official to make constructive recommendations to the equipment owner regarding proper maintenance of his weighing and measuring devices and the suitability of his equipment for the purposes for which it is being used or for which it is proposed that it be used. Such recommendations are always in order and may be very helpful to an owner. The official will, of course, carefully avoid partiality toward or against equipment of specific makes, and will confine his recommendations to points upon which he is qualified, by knowledge and experience, to make suggestions of practical merit.

4.7. Accurate and Correct Equipment. – Finally, the weights and measures official is reminded that commercial equipment may be accurate without being correct. A piece of equipment is accurate when its performance or value (that is, its indications, its deliveries, its recorded representations, or its capacity or actual value, etc., as determined by tests made with suitable standards) conforms to the standard within the applicable tolerances and other performance requirements. Equipment that fails so to conform is inaccurate. A piece of equipment is correct when, in addition to being accurate, it meets all applicable specification requirements. Equipment that fails to meet any of the requirements for correct equipment is incorrect. Only equipment that is correct should be sealed and approved for commercial use.³

5. Correction of Commercial Equipment

5.1. Adjustable Elements. – Many types of weighing and measuring instruments are not susceptible to adjustment for accuracy by means of adjustable elements. Linear measures, liquid measures, graduates, measure-containers, milk and lubricating-oil bottles, farm milk tanks, dry measures, and some of the more simple types of scales are in this category. Other types (for example, taximeters and odometers and some metering devices) may be adjusted in the field, but only by changing certain parts such as gears in gear trains.

³ See Section 1.10. General Code and Appendix D. Definitions.

Some types, of which fabric-measuring devices and cordage-measuring devices are examples, are not intended to be adjusted in the field and require reconditioning in shop or factory if inaccurate. Liquid-measuring devices and most scales are equipped with adjustable elements, and some vehicle-tank compartments have adjustable indicators. Field adjustments may readily be made on such equipment. In the discussion that follows, the principles pointed out and the recommendations made apply to adjustments on any commercial equipment, by whatever means accomplished.

5.2. When Corrections Should Be Made. – One of the primary duties of a weights and measures official is to determine whether equipment is suitable for commercial use. If a device conforms to all legal requirements, the official “marks” or “seals” it to indicate approval. If it does not conform to all official requirements, the official is required to take action to ensure that the device is corrected within a reasonable period of time. Devices with performance errors that could result in serious economic injury to either party in a transaction should be prohibited from use immediately and not allowed to be returned to service until necessary corrections have been made. The official should consider the most appropriate action, based on all available information and economic factors.

Some officials contend that it is justifiable for the official to make minor corrections and adjustments if there is no service agency nearby or if the owner or operator depends on this single device and would be “out of business” if the use of the device were prohibited until repairs could be made. Before adjustments are made at the request of the owner or the owner’s representative, the official should be confident that the problem is not due to faulty installation or a defective part, and that the adjustment will correct the problem. The official should never undertake major repairs, or even minor corrections, if services of commercial agencies are readily available. The official should always be mindful of conflicts of interest before attempting to perform any services other than normal device examination and testing duties.

(Amended 1995)

5.3. Gauging. – In the majority of cases, when the weights and measures official tests commercial equipment, he is verifying the accuracy of a value or the accuracy of the performance as previously established either by himself or by someone else. There are times, however, when the test of the official is the initial test on the basis of which the calibration of the device is first determined or its performance first established. The most common example of such gauging is in connection with vehicle tanks the compartments of which are used as measures. Frequently the official makes the first determination on the capacities of the compartments of a vehicle tank, and his test results are used to determine the proper settings of the compartment indicators for the exact compartment capacities desired. Adjustments of the position of an indicator under these circumstances are clearly not the kind of adjustments discussed in the preceding paragraph.

6. Rejection of Commercial Equipment

6.1. Rejection and Condemnation. – The ~~uniform~~Uniform Weights and Measures Law contains a provision stating that the director shall reject and order to be corrected such physical weights and measures or devices found to be incorrect. Weights and measures and devices that have been rejected, may be seized if not corrected within a reasonable time or if used or disposed of in a manner not specifically authorized. The director shall remove from service and may seize weights and measures found to be incorrect that are not capable of being made correct.

These broad powers should be used by the official with discretion. The director should always keep in mind the property rights of an equipment owner, and cooperate in working out arrangements whereby an owner can realize at least something from equipment that has been rejected. In cases of doubt, the official should initially reject rather than condemn outright. Destruction and confiscation of equipment are harsh procedures. Power to seize and destroy is necessary for adequate control of extreme situations, but seizure and destruction should be resorted to only when clearly justified.

On the other hand, rejection is clearly inappropriate for many items of measuring equipment. This is true for most linear measures, many liquid and dry measures, ~~and~~ graduates, measure-containers, milk bottles, lubricating-oil bottles, and some scales. When such equipment is “incorrect,” it is either impractical or impossible to adjust or repair it, and the official has no alternative to outright condemnation. When only a few such items are involved, immediate destruction or confiscation is probably the best procedure. If a considerable number of items are involved (as, for example, a stock of measures in the hands of a dealer or a large shipment of bottles), return of these

to the manufacturer for credit or replacement should ordinarily be permitted provided that the official is assured that they will not get into commercial use. In rare instances, confiscation and destruction are justified as a method of control when less harsh methods have failed.

In the case of incorrect mechanisms such as fabric-measuring devices, taximeters, liquid-measuring devices, and most scales, repair of the equipment is usually possible, so rejection is the customary procedure. Seizure may occasionally be justified, but in the large majority of instances this should be unnecessary. Even in the case of worn-out equipment, some salvage is usually possible, and this should be permitted under proper controls.

(Amended 1995)

7. Tagging of Equipment

7.1. Rejected and Condemned. – It will ordinarily be practicable to tag or mark as rejected each item of equipment found to be incorrect and considered susceptible of proper reconditioning. However, it can be considered justifiable not to mark as rejected incorrect devices capable of meeting acceptable performance requirements if they are to be allowed to remain in service for a reasonable time until minor problems are corrected since marks of rejection may tend to be misleading about a device's ability to produce accurate measurements during the correction period. The tagging of equipment as condemned, or with a similar label to indicate that it is permanently out of service, is not recommended if there is any other way in which the equipment can definitely be put out of service. Equipment that cannot successfully be repaired should be dismantled, removed from the premises, or confiscated by the official rather than merely being tagged as "condemned."

(Amended 1995)

7.2. Nonsealed and Noncommercial. – Rejection is not appropriate if measuring equipment cannot be tested by the official at the time of his regular visit—for example, when there is no gasoline in the supply tank of a gasoline-dispensing device. Some officials affix to such equipment a nonsealed tag stating that the device has not been tested and sealed and that it must not be used commercially until it has been officially tested and approved. This is recommended whenever considerable time will elapse before the device can be tested.

Where the official finds in the same establishment, equipment that is in commercial use and also equipment suitable for commercial use that is not presently in service, but which may be put into service at some future time, he may treat the latter equipment in any of the following ways:

- (a) Test and approve the same as commercial equipment in use.
- (b) Refrain from testing it and remove it from the premises to preclude its use for commercial purposes.
- (c) Mark the equipment nonsealed.

Where the official finds commercial equipment and noncommercial equipment installed or used in close proximity, he may treat the noncommercial equipment in any of the following ways:

- (a) Test and approve the same as commercial equipment.
- (b) Physically separate the two groups of equipment so that misuse of the noncommercial equipment will be prevented.
- (c) Tag it to show that it has not been officially tested and is not to be used commercially.

8. Records of Equipment

8.1. The official will be well advised to keep careful records of equipment that is rejected, so that he may follow up to insure that the necessary repairs have been made. As soon as practicable following completion of repairs, the equipment should be retested. Complete records should also be kept of equipment that has been tagged as nonsealed

or noncommercial. Such records may be invaluable should it subsequently become necessary to take disciplinary steps because of improper use of such equipment.

9. Sealing of Equipment

9.1. Types of Seals and Their Locations. – Most weights and measures jurisdictions require that all equipment officially approved for commercial use (with certain exceptions to be pointed out later) be suitably marked or sealed to show approval. This is done primarily for the benefit of the public to show that such equipment has been officially examined and approved. The seal of approval should be as conspicuous as circumstances permit and should be of such a character and so applied that it will be reasonably permanent. Uniformity of position of the seal on similar types of equipment is also desirable as a further aid to the public.

The official will need more than one form of seal to meet the requirements of different kinds of equipment. Good quality, weather-resistant, water-adhesive, or pressure-sensitive seals or decalcomania seals are recommended for fabric-measuring devices, liquid-measuring devices, taximeters, and most scales, because of their permanence and good appearance. Steel stamps are most suitable for liquid and dry measures, for some types of linear measures, and for weights. An etched seal, applied with suitable etching ink, is excellent for steel tapes, and greatly preferable to a seal applied with a steel stamp. The only practicable seal for a graduate is one marked with a diamond or carbide pencil, or one etched with glass-marking ink. For a vehicle tank, the official may wish to devise a relatively large seal, perhaps of metal, with provision for stamping data relative to compartment capacities, the whole to be welded or otherwise permanently attached to the shell of the tank. In general, the lead-and-wire seal is not suitable as an approval seal.

9.2. Exceptions. – Commercial equipment such as measure-containers, milk bottles, and lubricating-oil bottles are not tested individually because of the time element involved. Because manufacturing processes for these items are closely controlled, an essentially uniform product is produced by each manufacturer. The official normally tests samples of these items prior to their sale within his jurisdiction and subsequently makes spot checks by testing samples selected at random from new stocks.

Another exception to the general rule for sealing approved equipment is found in certain very small weights whose size precludes satisfactory stamping with a steel die.

10. Rounding Off Numerical Values

10.1. Definition. – To round off or round a numerical value is to change the value of recorded digits to some other value considered more desirable for the purpose at hand by dropping or changing certain figures. For example, if a computed, observed, or accumulated value is 4738, this can be rounded off to the nearest thousand, hundred, or ten, as desired. Such rounded-off values would be, respectively, 5000, 4700, and 4740. Similarly, a value such as 47.382 can be rounded off to two decimal places, to one decimal place, or to the units place. The rounded-off figures in this example would be, respectively, 47.38, 47.4, and 47.

10.2. General Rules. – The general rules for rounding off may be stated briefly as follows:

- (a) When the figure next beyond the last figure or place to be retained is less than 5, the figure in the last place retained is to be kept unchanged. When rounding off 4738 to the nearest hundred, it is noted that the figure 3 (next beyond the last figure to be retained) is less than 5. Thus the rounded-off value would be 4700. Likewise, 47.382 rounded to two decimal places becomes 47.38.
- (b) When the figure next beyond the last figure or place to be retained is greater than 5, the figure in the last place retained is to be increased by 1. When rounding off 4738 to the nearest thousand, it is noted that the figure 7 (next beyond the last figure to be retained) is greater than 5. Thus the rounded-off value would be 5000. Likewise, 47.382 rounded to one decimal place becomes 47.4.

- (c) When the figure next beyond the last figure to be retained is 5 followed by any figures other than zero(s), treat as in (b) above; that is, the figure in the last place retained is to be increased by 1. When rounding off 4501 to the nearest thousand, 1 is added to the thousands figure and the result becomes 5000.
- (d) When the figure next beyond the last figure to be retained is 5 and there are no figures, or only zeros, beyond this 5, the figure in the last place to be retained is to be left unchanged if it is even (0, 2, 4, 6, or 8) and is to be increased by 1 if it is odd (1, 3, 5, 7, or 9). This is the odd and even rule, and may be stated as follows: “If odd, then add.” Thus, rounding off to the first decimal place, 47.25 would become 47.2 and 47.15 would become 47.2. Also, rounded to the nearest thousand, 4500 would become 4000 and 1500 would become 2000.

It is important to remember that, when there are two or more figures to the right of the place where the last significant figure of the final result is to be, the entire series of such figures must be rounded off in one step and not in two or more successive rounding steps. [Expressed differently, when two or more such figures are involved, these are not to be rounded off individually, but are to be rounded off as a group.] Thus, when rounding off 47.3499 to the first decimal place, the result becomes 47.3. In arriving at this result, the figures “499” are treated as a group. Since the 4 next beyond the last figure to be retained is less than 5, the “499” is dropped (see subparagraph (a) above). It would be incorrect to round off these figures successively to the left so that 47.3499 would become 47.350 and then 47.35 and then 47.4.

10.3. Rules for Reading of Indications. – An important aspect of rounding off values is the application of these rules to the reading of indications of an indicator-and-graduated-scale combination (where the majority of the indications may be expected to lie somewhere between two graduations) if it is desired to read or record values only to the nearest graduation. Consider a vertical graduated scale and an indicator. Obviously, if the indicator is between two graduations but is closer to one graduation than it is to the other adjacent graduation, the value of the closer graduation is the one to be read or recorded.

In the case where, as nearly as can be determined, the indicator is midway between two graduations, the odd-and-even rule is invoked, and the value to be read or recorded is that of the graduation whose value is even. For example, if the indicator lies exactly midway between two graduations having values of 471 and 472, respectively, the indication should be read or recorded as 472, this being an even value. If midway between graduations having values of 474 and 475, the even value 474 should be read or recorded. Similarly, if the two graduations involved had values of 470 and 475, the even value of 470 should be read or recorded.

A special case not covered by the foregoing paragraph is that of a graduated scale in which successive graduations are numbered by twos, all graduations thus having even values; for example, 470, 472, 474, etc. When, in this case, an indication lies midway between two graduations, the recommended procedure is to depart from the practice of reading or recording only to the value of the nearest graduation and to read or record the intermediate odd value. For example, an indication midway between 470 and 472 should be read as 471.

10.4. Rules for Common Fractions. – When applying the rounding-off rules to common fractions, the principles are to be applied to the numerators of the fractions that have, if necessary, been reduced to a common denominator. The principle of “5s” is changed to the one-half principle; that is, add if more than one-half, drop if less than one-half, and apply the odd-and even rule if exactly one-half.

For example, a series of values might be $1^{1/32}$, $1^{2/32}$, $1^{3/32}$, $1^{4/32}$, $1^{5/32}$, $1^{6/32}$, $1^{7/32}$, $1^{8/32}$, $1^{9/32}$. Assume that these values are to be rounded off to the nearest eighth ($^{4/32}$). Then,

$1^{1/32}$ becomes 1. ($^{1/32}$ is less than half of $^{4/32}$ and accordingly is dropped.)

$1^{2/32}$ becomes 1. ($^{2/32}$ is exactly one-half of $^{4/32}$; it is dropped because it is rounded (down) to the “even” eighth, which in this instance is $^0/8$.)

$1^{3/32}$ becomes $1^{4/32}$ or $1^{1/8}$. ($^{3/32}$ is more than half of $^{4/32}$, and accordingly is rounded “up” to $^{4/32}$ or $^{1/8}$.)

$1^{4/32}$ remains unchanged, being an exact eighth ($^{1/8}$).

$1^{5/32}$ becomes $1^{4/32}$ or $1^{1/8}$. ($^{5/32}$ is $^{1/32}$ more than an exact $^{1/8}$; $^{1/32}$ is less than half of $^{4/32}$ and accordingly is dropped.)

$1^{6/32}$ becomes $1^{2/8}$ or $1^{1/4}$. ($^{6/32}$ is $^{2/32}$ more than an exact $^{1/8}$; $^{2/32}$ is exactly one-half of $^{4/32}$, and the final fraction is rounded (up) to the “even” eighth, which in this instance is $^{2/8}$.)

$1^{7/32}$ becomes $1^{2/8}$ or $1^{1/4}$. ($^{7/32}$ is $^{3/32}$ more than an exact $^{1/8}$; $^{3/32}$ is more than one-half of $^{4/32}$ and accordingly the final fraction is rounded (up) to $^{2/8}$ or $^{1/4}$.)

$1^{8/32}$ remains unchanged, being an exact eighth ($1^{2/8}$ or $1^{1/4}$.)

$1^{9/32}$ becomes $1^{2/8}$ or $1^{1/4}$. ($^{9/32}$ is $^{1/32}$ more than an exact $^{1/8}$; $^{1/32}$ is less than half of $^{4/32}$ and accordingly is dropped.)

MARKUP COPY

THIS PAGE INTENTIONALLY LEFT BLANK

MARKUP COPY

Appendix B. Units and Systems of Measurement Their Origin, Development, and Present Status

1. Introduction

The National Institute of Standards and Technology (NIST) (formerly the National Bureau of Standards) was established by Act of Congress in 1901 to serve as a national scientific laboratory in the physical sciences, and to provide fundamental measurement standards for science and industry. In carrying out these related functions the Institute conducts research and development in many fields of physics, mathematics, chemistry, and engineering. At the time of its founding, the Institute had custody of two primary standards – the meter bar for length and the kilogram cylinder for mass. With the phenomenal growth of science and technology over the past century, the Institute has become a major research institution concerned not only with everyday weights and measures, but also with hundreds of other scientific and engineering standards that are necessary to the industrial progress of the nation. Nevertheless, the country still looks to NIST for information on the units of measurement, particularly their definitions and equivalents.

The subject of measurement systems and units can be treated from several different standpoints. Scientists and engineers are interested in the methods by which precision measurements are made. State weights and measures officials are concerned with laws and regulations that assure equity in the marketplace, protect public health and safety, and with methods for verifying commercial weighing and measuring devices. But a vastly larger group of people is interested in some general knowledge of the origin and development of measurement systems, of the present status of units and standards, and of miscellaneous facts that will be useful in everyday life. This material has been prepared to supply that information on measurement systems and units that experience has shown to be the common subject of inquiry.

2. Units and Systems of Measurement

The expression “weights and measures” is often used to refer to measurements of length, mass, and capacity or volume, thus excluding such quantities as electrical and time measurements and thermometry. This section on units and measurement systems presents some fundamental information to clarify the concepts of this subject and to eliminate erroneous and misleading use of terms.

It is essential that the distinction between the terms “units” and “standards” be established and kept in mind.

A unit is a special quantity in terms of which other quantities are expressed. In general, a unit is fixed by definition and is independent of such physical conditions as temperature. Examples: the meter, the liter, the gram, the yard, the pound, the gallon.

A standard is a physical realization or representation of a unit. In general, it is not entirely independent of physical conditions, and it is a representation of the unit only under specified conditions. For example, a meter standard has a length of one meter when at some definite temperature and supported in a certain manner. If supported in a different manner, it might have to be at a different temperature to have a length of one meter.

2.1. Origin and Early History of Units and Standards.

2.1.1. General Survey of Early History of Measurement Systems. – Weights and measures were among the earliest tools invented by man. Primitive societies needed rudimentary measures for many tasks: constructing dwellings of an appropriate size and shape, fashioning clothing, or bartering food or raw materials.

Man understandably turned first to parts of the body and the natural surroundings for measuring instruments. Early Babylonian and Egyptian records and the Bible indicate that length was first measured with the forearm, hand, or finger and that time was measured by the periods of the sun, moon, and other heavenly

bodies. When it was necessary to compare the capacities of containers such as gourds or clay or metal vessels, they were filled with plant seeds which were then counted to measure the volumes. When means for weighing were invented, seeds and stones served as standards. For instance, the “carat,” still used as a unit for gems, was derived from the carob seed.

Our present knowledge of early weights and measures comes from many sources. Archaeologists have recovered some rather early standards and preserved them in museums. The comparison of the dimensions of buildings with the descriptions of contemporary writers is another source of information. An interesting example of this is the comparison of the dimensions of the Greek Parthenon with the description given by Plutarch from which a fairly accurate idea of the size of the Attic foot is obtained. In some cases, we have only plausible theories and we must sometimes select the interpretation to be given to the evidence.

For example, does the fact that the length of the double-cubit of early Babylonia was equal (within two parts per thousand) to the length of the seconds pendulum at Babylon suggest a scientific knowledge of the pendulum at a very early date, or do we merely have a curious coincidence? By studying the evidence given by all available sources, and by correlating the relevant facts, we obtain some idea of the origin and development of the units. We find that they have changed more or less gradually with the passing of time in a complex manner because of a great variety of modifying influences. We find the units modified and grouped into measurement systems: the Babylonian system, the Egyptian system, the Philetarian system of the Ptolemaic age, the Olympic system of Greece, the Roman system, and the British system, to mention only a few.

2.1.2. Origin and Development of Some Common Customary Units. – The origin and development of units of measurement has been investigated in considerable detail and a number of books have been written on the subject. It is only possible to give here, somewhat sketchily, the story about a few units.

Units of length: The cubit was the first recorded unit used by ancient peoples to measure length. There were several cubits of different magnitudes that were used. The common cubit was the length of the forearm from the elbow to the tip of the middle finger. It was divided into the span of the hand (one-half cubit), the palm or width of the hand (one sixth), and the digit or width of a finger (one twenty-fourth). The Royal or Sacred Cubit, which was 7 palms or 28 digits long, was used in constructing buildings and monuments and in surveying. The inch, foot, and yard evolved from these units through a complicated transformation not yet fully understood. Some believe they evolved from cubic measures; others believe they were simple proportions or multiples of the cubit. In any case, the Greeks and Romans inherited the foot from the Egyptians. The Roman foot was divided into both 12 unciae (inches) and 16 digits. The Romans also introduced the mile of 1000 paces or double steps, the pace being equal to five Roman feet. The Roman mile of 5000 feet was introduced into England during the occupation. Queen Elizabeth, who reigned from 1558 to 1603, changed, by statute, the mile to 5280 feet or 8 furlongs, a furlong being 40 rods of 5½ yards each.

The introduction of the yard as a unit of length came later, but its origin is not definitely known. Some believe the origin was the double cubit, others believe that it originated from cubic measure. Whatever its origin, the early yard was divided by the binary method into 2, 4, 8, and 16 parts called the half-yard, span, finger, and nail. The association of the yard with the “gird” or circumference of a person’s waist or with the distance from the tip of the nose to the end of the thumb of Henry I are probably standardizing actions, since several yards were in use in Great Britain.

The point, which is a unit for measuring print type, is recent. It originated with Pierre Simon Fournier in 1737. It was modified and developed by the Didot brothers, Francois Ambroise and Pierre Francois, in 1755. The point was first used in the United States in 1878 by a Chicago type foundry (Marder, Luse, and Company). Since 1886, a point has been exactly 0.351 459 8 millimeters, or about $\frac{1}{72}$ inch.

Units of mass: The grain was the earliest unit of mass and is the smallest unit in the apothecary, avoirdupois, Tower, and Troy systems. The early unit was a grain of wheat or barleycorn used to weigh the precious metals silver and gold. Larger units preserved in stone standards were developed that were used as both units of mass and of monetary currency. The pound was derived from the mina used by ancient civilizations. A smaller unit was the shekel, and a larger unit was the talent. The magnitude of these units varied from place

to place. The Babylonians and Sumerians had a system in which there were 60 shekels in a mina and 60 minas in a talent. The Roman talent consisted of 100 libra (pound) which were smaller in magnitude than the mina. The Troy pound used in England and the United States for monetary purposes, like the Roman pound, was divided into 12 ounces, but the Roman uncia (ounce) was smaller. The carat is a unit for measuring gemstones that had its origin in the carob seed, which later was standardized at $\frac{1}{444}$ ounce and then 0.2 gram.

Goods of commerce were originally traded by number or volume. When weighing of goods began, units of mass based on a volume of grain or water were developed. For example, the talent in some places was approximately equal to the mass of one cubic foot of water. Was this a coincidence or by design? The diverse magnitudes of units having the same name, which still appear today in our dry and liquid measures, could have arisen from the various commodities traded. The larger avoirdupois pound for goods of commerce might have been based on volume of water, which has a higher bulk density than grain. For example, the Egyptian hon was a volume unit about 11 % larger than a cubic palm and corresponded to one mina of water. It was almost identical in volume to the present U.S. pint.

The stone, quarter, hundredweight, and ton were larger units of mass used in Great Britain. Today only the stone continues in customary use for measuring personal body weight. The present stone is 14 pounds, but an earlier unit appears to have been 16 pounds. The other units were multiples of 2, 8, and 160 times the stone, or 28, 112, and 2240 pounds, respectively. The hundredweight was approximately equal to two talents. In the United States the ton of 2240 pounds is called the “long ton.” The “short ton” is equal to 2000 pounds.

Units of time and angle: We can trace the division of the circle into 360 degrees and the day into hours, minutes, and seconds to the Babylonians who had a sexagesimal system of numbers. The 360 degrees may have been related to a year of 360 days.

2.2. The Metric System.

2.2.1. Definition, Origin, and Development. – Metric systems of units have evolved since the adoption of the first well-defined system in France in 1791. During this evolution the use of these systems spread throughout the world, first to the non-English-speaking countries, and more recently to the English-speaking countries. The first metric system was based on the centimeter, gram, and second (cgs) and these units were particularly convenient in science and technology. Later metric systems were based on the meter, kilogram, and second (mks) to improve the value of the units for practical applications. The present metric system is the International System of Units (SI). It is also based on the meter, kilogram and second as well as additional base units for temperature, electric current, luminous intensity, and amount of substance. The International System of Units is referred to as the modern metric system.

The adoption of the metric system in France was slow, but its desirability as an international system was recognized by geodesists and others. On May 20, 1875, an international treaty known as the International Metric Convention or the Treaty of the Meter was signed by seventeen countries including the United States. This treaty established the following organizations to conduct international activities relating to a uniform system for measurements:

- (1) The General Conference on Weights and Measures (French initials: CGPM), an intergovernmental conference of official delegates of member nations and the supreme authority for all actions;
- (2) The International Committee of Weights and Measures (French initials: CIPM), consisting of selected scientists and metrologists, which prepares and executes the decisions of the CGPM and is responsible for the supervision of the International Bureau of Weights and Measures;
- (3) The International Bureau of Weights and Measures (French initials: BIPM), a permanent laboratory and world center of scientific metrology, the activities of which include the establishment of the basic standards and scales of the principal physical quantities and maintenance of the international prototype standards.

The National Institute of Standards and Technology provides official United States representation in these organizations. The CGPM, the CIPM, and the BIPM have been major factors in the continuing refinement of the metric system on a scientific basis and in the evolution of the International System of Units.

Multiples and submultiples of metric units are related by powers of ten. This relationship is compatible with the decimal system of numbers and it contributes greatly to the convenience of metric units.

2.2.2. International System of Units. – At the end of World War II, a number of different systems of measurement still existed throughout the world. Some of these systems were variations of the metric system, and others were based on the customary inch-pound system of the English-speaking countries. It was recognized that additional steps were needed to promote a worldwide measurement system. As a result the 9th GCPM, in 1948, asked the ICPM to conduct an international study of the measurement needs of the scientific, technical, and educational communities. Based on the findings of this study, the 10th General Conference in 1954 decided that an international system should be derived from six base units to provide for the measurement of temperature and optical radiation in addition to mechanical and electromagnetic quantities. The six base units recommended were the meter, kilogram, second, ampere, Kelvin degree (later renamed the kelvin), and the candela.

In 1960, the 11th General Conference of Weights and Measures named the system based on the six base quantities the International System of Units, abbreviated SI from the French name: Le Système International d'Unités. The SI metric system is now either obligatory or permissible throughout the world.

2.2.3. Units and Standards of the Metric System. – In the early metric system there were two fundamental or base units, the meter and the kilogram, for length and mass. The other units of length and mass, and all units of area, volume, and compound units such as density were derived from these two fundamental units.

The meter was originally intended to be one ten-millionth part of a meridional quadrant of the earth. The Meter of the Archives, the platinum length standard which was the standard for most of the 19th century, at first was supposed to be exactly this fractional part of the quadrant. More refined measurements over the earth's surface showed that this supposition was not correct. In 1889, a new international metric standard of length, the International Prototype Meter, a graduated line standard of platinum-iridium, was selected from a group of bars because precise measurements found it to have the same length as the Meter of the Archives. The meter was then defined as the distance, under specified conditions, between the lines on the International Prototype Meter without reference to any measurements of the earth or to the Meter of the Archives, which it superseded. Advances in science and technology have made it possible to improve the definition of the meter and reduce the uncertainties associated with artifacts. From 1960 to 1983, the meter was defined as the length equal to 1 650 763.73 wavelengths in a vacuum of the radiation corresponding to the transition between the specified energy levels of the krypton 86 atom. Since 1983 the meter has been defined as the length of the path traveled by light in a vacuum during an interval of $1/299\,792\,458$ of a second.

The kilogram, originally defined as the mass of one cubic decimeter of water at the temperature of maximum density, was known as the Kilogram of the Archives. It was replaced after the International Metric Convention in 1875 by the International Prototype Kilogram which became the unit of mass without reference to the mass of a cubic decimeter of water or to the Kilogram of the Archives. Each country that subscribed to the International Metric Convention was assigned one or more copies of the international standards; these are known as National Prototype Meters and Kilograms.

The liter is a unit of capacity or volume. In 1964, the 12th GCPM redefined the liter as being one cubic decimeter. By its previous definition – the volume occupied, under standard conditions, by a quantity of pure water having a mass of one kilogram – the liter was larger than the cubic decimeter by 28 parts per 1 000 000. Except for determinations of high precision, this difference is so small as to be of no consequence.

The modern metric system (SI) includes two classes of units:

- (a) base units for length, mass, time, temperature, electric current, luminous intensity, and amount of substance; and
- (b) derived units for all other quantities (e.g., work, force, power) expressed in terms of the seven base units.

For details, see NIST Special Publication 330 (2001), The International System of Units (SI) and NIST Special Publication 811 (1995), Guide for the Use of the International System of Units.

2.2.4. International Bureau of Weights and Measures. – The ~~International~~**International** Bureau of Weights and Measures (BIPM) was established at Sèvres, a suburb of Paris, France, by the International Metric Convention of May 20, 1875. The BIPM maintains the International Prototype Kilogram, many secondary standards, and equipment for comparing standards and making precision measurements. The Bureau, funded by assessment of the signatory governments, is truly international. In recent years the scope of the work at the Bureau has been considerably broadened. It now carries on researches in the fields of electricity, photometry and radiometry, ionizing radiations, and time and frequency besides its work in mass, length, and thermometry.

2.2.5. Status of the Metric System in the United States. – The use of the metric system in this country was legalized by Act of Congress in 1866, but was not made obligatory then or since. Following the signing of the Convention of the Meter in 1875, the United States acquired national prototype standards for the meter and the kilogram. U.S. Prototype Kilogram No. 20 continues to be the primary standard for mass in the United States. It is recalibrated from time to time at the BIPM. The prototype meter has been replaced by modern stabilized lasers following the most recent definition of the meter.

From 1893 until 1959, the yard was defined as equal exactly to $^{3600}/_{3937}$ meter. In 1959, a small change was made in the definition of the yard to resolve discrepancies both in this country and abroad. Since 1959, we define the yard as equal exactly to 0.9144 meter; the new yard is shorter than the old yard by exactly two parts in a million. At the same time, it was decided that any data expressed in feet derived from geodetic surveys within the United States would continue to bear the relationship as defined in 1893 (one foot equals $^{1200}/_{3937}$ meter). We call this foot the U.S. Survey Foot, while the foot defined in 1959 is called the International Foot. Measurements expressed in U.S. statute miles, survey feet, rods, chains, links, or the squares thereof, and acres should be converted to the corresponding metric values by using pre-1959 conversion factors if more than five significant figure accuracy is required.

Since 1970, actions have been taken to encourage the use of metric units of measurement in the United States. A brief summary of actions by Congress is provided below as reported in the Federal Register Notice dated July 28, 1998.

Section 403 of Public Law 93-380, the Education Amendment of 1974, states that it is the policy of the United States to encourage educational agencies and institutions to prepare students to use the metric system of measurement as part of the regular education program. Under both this act and the Metric Conversion Act of 1975, the “metric system of measurement” is defined as the International System of Units as established in 1960 by the General Conference on Weights and Measures and interpreted or modified for the United States by the Secretary of Commerce (Section 4(4)- Public Law 94-168; Section 403(a)(3)- Public Law 93-380). The Secretary has delegated authority under these subsections to the Director of the National Institute of Standards and Technology.

Section 5164 of Public Law 100-418, the Omnibus Trade and Competitiveness Act of 1988, amends Public Law 94-168, The Metric Conversion Act of 1975. In particular, Section 3, The Metric Conversion Act is amended to read as follows:

“Sec. 3. It is therefore the declared policy of the United States–

- (1) to designate the metric system of measurement as the preferred system of weights and measures for United States trade and commerce;
- (2) to require that each federal agency, by a date certain and to the extent economically feasible by the end of the fiscal year 1992, use the metric system of measurement in its procurements, grants, and other business-related activities, except to the extent that such use is impractical or is likely to cause significant inefficiencies or loss of markets to U.S. firms, such as when foreign competitors are producing competing products in non-metric units;
- (3) to seek ways to increase understanding of the metric system of measurement through educational information and guidance and in government publications; and
- (4) to permit the continued use of traditional systems of weights and measures in nonbusiness activities.”

The Code of Federal Regulations makes the use of metric units mandatory for agencies of the federal government. (Federal Register, Vol. 56, No. 23, page 160, January 2, 1991.)

2.3. British and United States Systems of Measurement. – In the past, the customary system of weights and measures in the British Commonwealth countries and that in the United States were very similar; however, the SI metric system is now the official system of units in the United Kingdom, while the customary units are still predominantly used in the United States. Because references to the units of the old British customary system are still found, the following discussion describes the differences between the U.S. and British customary systems of units.

After 1959, the U.S. and the British inches were defined identically for scientific work and were identical in commercial usage. A similar situation existed for the U.S. and the British pounds, and many relationships, such as 12 inches = 1 foot, 3 feet = 1 yard, and 1760 yards = 1 international mile, were the same in both countries; but there were some very important differences.

In the first place, the U.S. customary bushel and the U.S. gallon, and their subdivisions differed from the corresponding British Imperial units. Also the British ton is 2240 pounds, whereas the ton generally used in the United States is the short ton of 2000 pounds. The American colonists adopted the English wine gallon of 231 cubic inches. The English of that period used this wine gallon and they also had another gallon, the ale gallon of 282 cubic inches. In 1824, the British abandoned these two gallons when they adopted the British Imperial gallon, which they defined as the volume of 10 pounds of water, at a temperature of 62 °F, which, by calculation, is equivalent to 277.42 cubic inches. At the same time, they redefined the bushel as 8 gallons.

In the customary British system, the units of dry measure are the same as those of liquid measure. In the United States these two are not the same; the gallon and its subdivisions are used in the measurement of liquids and the bushel, with its subdivisions, is used in the measurement of certain dry commodities. The U.S. gallon is divided into four liquid quarts and the U.S. bushel into 32 dry quarts. All the units of capacity or volume mentioned thus far are larger in the customary British system than in the U.S. system. But the British fluid ounce is smaller than the U.S. fluid ounce, because the British quart is divided into 40 fluid ounces whereas the U.S. quart is divided into 32 fluid ounces.

From this we see that in the customary British system an avoirdupois ounce of water at 62 °F has a volume of one fluid ounce, because 10 pounds is equivalent to 160 avoirdupois ounces, and 1 gallon is equivalent to 4 quarts, or 160 fluid ounces. This convenient relation does not exist in the U.S. system because a U.S. gallon of water at 62 °F weighs about 8½ pounds, or 133⅓ avoirdupois ounces, and the U.S. gallon is equivalent to 4 x 32, or 128 fluid ounces.

| | |
|---------------------------|---------------------------------|
| 1 U.S. fluid ounce | = 1.041 British fluid ounces |
| 1 British fluid ounce | = 0.961 U.S. fluid ounce |
| 1 U.S. gallon | = 0.833 British Imperial gallon |
| 1 British Imperial gallon | = 1.201 U.S. gallons |

Among other differences between the customary British and the United States measurement systems, we should note that they abolished the use of the troy pound in England January 6, 1879; they retained only the troy ounce and its subdivisions, whereas the troy pound is still legal in the United States, although it is not now greatly used. We can mention again the common use, for body weight, in England of the stone of 14 pounds, this being a unit now unused in the United States, although its influence was shown in the practice until World War II of selling flour by the barrel of 196 pounds (14 stone). In the apothecary system of liquid measure the British add a unit, the fluid scruple, equal to one third of a fluid drachm (spelled dram in the United States) between their minim and their fluid drachm. In the United States, the general practice now is to sell dry commodities, such as fruits and vegetables, by their mass.

2.4. Subdivision of Units. – In general, units are subdivided by one of three methods: (a) decimal, into tenths; (b) duodecimal, into twelfths; or (c) binary, into halves (twos). Usually the subdivision is continued by using the same method. Each method has its advantages for certain purposes, and it cannot properly be said that any one method is “best” unless the use to which the unit and its subdivisions are to be put is known.

For example, if we are concerned only with measurements of length to moderate precision, it is convenient to measure and to express these lengths in feet, inches, and binary fractions of an inch, thus 9 feet, $4\frac{3}{8}$ inches. However, if these lengths are to be subsequently used to calculate area or volume, that method of subdivision at once becomes extremely inconvenient. For that reason, civil engineers, who are concerned with areas of land, volumes of cuts, fills, excavations, etc., instead of dividing the foot into inches and binary subdivisions of the inch, divide it decimally; that is, into tenths, hundredths, and thousandths of a foot.

The method of subdivision of a unit is thus largely made based on convenience to the user. The fact that units have commonly been subdivided into certain subunits for centuries does not preclude their also having another mode of subdivision in some frequently used cases where convenience indicates the value of such other method. Thus, while we usually subdivide the gallon into quarts and pints, most gasoline-measuring pumps, of the price-computing type, are graduated to show tenths, hundredths, or thousandths of a gallon.

Although the mile has for centuries been divided into rods, yards, feet, and inches, the odometer part of an automobile speedometer shows tenths of a mile. Although we divide our dollar into 100 parts, we habitually use and speak of halves and quarters. An illustration of rather complex subdividing is found on the scales used by draftsmen. These scales are of two types: (a) architects, which are commonly graduated with scales in which $\frac{3}{32}$, $\frac{3}{16}$, $\frac{1}{8}$, $\frac{1}{4}$, $\frac{3}{8}$, $\frac{1}{2}$, $\frac{3}{4}$, 1, $1\frac{1}{2}$, and 3 inches, respectively, represent 1 foot full scale, and also having a scale graduated in the usual manner to $\frac{1}{16}$ inch; and (b) engineers, which are commonly subdivided to 10, 20, 30, 40, 50, and 60 parts to the inch.

The dictum of convenience applies not only to subdivisions of a unit but also to multiples of a unit. Land elevations above sea level are given in feet although the height may be several miles; the height of aircraft above sea level as given by an altimeter is likewise given in feet, no matter how high it may be.

On the other hand, machinists, toolmakers, gauge makers, scientists, and others who are engaged in precision measurements of relatively small distances, even though concerned with measurements of length only, find it convenient to use the inch, instead of the tenth of a foot, but to divide the inch decimally to tenths, hundredths, thousandths, etc., even down to millionths of an inch. Verniers, micrometers, and other precision measuring instruments are usually graduated in this manner. Machinist scales are commonly graduated decimally along one edge and are also graduated along another edge to binary fractions as small as $\frac{1}{64}$ inch. The scales with binary fractions are used only for relatively rough measurements.

It is seldom convenient or advisable to use binary subdivisions of the inch that are smaller than $\frac{1}{64}$. In fact, $\frac{1}{32}$ -, $\frac{1}{16}$ -, or $\frac{1}{8}$ -inch subdivisions are usually preferable for use on a scale to be read with the unaided eye.

2.5. Arithmetical Systems of Numbers. – The subdivision of units of measurement is closely associated with arithmetical systems of numbers. The systems of units used in this country for commercial and scientific work, having many origins as has already been shown, naturally show traces of the various number systems associated with their origins and developments. Thus, (a) the binary subdivision has come down to us from the Hindus, (b) the duodecimal system of fractions from the Romans, (c) the decimal system from the Chinese and Egyptians, some developments having been made by the Hindus, and (d) the sexagesimal system (division by 60) now illustrated in the subdivision of units of angle and of time, from the ancient Babylonians. The use of decimal numbers in measurements is becoming the standard practice.

3. Standards of Length, Mass, and Capacity or Volume

3.1. Standards of Length. – The meter, which is defined in terms of the speed of light in a vacuum, is the unit on which all length measurements are based.

The yard is defined⁴ as follows:

1 yard = 0.914 4 meter, and

1 inch = 25.4 millimeters exactly.

3.1.1. Calibration of Length Standards. – NIST calibrates standards of length including meter bars, yard bars, miscellaneous precision line standards, steel tapes, invar geodetic tapes, precision gauge blocks, micrometers, and limit gauges. It also measures the linear dimensions of miscellaneous apparatus such as penetration needles, cement sieves, and hemacytometer chambers. In general, NIST accepts for calibration only apparatus of such material, design, and construction as to ensure accuracy and permanence sufficient to justify calibration by the Institute. NIST performs calibrations in accordance with fee schedules, copies of which may be obtained from NIST.

NIST does not calibrate carpenters' rules, machinist scales, draftsman scales, and the like. Such apparatus, if they require calibration, should be submitted to state or local weights and measures officials.

3.2. Standards of Mass. – The primary standard of mass for this country is United States Prototype Kilogram 20, which is a platinum-iridium cylinder kept at NIST. We know the value of this mass standard in terms of the International Prototype Kilogram, a platinum-iridium standard which is kept at the International Bureau of Weights and Measures.

In Colonial Times the British standards were considered the primary standards of the United States. Later, the U.S. avoirdupois pound was defined in terms of the Troy Pound of the Mint, which is a brass standard kept at the United States Mint in Philadelphia. In 1911, the Troy Pound of the Mint was superseded, for coinage purposes, by the Troy Pound of the Institute.

The avoirdupois pound is defined in terms of the kilogram by the relation:

1 avoirdupois pound = 0.453 592 37 kilogram.⁵

These changes in definition have not made any appreciable change in the value of the pound.

The grain is $\frac{1}{7000}$ of the avoirdupois pound and is identical in the avoirdupois, troy, and apothecary systems. The troy ounce and the apothecary ounce differ from the avoirdupois ounce but are equal to each other, and equal to 480 grains. The avoirdupois ounce is equal to 437.5 grains.

⁴ See Federal Register for July 1, 1959. See also next-to-last paragraph of 2.2.5.

⁵ See Federal Register for July 1, 1959.

3.2.1. Mass and Weight. – The mass of a body is a measure of its inertial property or how much matter it contains. The weight of a body is a measure of the force exerted on it by gravity or the force needed to support it. Gravity on earth gives a body a downward acceleration of about 9.8 m/s^2 . (In common parlance, weight is often used as a synonym for mass in weights and measures.) The incorrect use of weight in place of mass should be phased out, and the term mass used when mass is meant.

Standards of mass are ordinarily calibrated by comparison to a reference standard of mass. If two objects are compared on a balance and give the same balance indication, they have the same “mass” (excluding the effect of air buoyancy). The forces of gravity on the two objects are balanced. Even though the value of the acceleration of gravity, g , is different from location to location, because the two objects of equal mass in the same location (where both masses are acted upon by the same g) will be affected in the same manner and by the same amount by any change in the value of g , the two objects will balance each other under any value of g .

However, on a spring balance the mass of a body is not balanced against the mass of another body. Instead, the gravitational force on the body is balanced by the restoring force of a spring. Therefore, if a very sensitive spring balance is used, the indicated mass of the body would be found to change if the spring balance and the body were moved from one locality to another locality with a different acceleration of gravity. But a spring balance is usually used in one locality and is adjusted or calibrated to indicate mass at that locality.

3.2.2. Effect of Air Buoyancy. – Another point that must be taken into account in the calibration and use of standards of mass is the buoyancy or lifting effect of the air. A body immersed in any fluid is buoyed up by a force equal to the force of gravity on the displaced fluid. Two bodies of equal mass, if placed one on each pan of an equal-arm balance, will balance each other in a vacuum. A comparison in a vacuum against a known mass standard gives “true mass.” If compared in air, however, they will not balance each other unless they are of equal volume. If of unequal volume, the larger body will displace the greater volume of air and will be buoyed up by a greater force than will the smaller body, and the larger body will appear to be of less mass than the smaller body.

The greater the difference in volume, and the greater the density of the air in which we make the comparison weighing, the greater will be the apparent difference in mass. For that reason, in assigning a precise numerical value of mass to a standard, it is necessary to base this value on definite values for the air density and the density of the mass standard of reference.

The apparent mass of an object is equal to the mass of just enough reference material of a specified density (at $20 \text{ }^\circ\text{C}$) that will produce a balance reading equal to that produced by the object if the measurements are done in air with a density of 1.2 mg/cm^3 at $20 \text{ }^\circ\text{C}$. The original basis for reporting apparent mass is apparent mass versus brass. The apparent mass versus a density of 8.0 g/cm^3 is the more recent definition, and is used extensively throughout the world. The use of apparent mass versus 8.0 g/cm^3 is encouraged over apparent mass versus brass. The difference in these apparent mass systems is insignificant in most commercial weighing applications.

A full discussion of this topic is given in NIST Monograph 133, Mass and Mass Values, by Paul E. Pontius [for sale by the National Technical Information Service, 5285 Port Royal Road, Springfield, VA 22161 (COM 7450309)].

3.2.3. Calibrations of Standards of Mass. – Standards of mass regularly used in ordinary trade should be tested by state or local weights and measures officials. NIST calibrates mass standards submitted, but it does not manufacture or sell them. Information regarding the mass calibration service of NIST and the regulations governing the submission of standards of mass to NIST for calibration are contained in NIST Special Publication 250, Calibration and Related Measurement Services of NIST, latest edition.

3.3. Standards of Capacity. – Units of capacity or volume, being derived units, are in this country defined in terms of linear units. Laboratory standards have been constructed and are maintained at NIST. These have validity only by calibration with reference either directly or indirectly to the linear standards. Similarly, NIST has made and

distributed standards of capacity to the several states. Other standards of capacity have been verified by calibration for a variety of uses in science, technology, and commerce.

3.3.1. Calibrations of Standards of Capacity. – NIST makes calibrations on capacity or volume standards that are in the customary units of trade; that is, the gallon, its multiples, and submultiples, or in metric units. Further, NIST calibrates precision-grade volumetric glassware which is normally in metric units. NIST makes calibrations in accordance with fee schedules, copies of which may be obtained from NIST.

3.4. Maintenance and Preservation of Fundamental Standard of Mass. – It is a statutory responsibility of NIST to maintain and preserve the national standard of mass at NIST and to realize all the other base units. The U.S. Prototype Kilogram maintained at NIST is fully protected by an alarm system. All measurements made with this standard are conducted in special air-conditioned laboratories to which the standard is taken a sufficiently long time before the observations to ensure that the standard will be in a state of equilibrium under standard conditions when the measurements or comparisons are made. Hence, it is not necessary to maintain the standard at standard conditions, but care is taken to prevent large changes of temperature. More important is the care to prevent any damage to the standard because of careless handling.

4. Specialized Use of the Terms “Ton” and “Tonnage”

As weighing and measuring are important factors in our everyday lives, it is quite natural that questions arise about the use of various units and terms and about the magnitude of quantities involved. For example, the words “ton” and “tonnage” are used in widely different senses, and a great deal of confusion has arisen regarding the application of these terms.

The ton is used as a unit of measure in two distinct senses: (1) as a unit of mass, and (2) as a unit of capacity or volume.

In the first sense, the term has the following meanings:

- (a) The short, or net ton of 2000 pounds.
- (b) The long, gross, or shipper’s ton of 2240 pounds.
- (c) The metric ton of 1000 kilograms, or 2204.6 pounds.

In the second sense (capacity), it is usually restricted to uses relating to ships and has the following meaning:

- (a) The register ton of 100 cubic feet.
- (b) The measurement ton of 40 cubic feet.
- (c) The English water ton of 224 British Imperial gallons.

In the United States and Canada the ton (mass) most commonly used is the short ton. In Great Britain, it is the long ton, and in countries using the metric system, it is the metric ton. The register ton and the measurement ton are capacity or volume units used in expressing the tonnage of ships. The English water ton is used, chiefly in Great Britain, in statistics dealing with petroleum products.

There have been many other uses of the term ton such as the timber ton of 40 cubic feet and the wheat ton of 20 bushels, but their uses have been local and the meanings have not been consistent from one place to another. Properly, the word “tonnage” is used as a noun only in respect to the capacity or volume and dimensions of ships, and to the amount of the ship’s cargo. There are two distinct kinds of tonnage; namely, vessel tonnage and cargo tonnage and each of these is used in various meanings. The several kinds of vessel tonnage are as follows:

Gross tonnage, or gross register tonnage, is the total cubical capacity or volume of a ship expressed in register tons of 100 cubic feet, or 2.83 cubic meters, less such space as hatchways, bakeries, galleys, etc., as are exempted from measurement by different governments. There is some lack of uniformity in the gross tonnages as given by different nations due to lack of agreement on the spaces that are to be exempted. Official merchant marine statistics of most countries are published in terms of the gross register tonnage. Press references to ship tonnage are usually to the gross tonnage.

The net tonnage, or net register tonnage, is the gross tonnage less the different spaces specified by maritime nations in their measurement rules and laws. The spaces deducted are those totally unavailable for carrying cargo, such as the engine room, coal bunkers, crew quarters, chart and instrument room, etc. The net tonnage is used in computing how much cargo that can be loaded on a ship. It is used as the basis for wharfage and other similar charges.

The register under-deck tonnage is the cubical capacity of a ship under her tonnage deck expressed in register tons. In a vessel having more than one deck, the tonnage deck is the second from the keel.

There are several variations of displacement tonnage.

The dead weight tonnage is the difference between the “loaded” and “light” displacement tonnages of a vessel. It is expressed in terms of the long ton of 2240 pounds, or the metric ton of 2204.6 pounds, and is the weight of fuel, passengers, and cargo that a vessel can carry when loaded to its maximum draft.

The second variety of tonnage, cargo tonnage, refers to the weight of the particular items making up the cargo. In overseas traffic it is usually expressed in long tons of 2240 pounds or metric tons of 2204.6 pounds. The short ton is only occasionally used. Therefore, the cargo tonnage is very distinct from vessel tonnage.

THIS PAGE INTENTIONALLY LEFT BLANK

MARKUP COPY

Appendix C. General Tables of Units of Measurement

These tables have been prepared for the benefit of those requiring tables of units for occasional ready reference. In Section 4 of this Appendix, the tables are carried out to a large number of decimal places and exact values are indicated by underlining. In most of the other tables, only a limited number of decimal places are given, therefore making the tables better adapted to the average user.

1. Tables of Metric Units of Measurement

In the metric system of measurement, designations of multiples and subdivisions of any unit may be arrived at by combining with the name of the unit the prefixes deka, hecto, and kilo meaning, respectively, 10, 100, and 1000, and deci, centi, and milli, meaning, respectively, one-tenth, one-hundredth, and one-thousandth. In some of the following metric tables, some such multiples and subdivisions have not been included for the reason that these have little, if any currency in actual usage.

In certain cases, particularly in scientific usage, it becomes convenient to provide for multiples larger than 1000 and for subdivisions smaller than one-thousandth. Accordingly, the following prefixes have been introduced and these are now generally recognized:

| | | | |
|------------|-------------------|------------------|--------------------|
| yotta, (Y) | meaning 10^{24} | deci, (d) | meaning 10^{-1} |
| zetta, (Z) | meaning 10^{21} | centi, (c) | meaning 10^{-2} |
| exa, (E) | meaning 10^{18} | milli, (m) | meaning 10^{-3} |
| peta, (P) | meaning 10^{15} | micro, (μ) | meaning 10^{-6} |
| tera, (T) | meaning 10^{12} | nano, (n) | meaning 10^{-9} |
| giga, (G) | meaning 10^9 | pico, (p) | meaning 10^{-12} |
| mega, (M) | meaning 10^6 | femto, (f) | meaning 10^{-15} |
| kilo, (k) | meaning 10^3 | atto, (a) | meaning 10^{-18} |
| hecto, (h) | meaning 10^2 | zepto, (z) | meaning 10^{-21} |
| deka, (da) | meaning 10^1 | yocto, (y) | meaning 10^{-24} |

Thus a kilometer is 1000 meters and a millimeter is 0.001 meter.

Units of Length

| | |
|---------------------|--------------------------------------|
| 10 millimeters (mm) | = 1 centimeter (cm) |
| 10 centimeters | = 1 decimeter (dm) = 100 millimeters |
| 10 decimeters | = 1 meter (m) = 1000 millimeters |
| 10 meters | = 1 dekameter (dam) |
| 10 dekameters | = 1 hectometer (hm) = 100 meters |
| 10 hectometers | = 1 kilometer (km) = 1000 meters |

Units of Area

| | |
|--|--|
| 100 square millimeters (mm^2) | = 1 square centimeter (cm^2) |
| 100 square centimeters | = 1 square decimeter (dm^2) |
| 100 square decimeters | = 1 square meter (m^2) |
| 100 square meters | = 1 square dekameter (dam^2) = 1 are |
| 100 square dekameters | = 1 square hectometer (hm^2) = 1 hectare (ha) |
| 100 square hectometers | = 1 square kilometer (km^2) |

Units of Liquid Volume

| | |
|---------------------|---|
| 10 milliliters (mL) | = 1 centiliter (cL) |
| 10 centiliters | = 1 deciliter (dL) = 100 milliliters |
| 10 deciliters | = 1 liter ⁶ = 1000 milliliters |
| 10 liters | = 1 dekaliter (daL) |
| 10 dekaliters | = 1 hectoliter (hL) = 100 liters |
| 10 hectoliters | = 1 kiloliter (kL) = 1000 liters |

Units of Volume

| | |
|---|---|
| 1000 cubic millimeters (mm ³) | = 1 cubic centimeter (cm ³) |
| 1000 cubic centimeters | = 1 cubic decimeter (dm ³) |
| | = 1 000 000 cubic millimeters |
| 1000 cubic decimeters | = 1 cubic meter (m ³) |
| | = 1 000 000 cubic centimeters |
| | = 1 000 000 000 cubic millimeters |

Units of Mass

| | |
|--------------------|--------------------------------------|
| 10 milligrams (mg) | = 1 centigram (cg) |
| 10 centigrams | = 1 decigram (dg) = 100 milligrams |
| 10 decigrams | = 1 gram (g) = 1000 milligrams |
| 10 grams | = 1 dekagram (dag) |
| 10 dekagrams | = 1 hectogram (hg) = 100 grams |
| 10 hectograms | = 1 kilogram (kg) = 1000 grams |
| 1000 kilograms | = 1 megagram (Mg) or 1 metric ton(t) |

2. Tables of U.S. Units of Measurement⁷

In these tables where foot or mile is underlined, it is survey foot or U.S. statute mile rather than international foot or mile that is meant.

Units of Length

| | |
|-----------------|---|
| 12 inches (in) | = 1 foot (ft) |
| 3 feet | = 1 yard (yd) |
| 16½ <u>feet</u> | = 1 rod (rd), pole, or perch |
| 40 rods | = 1 furlong (fur) = 660 <u>feet</u> |
| 8 furlongs | = 1 U.S. statute mile (mi) = 5280 <u>feet</u> |
| 1852 meters (m) | = 6076.115 49 feet (approximately) |
| | = 1 international nautical mile |

⁶ By action of the 12th General Conference on Weights and Measures (1964), the liter is a special name for the cubic decimeter.

⁷ This section lists units of measurement that have traditionally been used in the United States. In keeping with the Omnibus Trade and Competitiveness Act of 1988, the ultimate objective is to make the International System of Units the primary measurement system used in the United States.

Units of Area⁸

| | |
|--------------------------------------|---|
| 144 square inches (in ²) | = 1 square foot (ft ²) |
| 9 square feet | = 1 square yard (yd ²) |
| | = 1296 square inches |
| 272¼ square <u>feet</u> | = 1 square rod (rd ²) |
| 160 square rods | = 1 acre = 43 560 square <u>feet</u> |
| 640 acres | = 1 square <u>mile</u> (mi ²) |
| 1 <u>mile</u> square | = 1 section of land |
| 6 <u>miles</u> square | = 1 township |
| | = 36 sections = 36 square <u>miles</u> |

Units of Volume³

| | |
|--------------------------------------|-----------------------------------|
| 1728 cubic inches (in ³) | = 1 cubic foot (ft ³) |
| 27 cubic feet | = 1 cubic yard (yd ³) |

Gunter's or Surveyors Chain Units of Measurement

| | |
|-----------------------|-------------------------------|
| 0.66 <u>foot</u> (ft) | = 1 link (li) |
| 100 links | = 1 chain (ch) |
| | = 4 rods = 66 <u>feet</u> |
| 80 chains | = 1 U.S. statute mile (mi) |
| | = 320 rods = 5280 <u>feet</u> |

Units of Liquid Volume⁹

| | |
|--------------|--|
| 4 gills (gi) | = 1 pint (pt) = 28.875 cubic inches (in ³) |
| 2 pints | = 1 quart (qt) = 57.75 cubic inches |
| 4 quarts | = 1 gallon (gal) = 231 cubic inches |
| | = 8 pints = 32 gills |

Apothecaries Units of Liquid Volume

| | |
|-----------------|---|
| 60 minims | = 1 fluid dram (fl dr or <i>f</i> ʒ) |
| | = 0.225 6 cubic inch (in ³) |
| 8 fluid drams | = 1 fluid ounce (fl oz or <i>f</i> ʒ) |
| | = 1.804 7 cubic inches |
| 16 fluid ounces | = 1 pint (pt) |
| | = 28.875 cubic inches |
| | = 128 fluid drams |
| 2 pints | = 1 quart (qt) = 57.75 cubic inches |
| | = 32 fluid ounces = 256 fluid drams |
| 4 quarts | = 1 gallon (gal) = 231 cubic inches |
| | = 128 fluid ounces = 1024 fluid drams |

⁸ Squares and cubes of customary but not of metric units are sometimes expressed by the use of abbreviations rather than symbols. For example, sq ft means square foot, and cu ft means cubic foot.

⁹ When necessary to distinguish the liquid pint or quart from the dry pint or quart, the word “liquid” or the abbreviation “liq” should be used in combination with the name or abbreviation of the liquid unit.

Units of Dry Volume¹⁰

| | |
|--------------|---|
| 2 pints (pt) | = 1 quart (qt) = 67.200 6 cubic inches (in ³) |
| 8 quarts | = 1 peck (pk) = 537.605 cubic inches |
| | = 16 pints |
| 4 pecks | = 1 bushel (bu) = 2150.42 cubic inches |
| | = 32 quarts |

Avoirdupois Units of Mass¹¹

[The “grain” is the same in avoirdupois, troy, and apothecaries units of mass.]

| | |
|---------------------------------|---------------------------------------|
| 1 µlb | = 0.000 001 pound (lb) |
| 27 ^{11/32} grains (gr) | = 1 dram (dr) |
| 16 drams | = 1 ounce (oz) |
| | = 437½ grains |
| 16 ounces | = 1 pound (lb) |
| | = 256 drams |
| | = 7000 grains |
| 100 pounds | = 1 hundredweight (cwt) ¹² |
| 20 hundredweights | = 1 ton (t)tn ¹³ |
| | = 2000 pounds ⁷ |
| | = 2000 pounds ⁷ |

In “gross” or “long” measure, the following values are recognized:

| | |
|---------------------------------|--|
| | = 1 gross or long hundredweight (cwt) ⁷ |
| 112 pounds (lb) | ⁷ |
| 20 gross or long hundredweights | = 1 gross or long ton |
| | = 2240 pounds ⁷ |

¹⁰ When necessary to distinguish dry pint or quart from the liquid pint or quart, the word “dry” should be used in combination with the name or abbreviation of the dry unit.

⁶ When necessary to distinguish the avoirdupois dram from the apothecaries dram, or to distinguish the avoirdupois dram or ounce from the fluid dram or ounce, or to distinguish the avoirdupois ounce or pound from the troy or apothecaries ounce or pound, the word “avoirdupois” or the abbreviation “avdp” should be used in combination with the name or abbreviation of the avoirdupois unit.

⁷ When the terms “hundredweight” and “ton” are used unmodified, they are commonly understood to mean the 100-pound hundredweight and the 2000-pound ton, respectively; these units may be designated “net” or “short” when necessary to distinguish them from the corresponding units in gross or long measure.

¹³ As of January 1, 2014, “tn” is the required abbreviation for “short ton.” Devices manufactured between January 1, 2008, and December 31, 2013, may use an abbreviation other than “tn” to specify “short ton.”

Troy Units of Mass

[The “grain” is the same in avoirdupois, troy, and apothecaries units of mass.]

| | |
|-----------------|------------------------------------|
| 24 grains (gr) | = 1 pennyweight (dwt) |
| 20 pennyweights | = 1 ounce troy (oz t) = 480 grains |
| 12 ounces troy | = 1 pound troy (lb t) |
| | = 240 pennyweights = 5760 grains |

Apothecaries Units of Mass

[The “grain” is the same in avoirdupois, troy, and apothecaries units of mass.]

| | |
|------------------------|---|
| 20 grains (gr) | = 1 scruple (s ap or \mathfrak{S}) |
| 3 scruples | = 1 dram apothecaries (dr ap ap or \mathfrak{D}) |
| | = 60 grains |
| 8 drams apothecaries | = 1 ounce apothecaries (oz ap or \mathfrak{Z}) |
| | = 24 scruples = 480 grains |
| 12 ounces apothecaries | = 1 pound apothecaries (lb ap) |
| | = 96 drams apothecaries |
| | = 288 scruples = 5760 grains |

3. Notes on British Units of Measurement

In Great Britain, the yard, the avoirdupois pound, the troy pound, and the apothecaries pound are identical with the units of the same names used in the United States. The tables of British linear measure, troy mass, and apothecaries mass are the same as the corresponding United States tables, except for the British spelling “drachm” in the table of apothecaries mass. The table of British avoirdupois mass is the same as the United States table up to 1 pound; above that point the table reads:

| | |
|------------------|--------------------------------|
| 14 pounds | = 1 stone |
| 2 stones | = 1 quarter = 28 pounds |
| 4 quarters | = 1 hundredweight = 112 pounds |
| 20 hundredweight | = 1 ton = 2240 pounds |

The present British gallon and bushel – known as the “Imperial gallon” and “Imperial bushel” – are, respectively, about 20 % and 3 % larger than the United States gallon and bushel. The Imperial gallon is defined as the volume of 10 avoirdupois pounds of water under specified conditions, and the Imperial bushel is defined as 8 Imperial gallons. Also, the subdivision of the Imperial gallon as presented in the table of British apothecaries fluid measure differs in two important respects from the corresponding United States subdivision, in that the Imperial gallon is divided into 160 fluid ounces (whereas the United States gallon is divided into 128 fluid ounces), and a “fluid scruple” is included. The full table of British measures of capacity (which are used alike for liquid and for dry commodities) is as follows:

| | |
|---------------------|-------------|
| 4 gills | = 1 pint |
| 2 pints | = 1 quart |
| 4 quarts | = 1 gallon |
| 2 gallons | = 1 peck |
| 8 gallons (4 pecks) | = 1 bushel |
| 8 bushels | = 1 quarter |

The full table of British apothecaries measure is as follows:

| | |
|------------------|-------------------------------|
| 20 minims | = 1 fluid scruple |
| 3 fluid scruples | = 1 fluid drachm |
| | = 60 minims |
| 8 fluid drachms | = 1 fluid ounce |
| 20 fluid ounces | = 1 pint |
| 8 pints | = 1 gallon (160 fluid ounces) |

4. Tables of Units of Measurement

(all underlined figures are exact)

Units of Length - International Measure¹⁴

| Units | Inches | Feet | Yards | Miles | Centimeters | Meters |
|----------------|---------------|--------------|--------------|-------------------|------------------|-----------------|
| 1 inch = | <u>1</u> | 0.083 333 33 | 0.027 777 78 | 0.000 015 782 83 | <u>2.54</u> | <u>0.025 4</u> |
| 1 foot = | <u>12</u> | <u>1</u> | 0.333 333 3 | 0.000 189 393 9 | <u>30.48</u> | <u>0.304 8</u> |
| 1 yard = | <u>36</u> | <u>3</u> | <u>1</u> | 0.000 568 181 8 | <u>91.44</u> | <u>0.914 4</u> |
| 1 mile = | <u>63 360</u> | <u>5 280</u> | <u>1 760</u> | <u>1</u> | <u>160 934.4</u> | <u>1609.344</u> |
| 1 centimeter = | 0.393 700 8 | 0.032 808 40 | 0.010 936 13 | 0.000 006 213 712 | <u>1</u> | <u>0.01</u> |
| 1 meter = | 39.370 08 | 3.280 840 | 1.093 613 | 0.000 621 371 2 | <u>100</u> | <u>1</u> |

Units of Length - Survey Measure⁸ Measure⁹

| Units | Links | Feet | Rods | Chains | Miles | Meters |
|-----------|--------------|--------------|--------------|--------------|------------------|-------------|
| 1 link = | <u>1</u> | <u>0.66</u> | <u>0.04</u> | <u>0.01</u> | <u>0.000 125</u> | 0.201 168 4 |
| 1 foot = | 1.515 152 | <u>1</u> | 0.060 606 06 | 0.015 151 52 | 0.000 189 393 9 | 0.304 800 6 |
| 1 rod = | <u>25</u> | <u>16.5</u> | <u>1</u> | <u>0.25</u> | <u>0.003 125</u> | 5.029 210 |
| 1 chain = | <u>100</u> | <u>66</u> | <u>4</u> | <u>1</u> | <u>0.0125</u> | 20.116 84 |
| 1 mile = | <u>8 000</u> | <u>5 280</u> | <u>320</u> | <u>80</u> | <u>1</u> | 1609.347 |
| 1 meter = | 4.970 960 | 3.280 833 | 0.198 838 4 | 0.049 709 60 | 0.000 621 369 9 | <u>1</u> |

⁸ ¹⁴ One international foot
One international mile

= 0.999 998 survey foot (exactly)
= 0.999 998 survey mile (exactly)

Units of Area - International Measure¹⁵
(all underlined figures are exact)

| Units | Square Inches | Square Feet | Square Yards |
|-----------------------|----------------------|-------------------|------------------|
| 1 square inch = | <u>1</u> | 0.006 944 444 | 0.000 771 604 9 |
| 1 square foot = | <u>144</u> | <u>1</u> | 0.111 111 1 |
| 1 square yard = | <u>1 296</u> | <u>9</u> | <u>1</u> |
| 1 square mile = | <u>4 014 489 600</u> | <u>27 878 400</u> | <u>3 097 600</u> |
| 1 square centimeter = | 0.155 000 3 | 0.001 076 391 | 0.000 119 599 0 |
| 1 square meter = | 1550.003 | 10.763 91 | 1.195 990 |

Note: 1 survey foot = $\frac{1200}{3937}$ meter (exactly)
 1 international foot = 12 x 0.0254 meter (exactly)

| |
|--|
| Note: 1 survey foot = $\frac{1200}{3937}$ meter (exactly) |
| 1 international foot = 12 x 0.0254 meter (exactly) |
| 1 international foot = 0.0254 x 39.37 survey foot (exactly) |

| Units | Square Miles | Square Centimeters | Square Meters |
|-----------------------|--------------------------|--------------------------|--------------------------|
| 1 square inch = | 0.000 000 000 249 097 7 | <u>6.451 6</u> | <u>0.000 645 16</u> |
| 1 square foot = | 0.000 000 035 870 06 | <u>929.030 4</u> | <u>0.092 903 04</u> |
| 1 square yard = | 0.000 000 322 830 6 | <u>8361.273 6</u> | <u>0.836 127 36</u> |
| 1 square mile = | <u>1</u> | <u>25 899 881 103.36</u> | <u>2 589 988.110 336</u> |
| 1 square centimeter = | 0.000 000 000 038 610 22 | <u>1</u> | <u>0.0001</u> |
| 1 square meter = | 0.000 000 386 102 2 | <u>10 000</u> | <u>1</u> |

Units of Area - Survey Measure⁹ Measure¹⁰

| Units | Square Feet | Square Rods | Square Chains | Acres |
|------------------|-------------------|----------------|-----------------|------------------|
| 1 square foot = | <u>1</u> | 0.003 673 095 | 0.000 229 568 4 | 0.000 022 956 84 |
| 1 square rod = | <u>272.25</u> | <u>1</u> | <u>0.062 5</u> | <u>0.006 25</u> |
| 1 square chain = | <u>43564 356</u> | <u>16</u> | <u>1</u> | <u>0.1</u> |
| 1 acre = | <u>43 560</u> | <u>160</u> | <u>10</u> | <u>1</u> |
| 1 square mile = | <u>27 878 400</u> | <u>102 400</u> | <u>6 400</u> | <u>640</u> |
| 1 square meter = | 10.763 87 | 0.039 536 70 | 0.002 471 044 | 0.000 247 104 4 |
| 1 hectare = | 107 638.7 | 395.367 0 | 24.710 44 | 2.471 044 |

⁹⁻¹⁵ One square survey foot
 One square survey mile

= 1.000 004 square international feet
 = 1.000 004 square international miles

| Units | Square Miles | Square Meters | Hectares |
|------------------|--------------------------|----------------------|-------------------|
| 1 square foot = | 0.000 000 035 870 06 | 0.092 903 41 | 0.000 009 290 341 |
| 1 square rod = | <u>0.000 009 765 625</u> | 25.292 95 | 0.002 529 295 |
| 1 square chain = | <u>0.000 156 25</u> | 404.687 3 | 0.040 468 73 |
| 1 acre = | <u>0.001 562 5</u> | 4 046.873 | 0.404 687 3 |
| 1 square mile = | <u>1</u> | 2 589 998 | 258.999 8 |
| 1 square meter = | 0.000 000 386 100 6 | <u>1</u> | <u>0.000 1</u> |
| 1 hectare = | 0.003 861 006 | <u>10 000</u> | <u>1</u> |

⁹ ~~One square survey foot = 1.000 004 square international feet~~
~~One square survey mile = 1.000 004 square international miles~~

Units of Volume
(all underlined figures are exact)

| Units | Cubic Inches | Cubic Feet | Cubic Yards |
|----------------------|---------------|------------------|-------------------|
| 1 cubic inch = | <u>1</u> | 0.000 578 703 7 | 0.000 021 433 47 |
| 1 cubic foot = | <u>1 728</u> | <u>1</u> | 0.037 037 04 |
| 1 cubic yard = | <u>46 656</u> | <u>27</u> | <u>1</u> |
| 1 cubic centimeter = | 0.061 023 74 | 0.000 035 314 67 | 0.000 001 307 951 |
| 1 cubic decimeter = | 61.023 74 | 0.035 314 67 | 0.001 307 951 |
| 1 cubic meter = | 61 023.74 | 35.314 67 | 1.307 951 |

| Units | Milliliters (Cubic Centimeters) | Liters (Cubic Decimeters) | Cubic Meters |
|----------------------|------------------------------------|------------------------------|--------------------------|
| 1 cubic inch = | <u>16.387 064</u> | <u>0.016 387 064</u> | <u>0.000 016 387 064</u> |
| 1 cubic foot = | <u>28 316.846 592</u> | <u>28.316 846 592</u> | <u>0.028 316 846 592</u> |
| 1 cubic yard = | <u>764 554.857 984</u> | <u>764.554 857 984</u> | <u>0.764 554 857 984</u> |
| 1 cubic centimeter = | <u>1</u> | <u>0.001</u> | <u>0.000 001</u> |
| 1 cubic decimeter = | <u>1 000</u> | <u>1</u> | <u>0.001</u> |
| 1 cubic meter = | <u>1 000 000</u> | <u>1000</u> | <u>1</u> |

Units of Capacity or Volume - Dry Volume Measure

| Units | Dry Pints | Dry Quarts | Pecks | Bushels |
|-----------------|-------------|-------------|----------------|------------------|
| 1 dry pint = | <u>1</u> | <u>0.5</u> | <u>0.062 5</u> | <u>0.015 625</u> |
| 1 dry quart = | <u>2</u> | <u>1</u> | <u>0.125</u> | <u>0.031 25</u> |
| 1 peck = | <u>16</u> | <u>8</u> | <u>1</u> | <u>0.25</u> |
| 1 bushel = | <u>64</u> | <u>32</u> | <u>4</u> | <u>1</u> |
| 1 cubic inch = | 0.029 761 6 | 0.014 880 8 | 0.001 860 10 | 0.000 465 025 |
| 1 cubic foot = | 51.428 09 | 25.714 05 | 3.214 256 | 0.803 563 95 |
| 1 liter = | 1.816 166 | 0.908 083 0 | 0.113 510 4 | 0.028 377 59 |
| 1 cubic meter = | 1 816.166 | 908.083 0 | 113.510 4 | 28.377 59 |

| Units | Cubic Inches | Cubic Feet | Liters | Cubic Meters |
|----------------|---------------------|-----------------|--------------------------|-----------------------------|
| 1 dry pint = | <u>33.600 312 5</u> | 0.019 444 63 | 0.550 610 5 | 0.000 550 610 5 |
| 1 dry quart = | <u>67.200 625</u> | 0.038 889 25 | 1.101 221 | 0.001 101 221 |
| 1 peck = | <u>537.605</u> | 0.311 114 | 8.809 768 | 0.008 809 768 |
| 1 bushel = | <u>2 150.42</u> | 1.244 456 | <u>35.239 070 166 88</u> | <u>0.035 239 070 166 88</u> |
| 1 cubic inch = | <u>1</u> | 0.000 578 703 7 | <u>0.016 387 064</u> | <u>0.000 016 387 064</u> |

| Units | Cubic Inches | Cubic Feet | Liters | Cubic Meters |
|-----------------|--------------|--------------|----------------|--------------------------|
| 1 cubic foot = | <u>1728</u> | <u>1</u> | 28.316 846 592 | <u>0.028 316 846 592</u> |
| 1 liter = | 61.023 74 | 0.035 314 67 | <u>1</u> | <u>0.001</u> |
| 1 cubic meter = | 61 023.74 | 35.314 67 | 1000 | <u>1</u> |

Units of Capacity or Volume - Liquid Volume Measure
(All underlined figures are exact)

| Units | Minims | Fluid Drams | Fluid Ounces | Gills |
|------------------|---------------|--------------|---------------|-----------------|
| 1 minim = | <u>1</u> | 0.016 666 67 | 0.002 083 333 | 0.000 520 833 3 |
| 1 fluid dram = | <u>60</u> | <u>1</u> | <u>0.125</u> | <u>0.031 25</u> |
| 1 fluid ounce = | <u>480</u> | <u>8</u> | <u>1</u> | <u>0.25</u> |
| 1 gill = | <u>1 920</u> | <u>32</u> | <u>4</u> | <u>1</u> |
| 1 liquid pint = | <u>7 680</u> | <u>128</u> | <u>16</u> | <u>4</u> |
| 1 liquid quart = | <u>15 360</u> | <u>256</u> | <u>32</u> | <u>8</u> |
| 1 gallon = | <u>61 440</u> | <u>1024</u> | <u>128</u> | <u>32</u> |
| 1 cubic inch = | 265.974 0 | 4.432 900 | 0.554 112 6 | 0.138 528 1 |
| 1 cubic foot = | 459 603.1 | 7660.052 | 957.506 5 | 239.376 6 |
| 1 milliliter = | 16.230 73 | 0.270 512 2 | 0.033 814 02 | 0.008 453 506 |
| 1 liter = | 16 230.73 | 270.512 2 | 33.814 02 | 8.453 506 |

| Units | Liquid Pints | Liquid Quarts | Gallons | Cubic Inches |
|------------------|--------------------|---------------------|------------------------|--------------------|
| 1 minim = | 0.000 130 208 3 | 0.000 065 104 17 | 0.000 016 276 04 | 0.003 759 766 |
| 1 fluid dram = | <u>0.007 812 5</u> | <u>0.003 906 25</u> | <u>0.000 976 562 5</u> | 0.225 585 94 |
| 1 fluid ounce = | <u>0.062 5</u> | <u>0.031 25</u> | <u>0.007 812 5</u> | <u>1.804 687 5</u> |
| 1 gill = | <u>0.25</u> | <u>0.125</u> | <u>0.031 25</u> | <u>7.218 75</u> |
| 1 liquid pint = | <u>1</u> | <u>0.5</u> | <u>0.125</u> | <u>28.875</u> |
| 1 liquid quart = | <u>2</u> | <u>1</u> | <u>0.25</u> | <u>57.75</u> |
| 1 gallon = | <u>8</u> | <u>4</u> | <u>1</u> | <u>231</u> |
| 1 cubic inch = | 0.034 632 03 | 0.017 316 02 | 0.004 329 004 | <u>1</u> |
| 1 cubic foot = | 59.844 16 | 29.922 08 | 7.480 519 | <u>1 728</u> |
| 1 milliliter = | 0.002 113 376 | 0.001 056 688 | 0.000 264 172 1 | 0.061 023 74 |
| 1 liter = | 2.113 376 | 1.056 688 | 0.264 172 1 | 61.023 74 |

| Units | Cubic Feet | Milliliters | Liters |
|------------------|-------------------|-----------------------|----------------------|
| 1 minim = | 0.000 002 175 790 | 0.061 611 52 | 0.000 061 611 52 |
| 1 fluid dram = | 0.000 130 547 4 | 3.696 691 | 0.003 696 691 |
| 1 fluid ounce = | 0.001 044 379 | 29.573 53 | 0.029 573 53 |
| 1 gill = | 0.004 177 517 | 118.294 1 | 0.118 294 1 |
| 1 liquid pint = | 0.016 710 07 | 473.176 5 | 0.473 176 5 |
| 1 liquid quart = | 0.033 420 14 | 946.352 9 | 0.946 352 9 |
| 1 gallon = | 0.133 680 6 | <u>3785.41411 784</u> | <u>3.785 411 784</u> |
| 1 cubic inch = | 0.000 578 703 7 | 16.387 06 | 0.016 387 06 |
| 1 cubic foot = | <u>1</u> | 28 316.85 | 28.316 85 |
| 1 milliliter = | 0.000 035 314 67 | <u>1</u> | <u>0.001</u> |
| 1 liter = | 0.035 314 67 | <u>1 000</u> | <u>1</u> |

Units of Mass Not Less Than Avoirdupois Ounces
(all underlined figures are exact)

| Units | Avoirdupois Ounces | Avoirdupois Pounds | Short Hundred-weights | Short Tons |
|-------------------------|--------------------|--------------------|-----------------------|---------------------|
| 1 avoirdupois ounce = | <u>1</u> | <u>0.0625</u> | <u>0.000 625</u> | <u>0.000 031 25</u> |
| 1 avoirdupois pound = | <u>16</u> | <u>1</u> | <u>0.01</u> | <u>0.000 5</u> |
| 1 short hundredweight = | <u>1 600</u> | <u>100</u> | <u>1</u> | <u>0.05</u> |
| 1 short ton = | <u>32 000</u> | <u>2 000</u> | <u>20</u> | <u>1</u> |
| 1 long ton = | <u>35 840</u> | <u>2 240</u> | <u>22.4</u> | <u>1.12</u> |
| 1 kilogram = | 35.273 96 | 2.204 623 | 0.022 046 23 | 0.001 102 311 |
| 1 metric ton = | 35 273.96 | 2204.623 | 22.046 23 | 1.102 311 |

| Units | Long Tons | Kilograms | Metric Tons |
|-------------------------|------------------|--------------------------|------------------------------|
| 1 avoirdupois ounce = | 0.000 027 901 79 | <u>0.028 349 523 125</u> | <u>0.000 028 349 523 125</u> |
| 1 avoirdupois pound = | 0.000 446 428 6 | <u>0.453 592 37</u> | <u>0.000 453 592 37</u> |
| 1 short hundredweight = | 0.044 642 86 | <u>45.359 237</u> | <u>0.045 359 237</u> |
| 1 short ton = | 0.892 857 1 | <u>907.184 74</u> | <u>0.907 184 74</u> |
| 1 long ton = | <u>1</u> | <u>1016.046 908 8</u> | <u>1.016 046 908 8</u> |
| 1 kilogram = | 0.000 984 206 5 | <u>1</u> | <u>0.001</u> |
| 1 metric ton = | 0.984 206 5 | <u>1 000</u> | <u>1</u> |

Units of Mass Not Greater Than Pounds and Kilograms
(all underlined figures are exact)

| Units | Grains | Apothecaries Scruples | Pennyweights | Avoirdupois Drams |
|--------------------------|------------------|--------------------------|-----------------|----------------------|
| 1 grain = | <u>1</u> | <u>0.05</u> | 0.041 666 67 | 0.036 571 43 |
| 1 apoth. scruple = | <u>20</u> | <u>1</u> | 0.833 333 3 | 0.731 428 6 |
| 1 pennyweight = | <u>24</u> | <u>1.2</u> | <u>1</u> | 0.877 714 3 |
| 1 avdp. dram = | <u>27.343 75</u> | <u>1.367 187 5</u> | 1.139 323 | <u>1</u> |
| 1 apoth. dram = | <u>60</u> | <u>3</u> | <u>2.5</u> | 2.194 286 |
| 1 avdp. ounce = | <u>437.5</u> | <u>21.875</u> | 18.229 17 | <u>16</u> |
| 1 apoth. or troy oz. = | <u>480</u> | <u>24</u> | <u>20</u> | 17.554 29 |
| 1 apoth. or troy pound = | <u>5 760</u> | <u>288</u> | <u>240</u> | 210.651 4 |
| 1 avdp. pound = | <u>7 000</u> | <u>350</u> | 291.666 7 | <u>256</u> |
| 1 milligram = | 0.015 432 36 | 0.000 771 617 9 | 0.000 643 014 9 | 0.000 564 383 4 |
| 1 gram = | 15.432 36 | 0.771 617 9 | 0.643 014 9 | 0.564 383 4 |
| 1 kilogram = | 15432.36 | 771.617 9 | 643.014 9 | 564.383 4 |

| Units | Apothecaries Drams | Avoirdupois Ounces | Apothecaries or Troy Ounces | Apothecaries or Troy Pounds |
|--------------------------|-----------------------|-----------------------|--------------------------------|--------------------------------|
| 1 grain = | 0.016 666 67 | 0.002 285 714 | 0.002 083 333 | 0.000 173 611 1 |
| 1 apoth. scruple = | 0.333 333 3 | 0.045 714 29 | 0.041 666 67 | 0.003 472 222 |
| 1 pennyweight = | <u>0.4</u> | 0.054 857 14 | <u>0.05</u> | 0.004 166 667 |
| 1 avdp. dram = | 0.455 729 2 | <u>0.062 5</u> | 0.56 966 15 | 0.004 747 179 |
| 1 apoth. dram = | <u>1</u> | 0.137 142 9 | <u>0.125</u> | 0.010 416 67 |
| 1 avdp. ounce = | 7.291 667 | <u>1</u> | 0.911 458 3 | 0.075 954 86 |
| 1 apoth. or troy ounce = | <u>8</u> | 1.097 143 | <u>1</u> | 0.083 333 333 |
| 1 apoth. or troy pound = | <u>96</u> | 13.165 71 | <u>12</u> | <u>1</u> |
| 1 avdp. pound = | 116.666 7 | <u>16</u> | 14.583 33 | 1.215 278 |
| 1 milligram = | 0.000 257 206 0 | 0.000 035 273 96 | 0.000 032 150 75 | 0.000 002 679 229 |
| 1 gram = | 0.257 206 0 | 0.035 273 96 | 0.032 150 75 | 0.002 679 229 |
| 1 kilogram = | 257.206 0 | 35.273 96 | 32.150 75 | 2.679 229 |

| Units | Avoirdupois Pounds | Milligrams | Grams | Kilograms |
|--------------------------|--------------------|----------------------------|----------------------------|--------------------------------|
| 1 grain = | 0.000 142 857 1 | <u>64.798 91</u> | <u>0.064 798 91</u> | <u>0.000 064 798 91</u> |
| 1 apoth. scruple = | 0.002 857 143 | <u>1 295.978 2</u> | <u>1.295 978 2</u> | <u>0.001 295 978 2</u> |
| 1 pennyweight = | 0.003 428 571 | <u>1 555.173 84</u> | <u>1.555 173 84</u> | <u>0.001 555 173 84</u> |
| 1 avdp. dram = | 0.003 906 25 | <u>1 771.845 195 312 5</u> | <u>1.771 845 195 312 5</u> | <u>0.001 771 845 195 312 5</u> |
| 1 apoth. dram = | 0.008 571 429 | <u>3 887.934 6</u> | <u>3.887 934 6</u> | <u>0.003 887 934 6</u> |
| 1 avdp. ounce = | <u>0.062 5</u> | <u>28 349.523 125</u> | <u>28.349 523 125</u> | <u>0.028 349 523 125</u> |
| 1 apoth. or troy ounce = | 0.068 571 43 | <u>31 103.476 8</u> | <u>31.103 476 8</u> | <u>0.031 103 476 8</u> |
| 1 apoth. or troy pound = | 0.822 857 1 | <u>373 241.721 6</u> | <u>373.241 721 6</u> | <u>0.373 241 721 6</u> |
| 1 avdp. pound = | <u>1</u> | <u>453 592.37.37</u> | <u>453.592 37</u> | <u>0.453 592 37</u> |
| 1 milligram = | 0.000 002 204 623 | <u>1</u> | <u>0.001</u> | <u>0.000 001</u> |
| 1 gram = | 0.002 204 623 | <u>1 000</u> | <u>1</u> | <u>0.001</u> |
| 1 kilogram = | 2.204 623 | <u>1 000 000</u> | <u>1 000</u> | <u>1</u> |

5. Tables of Equivalents

In these tables it is necessary to differentiate between the “international foot” and the “survey foot.” Therefore, the survey foot is underlined.

When the name of a unit is enclosed in brackets (thus, [1 hand] . . .), this indicates (1) that the unit is not in general current use in the United States, or (2) that the unit is believed to be based on “custom and usage” rather than on formal authoritative definition.

Equivalents involving decimals are, in most instances, rounded off to the third decimal place except where they are exact, in which cases these exact equivalents are so designated. The equivalents of the imprecise units “tablespoon” and “teaspoon” are rounded to the nearest milliliter.

| Units of Length | |
|---|---|
| angstrom (\AA) ¹⁶ | 0.1 nanometer (exactly) 0.000 1 micrometer (exactly) 0.000 000 1 millimeter (exactly) 0.000 000 004 inch |
| 1 cable’s length | 120 fathoms (exactly) 720 <u>feet</u> (exactly) 219 meters |

¹⁶ The angstrom is basically defined as 10^{-10} meter.

| Units of Length | |
|--|---|
| 1 centimeter (cm) | 0.393 7 inch |
| 1 chain (ch) (Gunter’s or surveyors) | 66 <u>feet</u> (exactly) 20.116 8 meters |
| 1 decimeter (dm) | 3.937 inches |
| 1 dekameter (dam) | 32.808 feet |
| 1 fathom | 6 <u>feet</u> (exactly) 1.828 8 meters |
| 1 foot (ft) | 0.304 8 meter (exactly) |
| 1 furlong (fur) | 10 chains (surveyors) (exactly) 660 <u>feet</u> (exactly) $\frac{1}{8}$ U.S. statute mile (exactly) 201.168 meters |
| [1 hand] | 4 inches |
| 1 inch (in) | 2.54 centimeters (exactly) |
| 1 kilometer (km) | 0.621 mile |
| 1 league (land) | 3 U.S. statute miles (exactly) 4.828 kilometers |
| 1 link (li) (Gunter’s or surveyors) | 0.66 <u>foot</u> (exactly) 0.201 168 meter |
| 1 meter (m) | 39.37 inches 1.094 yards |
| 1 micrometer | 0.001 millimeter (exactly) 0.000 039 37 inch |
| 1 mil | 0.001 inch (exactly) 0.025 4 millimeter (exactly) |
| 1 mile (mi) (U.S. statute) ¹⁷ | 5280 <u>feet</u> survey (exactly) 1.609 kilometers |
| 1 mile (mi) (international) | 5280 feet international (exactly) |
| 1 mile (mi) (international nautical) ¹⁸ | 1.852 kilometers (exactly) 1.151 survey miles |
| 1 millimeter (mm) | 0.039 37 inch 0.001 meter (exactly) |
| 1 nanometer (nm) | 0.000 000 039 37 inch |
| 1 Point (typography) | 0.013 837 inch (exactly) |

¹⁷ The term “statute mile” originated with Queen Elizabeth I who changed the definition of the mile from the Roman mile of 5000 feet to the statute mile of 5280 feet. The international mile and the U.S. statute mile differ by about 3 millimeters although both are defined as being equal to 5280 feet. The international mile is based on the international foot (0.3048 meter) whereas the U.S. statute mile is based on the survey foot (1200/3937 meter).

¹⁸ The international nautical mile of 1852 meters (6076.115 49 feet) was adopted effective July 1, 1954, for use in the United States. The value formerly used in the United States was 6080.20 feet = 1 nautical (geographical or sea) mile.

| Units of Length | |
|----------------------------|---|
| | $\frac{1}{72}$ inch (approximately) 0.351 millimeter |
| 1 rod (rd), pole, or perch | 16½ feet (exactly) 5.029 2 meters |
| 1 yard (yd) | 0.914 4 meter (exactly) |

| Units of Area | |
|---|---|
| 1 acre ¹⁹ | 43 560 square feet (exactly) 0.405 hectare |
| 1 are | 119.599 square yards 0.025 acre |
| 1 hectare | 2.471 acres |
| [1 square (building)] | 100 square feet |
| 1 square centimeter (cm ²) | 0.155 square inch |
| 1 square decimeter (dm ²) | 15.500 square inches |
| 1 square foot (ft ²) | 929.030 square centimeters |
| 1 square inch (in ²) | 6.451 6 square centimeters (exactly) |
| 1 square kilometer (km ²) | 247.104 acres 0.386 square mile |
| 1 square meter (m ²) | 1.196 square yards 10.764 square feet |
| 1 square mile (mi ²) | 258.999 hectares |
| 1 square millimeter (mm ²) | 0.002 square inch |
| 1 square rod (rd ²), sq pole, or sq perch | 25.293 square meters |
| 1 square yard (yd ²) | 0.836 square meter |

| Units of Capacity or Volume | |
|--|--|
| 1 barrel (bbl), liquid | 31 to 42 gallons ²⁰ |
| 1 barrel (bbl), standard for fruits, vegetables, and other dry commodities, except cranberries | 7056 cubic inches 105 dry quarts 3.281 bushels, struck measure |
| 1 barrel (bbl), standard, cranberry | 5826 cubic inches |

¹⁹ The question is often asked as to the length of a side of an acre of ground. An acre is a unit of area containing 43 560 square feet. It is not necessarily square, or even rectangular. But, if it is square, then the length of a side is equal to $\sqrt{43560 \text{ ft}^2} = 208.710 \text{ ft}$ $\sqrt{43560 \text{ ft}^2} = 208.710 \text{ ft}$ (not exact).

²⁰ There are a variety of “barrels” established by law or usage. For example, federal taxes on fermented liquors are based on a barrel of 31 gallons; many state laws fix the “barrel for liquids” as 31½ gallons; one state fixes a 36-gallon barrel for cistern measurement; federal law recognizes a 40-gallon barrel for “proof spirits;” by custom, 42 gallons comprise a barrel of crude oil or petroleum products for statistical purposes, and this equivalent is recognized “for liquids” by four states.

| Units of Capacity or Volume | |
|---|---|
| | 86 ⁴⁵ / ₆₄ dry quarts 2.709 bushels, struck measure |
| 1 bushel (bu) (U.S.) struck measure | 2150.42 cubic inches (exactly) 35.238 liters |
| [1 bushel, heaped (U.S.)] | 2747.715 cubic inches 1.278 bushels, struck measure ²¹ |
| [1 bushel (bu) (British Imperial) (struck measure)] | 1.032 U.S. bushels, struck measure 2219.36 cubic inches |
| 1 cord (cd) (firewood) | 128 cubic feet (exactly) |
| 1 cubic centimeter (cm ³) | 0.061 cubic inch |
| 1 cubic decimeter (dm ³) | 61.024 cubic inches |
| 1 cubic foot (ft ³) | 7.481 gallons 28.316 cubic decimeters |
| 1 cubic inch (in ³) | 0.554 fluid ounce 4.433 fluid drams 16.387 cubic centimeters |
| 1 cubic meter (m ³) | 1.308 cubic yards |
| 1 cubic yard (yd ³) | 0.765 cubic meter |
| 1 cup, measuring | 8 fluid ounces (exactly) 237 milliliters ½ liquid pint (exactly) |
| 1 dekaliter (daL) | 2.642 gallons 1.135 pecks |
| 1 dram, fluid (or liquid) (fl dr) or <i>f 3</i> (U.S.) | ¹ / ₈ fluid ounce (exactly) 0.226 cubic inch 3.697 milliliters 1.041 British fluid drachms |
| [1 drachm, fluid (fl dr) (British)] | 0.961 U.S. fluid dram 0.217 cubic inch 3.552 milliliters |
| 1 gallon (gal) (U.S.) | 231 cubic inches (exactly) 3.785 liters 0.833 British gallon 128 U.S. fluid ounces (exactly) |
| [1 gallon (gal) (British Imperial)] | 277.42 cubic inches 1.201 U.S. gallons 4.546 liters 160 British fluid ounces (exactly) |
| 1 gill (gi) | 7.219 cubic inches 4 fluid ounces (exactly) 0.118 liter |
| 1 hectoliter (hL) | 26.418 gallons |

⁴⁵/₂₁ Frequently recognized as 1¼ bushels, struck measure.

| Units of Capacity or Volume | |
|---|---|
| | 2.838 bushels |
| 1 liter (1 cubic decimeter exactly) | 1.057 liquid quarts 0.908 dry quart 61.025 cubic inches |
| 1 milliliter (mL) | 0.271 fluid dram 16.231 minims 0.061 cubic inch |
| 1 ounce, fluid (or liquid) (fl oz) or $f \frac{5}{8}$) (U.S.) | 1.805 cubic inches 29.573 milliliters 1.041 British fluid ounces |
| [1 ounce, fluid (fl oz) (British)] | 0.961 U.S. fluid ounce 1.734 cubic inches 28.412 milliliters |
| 1 peck (pk) | 8.810 liters |
| 1 pint (pt), dry | 33.600 cubic inches 0.551 liter |
| 1 pint (pt), liquid | 28.875 cubic inches exactly 0.473 liter |
| 1 quart (qt), dry (U.S.) | 67.201 cubic inches 1.101 liters 0.969 British quart |
| 1 quart (qt), liquid (U.S.) | 57.75 cubic inches (exactly) 0.946 liter 0.833 British quart |
| [1 quart (qt) (British)] | 69.354 cubic inches 1.032 U.S. dry quarts 1.201 U.S. liquid quarts |
| 1 tablespoon, measuring | 3 teaspoons (exactly) 15 milliliters 4 fluid drams $\frac{1}{2}$ fluid ounce (exactly) |
| 1 teaspoon, measuring | $\frac{1}{3}$ tablespoon (exactly) 5 milliliters $1\frac{1}{3}$ fluid drams ²² |
| 1 water ton (English) | 270.91 U.S. gallons 224 British Imperial gallons (exactly) |

^{46 22}The equivalent “1 teaspoon = $1\frac{1}{3}$ fluid drams” has been found by the Bureau to correspond more closely with the actual capacities of “measuring” and silver teaspoons than the equivalent “1 teaspoon = 1 fluid dram,” which is given by a number of dictionaries.

| Units of Mass | |
|--|--|
| 1 assay ton ²³ -(AT) ²⁴ | 29.167 grams |
| 1 carat (c) | 200 milligrams (exactly) 3.086 grains |
| 1 dram apothecaries (dr ap or ℥) | 60 grains (exactly) 3.888 grams |
| 1 dram avoirdupois (dr avdp) | 27 ¹¹ /32 (= 27.344) grains 1.772 grams |
| 1 gamma (γ) | 1 microgram (exactly) |
| 1 grain | 64.798 91 milligrams (exactly) |
| 1 gram (g) | 15.432 grains 0.035 ounce, avoirdupois |
| 1 hundredweight, gross or long ²⁵ (gross cwt) | 112 pounds (exactly) 50.802 kilograms |
| 1 hundredweight, gross or short (cwt or net cwt) | 100 pounds (exactly) 45.359 kilograms |
| 1 kilogram (kg) | 2.205 pounds |
| 1 milligram (mg) | 0.015 grain |
| 1 ounce, avoirdupois (oz avdp) | 437.5 grains (exactly) 0.911 troy or apothecaries ounce 28.350 grams |
| 1 ounce, troy or apothecaries (oz t or oz ap ap or ℥) | 480 grains (exactly) 1.097 avoirdupois ounces 31.103 grams |
| 1 pennyweight (dwt) | 1.555 grams |
| 1 point | 0.01 carat 2 milligrams |
| 1 pound, avoirdupois (lb avdp) | 7000 grains (exactly) 1.215 troy or apothecaries pounds 453.592 37 grams (exactly) |
| 1 micropound (μlb) [the Greek letter mu in combination with the letters lb] | 0.000 001 pound (exactly) |
| 1 pound, troy or apothecaries (lb t or lb ap) | 5760 grains (exactly) 0.823 avoirdupois pound 373.242 grams |

¹⁷Used in assaying. The assay ton bears the same relation to the milligram that a ton of 2000 pounds avoirdupois bears to the ounce troy; hence the mass in milligrams of precious metal obtained from one assay ton of ore gives directly the number of troy ounces to the net ton.

²⁴Used in assaying. The assay ton bears the same relation to the milligram that a ton of 2000 pounds avoirdupois bears to the ounce troy; hence the mass in milligrams of precious metal obtained from one assay ton of ore gives directly the number of troy ounces to the net ton.

¹⁸⁻²⁵The gross or long ton and hundredweight are used commercially in the United~~Untied~~ States to only a very limited~~limited~~ extent, usually in restricted industrial fields. The units are the same as the British “ton” and “hundredweight.”the “hundredweights.”

| Units of Mass | |
|--|---|
| 1 scruple (s ap or ℥) | 20 grains (exactly) 1.296 grams |
| 1 ton, gross or long ²⁶ | 2240 pounds (exactly) 1.12 net tons (exactly) 1.016 metric tons |
| 1 ton, metric (t) | 2204.623 pounds 0.984 gross ton 1.102 net tons |
| 1 ton, net or short (tn) ²¹ | 2000 pounds (exactly) 0.893 gross ton 0.907 metric ton |

¹⁹

²⁰The gross or long ton and hundredweight are used commercially in the United States to a limited extent only, usually in restricted industrial fields. These units are the same as the British “ton” and “hundredweight.”

²¹ **As of January 1, 2014, “tn” is the required abbreviation for “short ton.” Devices manufactured between January 1, 2008, and December 31, 2013, may use an abbreviation other than “tn” to specify “short ton.”**

MARKUP COPY

Appendix D. Definitions

The specific code to which the definition applies is shown in [brackets] at the end of the definition. Definitions for the General Code [1.10] apply to all codes in Handbook 44.

A

absolute value. – The absolute value of a number is the magnitude of that number without considering the positive or negative sign.[2.20]

acceptance test. – The first official test of a farm milk tank, at a particular location, in which the tank is accepted as correct. This test applies to newly constructed tanks, relocated used tanks, and recalibrated tanks.[4.42]

accurate. – A piece of equipment is “accurate” when its performance or value – that is, its indications, its deliveries, its recorded representations, or its capacity or actual value, etc., as determined by tests made with suitable standards - conforms to the standard within the applicable tolerances and other performance requirements. Equipment that fails so to conform is “inaccurate.” (See also Also see “correct?”) [Appendix A]

all-class. – A description of a multi-class calibration that includes all the classes of a grain type.[5.56(a), 5.57]
(Added 2007)

analog or digital recorder. – An element used with a belt-conveyor scale that continuously records the rate-of-flow of bulk material over the scale (formerly referred to as a chart recorder).[2.21]
(Amended 1989)

analog type. – A system of indication or recording in which values are presented as a series of graduations in combination with an indicator, or in which the most sensitive element of an indicating system moves continuously during the operation of the device.[1.10]

animal scale. – A scale designed for weighing single heads of livestock.[2.20]
(Amended 1987)

apparent mass versus 8.0 g/cm³. – The apparent mass of an object versus 8.0 g/cm³ is the mass of material of density 8.0 g/cm³ that produces exactly the same balance reading as the object when the comparison is made in air with a density of 1.2 mg/cm³ at 20 °C.[3.37]

approval seal. – A label, tag, stamped or etched impression, or the like, indicating official approval of a device. (Also see “security seal.”)[1.10]

assumed atmospheric pressure. – The average atmospheric pressure agreed to exist at the meter at various ranges of elevation, irrespective of variations in atmospheric pressure from time to time.[3.33]

audit trail. – An electronic count and/or information record of the changes to the values of the calibration or configuration parameters of a device.[1.10, 2.20, 2.21, 2.24, 3.30, 3.37, 5.56(a)]
(Added 1993)

automatic bulk weighing system. – A weighing system adapted to the automatic weighing of bulk commodities in successive drafts of predetermined amounts, automatically recording the no-load and loaded weight values and accumulating the net weight of each draft.[2.2022]

automatic checkweigher. – An automatic weighing system that does not require the intervention of an operator during the weighing process and used to subdivide items of different weights into one or more subgroups, such as identifying packages that have acceptable or unacceptable fill levels according to the value of the difference between

their weight and a pre-determined set point. These systems may be used to fill standard packages for compliance with net weight requirements.[2.24]

(Amended 2004)

automatic gravimetric filling machine (instrument). – A filling machine or instrument that fills containers or packages with predetermined and virtually constant mass of product from bulk by automatic weighing, and which comprises essentially an automatic feeding device or devices associated with one or more weighing unit and the appropriate discharge devices.[2.24]

(Added 2004)

automatic hopper scale. – One adapted to the automatic weighing of bulk commodity in successive drafts of predetermined amounts. (This is not an “automatic-indicating scale” defined below.)[2.20]

automatic temperature or density compensation. – The use of integrated or ancillary equipment to obtain from the output of a volumetric meter an equivalent mass, or an equivalent liquid volume at the assigned reference temperature below and a pressure of 14.696 lb/in² absolute.

Cryogenic liquids: 21 °C (70 °F)[3.34]

Hydrocarbon gas vapor: 15 °C (60 °F)[3.33]

Liquid carbon dioxide: 21 °C (70 °F)[3.38]

Liquefied petroleum gas (LPG) and Anhydrous ammonia: 15 °C (60 °F)[3.32]

Petroleum liquid fuels and lubricants: 15 °C (60 °F)[3.30]

automatic weighing system (AWS). – An automatic weighing system is a weighing device that, in combination with other hardware and/or software components, automatically weighs discrete items and that does not require the intervention of an operator during the weighing process. Examples include, but are not limited to, weigh-labelers and checkweighers.[2.24]

(Amended 2004)

automatic zero-setting mechanism (AZSM). – See “automatic zero-setting mechanism” under “zero-setting mechanism.”[2.22]

(Amended 2010)

automatic zero-setting mechanism (belt-conveyor scale). – A zero setting device that operates automatically without intervention of the operator after the belt has been running empty.[2.21]

(Added 2002)

automatic zero-tracking (AZT) mechanism. – Automatic means provided to maintain the zero balance indication, within specified limits, without the intervention of an operator.[2.20, 2.22, 2.24]

(Amended 2010)

automatic-indicating scale. – One on which the weights of applied loads of various magnitudes are automatically indicated throughout all or a portion of the weighing range of the scale. (A scale that automatically weighs out commodity in predetermined drafts, such as an automatic hopper scale, a packaging scale, and the like, is not an “automatic-indicating” scale.)[2.20, 2.22]

auxiliary indicator. – Any indicator other than the master weight totalizer that indicates the weight of material determined by the scale.[2.21]

axle-load scale. – A scale permanently installed in a fixed location, having a load-receiving element specially adapted to determine the combined load of all wheels (1) on a single axle or (2) on a tandem axle of a highway vehicle.[2.20]

B

badge. – A metal plate affixed to the meter by the manufacturer showing the manufacturer’s name, serial number and model number of the meter, and its rated capacity.[3.33]

balance, zero-load. – See “zero-load balance.”[2.20]

balance indicator. – A combination of elements, one or both of which will oscillate with respect to the other, for indicating the balance condition of a nonautomatic indicating scale. The combination may consist of two indicating edges, lines, or points, or a single edge, line, or point and a graduated scale.[2.20]

balancing mechanism. – A mechanism (including a balance ball) that is designed for adjusting a scale to an accurate zero-load balance condition.[2.20]

base pressure. – The absolute pressure used in defining the gas measurement unit to be used, and is the gauge pressure at the meter plus an agreed atmospheric pressure.[3.33]

basic distance rate. – The charge for distance for all intervals except the initial interval.[5.54]

basic time rate. – The charge for time for all intervals except the initial interval.[5.54]

basic tolerances. – Basic tolerances are those tolerances on underregistration and on overregistration, or in excess and in deficiency, that are established by a particular code for a particular device under all normal tests, whether maintenance or acceptance. Basic tolerances include minimum tolerance values when these are specified. Special tolerances, identified as such and pertaining to special tests, are not basic tolerances.[1.10]

batching meter. – A device used for the purpose of measuring quantities of water to be used in a batching operation.[3.36]

beam. – See “weighbeam.”[2.20]

beam scale. – One on which the weights of loads of various magnitudes are indicated solely by means of one or more weighbeam bars either alone or in combination with counterpoise weights.[2.20]

bell prover. – A calibrated cylindrical metal tank of the annular type with a scale thereon that, in the downward travel in a surrounding tank containing a sealing medium, displaces air through the meter being proved or calibrated.[3.33]

belt-conveyor. – An endless moving belt for transporting material from place to place.[2.21]

belt-conveyor scale. – A device that employs a weighing element in contact with a belt to sense the weight of the material being conveyed and the speed (travel) of the material, and integrates these values to produce total delivered weight.[2.21]

belt-conveyor scale systems area. – The scale system area refers to the scale suspension, weigh idlers attached to the scale suspension, 5 approach (-) idlers, and 5 retreat (+) idlers.[2.21]

(Added 2001)

belt load. – The weight of the material carried by the conveyor belt, expressed in terms of weight units per unit of length (e.g., pounds per foot, kilograms per meter). Also called “belt loading.”[2.21]

(Added 2013)

belt revolution. – The amount of conveyor belt movement or travel that is equivalent to the total length of the conveyor belt. Also referred to as "belt circuit."[2.21]

(Added 2013)

billed weight. – The weight used in the computation of the freight, postal, or storage charge, whether actual weight or dimensional weight.[5.58]

binary submultiples. – Fractional parts obtained by successively dividing by the number 2. Thus, one-half, one-fourth, one-eighth, one-sixteenth, and so on, are binary submultiples.[1.10]

built-for-purpose device. – Any main device or element which was manufactured with the intent that it be used as, or part of, a weighing or measuring device or system.[1.10]

(Added 2003)

C

calibration parameter. – Any adjustable parameter that can affect measurement or performance accuracy and, due to its nature, needs to be updated on an ongoing basis to maintain device accuracy, e.g., span adjustments, linearization factors, and coarse zero adjustments.[2.20, 2.21, 2.24, 3.30, 3.37, 5.56(a)]

(Added 1993)

carbon dioxide liquid-measuring device. – A system including a mechanism or machine of (a) the meter or (b) a weighing type of device mounted on a vehicle designed to measure and deliver liquid carbon dioxide. Means may be provided to indicate automatically, for one of a series of unit prices, the total money value of the quantity measured.[3.38]

car-wash timer. – A timer used in conjunction with a coin-operated device to measure the time during which car-wash water, cleaning solutions, or waxing solutions are dispensed.[5.55]

center-reading tank. – One so designed that the gauge rod or surface gauge, when properly positioned for use, will be approximately in the vertical axis of the tank, centrally positioned with respect to the tank walls.[4.43]

cereal grain and oil seeds. – Agricultural commodities including, but not limited to, corn, wheat, oats, barley, flax, rice, sorghum, soybeans, peanuts, dry beans, safflower, sunflower, fescue seed, etc.[5.56(a), 5.56(b)]

chart recorder. – See analog or digital recorder.

(Amended 1989)

check rate. – A rate of flow usually 20 % of the capacity rate.[3.33]

checkweighing scale. – One used to verify predetermined weight within prescribed limits.[2.24]

class of grain. – Hard Red Winter Wheat as distinguished from Hard Red Spring Wheat as distinguished from Soft Red Winter Wheat, etc.[5.56(a), 5.56(b), 5.57]

clear interval between graduations. – The distance between adjacent edges of successive graduations in a series of graduations. If the graduations are “staggered,” the interval shall be measured, if necessary, between a graduation and an extension of the adjacent graduation. (Also see “minimum clear interval.”)[1.10]

cleared. – A taximeter is “cleared” when it is inoperative with respect to all fare indication, when no indication of fare or extras is shown and when all parts are in those positions in which they are designed to be when the vehicle on which the taximeter is installed is not engaged by a passenger.[5.54]

cold-tire pressure. – The pressure in a tire at ambient temperature.[5.53, 5.54]

commercial equipment. – See “equipment.”

(Added 2008)

computing scale. – One that indicates the money values of amounts of commodity weighed, at predetermined unit prices, throughout all or part of the weighing range of the scale.[2.20]

computing type or computing type device. – A device designed to indicate, in addition to weight or measure, the total money value of product weighed or measured, for one of a series of unit prices.[1.10]

concave curve. – A change in the angle of inclination of a belt conveyor where the center of the curve is above the conveyor.[2.21]

concentrated load capacity (CLC) (also referred to as Dual Tandem Axle Capacity[DTAC]). – A capacity rating of a vehicle or axle-load scale, specified by the manufacturer, defining the maximum load applied by a group of two axles with a centerline spaced 4 feet apart and an axle width of 8 feet for which the weighbridge is designed. The concentrated load capacity rating is for both test and use.[2.20]

(Added 1988) (Amended 1991, 1994, and 2003)

configuration parameter. – Any adjustable or selectable parameter for a device feature that can affect the accuracy of a transaction or can significantly increase the potential for fraudulent use of the device and, due to its nature, needs to be updated only during device installation or upon replacement of a component, e.g., division value (increment), sensor range, and units of measurement.[2.20, 2.21, 2.24, 3.30, 3.37, 5.56(a)]

(Added 1993)

consecutive-car test train. – A train consisting of cars weighed on a reference scale, then coupled consecutively and run over the coupled-in-motion railway track scale under test.[2.20]

(Added 1990)

construction materials hopper scale. – A scale adapted to weighing construction materials such as sand, gravel, cement, and hot oil.[2.20]

contract sale. – A sale where a written agreement exists, prior to the point of sale, in which both buyer and seller have accepted pricing conditions of the sale. Examples include, but are not limited to: e-commerce, club sales, or pre-purchase agreements. Any devices used in the determination of quantity must comply with NIST Handbook 44.[3.30, 3.32, 3.37]

(Added 1993) (Amended 2002)

conventional scale. – If the use of conversion tables is necessary to obtain a moisture content value, the moisture meter indicating scale is called “conventional scale.” The values indicated by the scale are dimensionless.[5.56(b)]

conversion table. – Any table, graph, slide rule, or other external device used to determine the moisture content from the value indicated by the moisture meter.[5.56(b)]

convex curve. – A change in the angle of inclination of a belt conveyor where the center of the curve is below the conveyor.[2.21]

conveyor stringers. – Support members for the conveyor on which the scale and idlers are mounted.[2.21]

correct. – A piece of equipment is “correct” when, in addition to being accurate, it meets all applicable specification requirements. Equipment that fails to meet any of the requirements for correct equipment is “incorrect.” (See also Also see “accurate.”)[Appendix A]

correction table. – Any table, graph, slide rule, or other external device used to determine the moisture content from the value indicated by the moisture meter when the indicated value is altered by a parameter not automatically corrected for in the moisture meter (for example, temperature or test weight).[5.56(b)]

counterbalance weight(s). – One intended for application near the butt of a weighbeam for zero-load balancing purposes.[2.20]

counterpoise weight(s). – A slotted or “hanger” weight intended for application near the tip of the weighbeam of a scale having a multiple greater than one.[2.20]

coupled-in-motion railroad weighing system. – A device and related installation characteristics consisting of (1) the associated approach trackage, (2) the scale (i.e., the weighing element, the load-receiving element, and the indicating element with its software), and (3) the exit trackage, which permit the weighing of railroad cars coupled in motion.[2.20, 2.23]

(Added 1992)

crane scale. – One with a nominal capacity of 5000 pounds or more designed to weigh loads while they are suspended freely from an overhead, track-mounted crane.[2.20]

cryogenic liquid-measuring device. – A system including a liquid-measuring element designed to measure and deliver cryogenic liquids in the liquid state.[3.34]

(Amended 1986 and 2003)

cryogenic liquids. – Fluids whose normal boiling point is below 120 kelvin (-243 °F).[3.34]

cubic foot, gas. – The amount of a cryogenic liquid in the gaseous state at a temperature of 70 °F and under a pressure of 14.696 lb/in² absolute that occupies one cubic foot (1 ft³). (See NTP.)[3.34]

D

“d,” dimension division value. – The smallest increment that the device displays for any axis and length of object in that axis.[5.58]

d, value scale division. – See “scale division, value of (d).”[2.20, 2.22]

D_{max} (maximum load of the measuring range). – Largest value of a quantity (mass) which is applied to a load cell during test or use. This value shall not be greater than E_{max}. [2.20]

(Added 2005)

D_{min} (minimum load of the measuring range). – Smallest value of a quantity (mass) which is applied to a load cell during test or use. This value shall not be less than E_{min}. [2.20]

(Added 2006)

dairy-product-test scale. – A scale used in determining the moisture content of butter and/or cheese or in determining the butterfat content of milk, cream, or butter.[2.20]

decimal submultiples. – Parts obtained by successively dividing by the number 10. Thus 0.1, 0.01, 0.001, and so on are decimal submultiples.[1.10]

decreasing-load test. – A test for automatic-indicating scales only, wherein the performance of the scale is tested as the load is reduced.[2.20, 2.22]

(Amended 1987)

deficiency. – See “excess and deficiency.”[1.10]

digital type. – A system of indication or recording of the selector type or one that advances intermittently in which all values are presented digitally, or in numbers. In a digital indicating or recording element, or in digital representation, there are no graduations.[1.10]

dimensional weight (or dim, weight). – A value computed by dividing the object’s volume by a conversion factor; it may be used for the calculation of charges when the value is greater than the actual weight.[5.58]
(Added 2004)

direct sale. – A sale in which both parties in the transaction are present when the quantity is being determined. An unattended automated or customer-operated weighing or measuring system is considered to represent the device/business owner in transactions involving an unattended device.[1.10]
(Amended 1993)

discharge hose. – A flexible hose connected to the discharge outlet of a measuring device or its discharge line.[3.30, 3.31, 3.32, 3.34, 3.37, 3.38]
(Added 1987)

discharge line. – A rigid pipe connected to the outlet of a measuring device.[3.30, 3.31, 3.32, 3.34, 3.37]
(Added 1987)

discrimination (of an automatic-indicating scale). – The value of the test load on the load-receiving element of the scale that will produce a specified minimum change of the indicated or recorded value on the scale.[2.20, 2.22]

dispenser. – See motor-fuel device.[3.30, 3.37]

distributed-car test train. – A train consisting of cars weighed first on a reference scale, cars coupled consecutively in groups at different locations within the train, then run over the coupled-in-motion railway track scale under test. The groups are typically placed at the front, middle, and rear of the train.[2.20]
(Added 1990)

dry hose. – A discharge hose intended to be completely drained at the end of each delivery of product. (SeeAlso see “dry-hose type.”)[3.30, 3.31]
(Amended 2002)

dry-hose type. – A type of device in which it is intended that the discharge hose be completely drained following the mechanical operations involved in each delivery. (SeeAlso see “dry hose.”)[3.30, 3.31, 3.34, 3.35]

dynamic monorail weighing system. – A weighing system which employs hardware or software to compensate for dynamic effects from the load or the system that do not exist in static weighing, in order to provide a stable indication. Dynamic factors may include shock or impact loading, system vibrations, oscillations, etc., and can occur even when the load is not moving across the load-receiving element.[2.20]
(Added 1999)

E

e, value of verification scale division. – See “verification scale division, value of (e).”[2.20]

E_{\max} (maximum capacity). – Largest value of a quantity (mass) which may be applied to a load cell without exceeding the mpe.[2.20]
(Added 2005)

E_{\min} (minimum dead load). – Smallest value of a quantity (mass) which may be applied to a load cell during test or use without exceeding the mpe.[2.20]
(Added 2006)

e_{\min} (minimum verification scale division). – The smallest scale division for which a weighing element complies with the applicable requirements.[2.20, 2.21, 2.24]

(Added 1997)

electronic link. – An electronic connection between the weighing/load-receiving or other sensing element and indicating element where one recognizes the other and neither can be replaced without calibration.[2.20]

(Added 2001)

element. – A portion of a weighing or measuring device or system which performs a specific function and can be separated, evaluated separately, and is subject to specified full or partial error limits.

(Added 2002)

equal-arm scale. – A scale having only a single lever with equal arms (that is, with a multiple of one), equipped with two similar or dissimilar load-receiving elements (pan, plate, platter, scoop, or the like), one intended to receive material being weighed and the other intended to receive weights. There may or may not be a weighbeam.[2.20]

equipment, commercial. – Weights, measures, and weighing and measuring devices, instruments, elements, and systems or portion thereof, used or employed in establishing the measurement or in computing any basic charge or payment for services rendered on the basis of weight or measure. As used in this definition, measurement includes the determination of size, quantity, value, extent, area, composition (limited to meat and poultry), constituent value (for grain), or measurement of quantities, things, produce, or articles for distribution or consumption, purchased, offered, or submitted for sale, hire, or award.[1.10, 2.20, 2.21, 2.22, 2.24, 3.30, 3.31, 3.32, 3.33, 3.34, 3.35, 3.38, 4.40, 5.51, 5.56(a), 5.56(b), 5.57, 5.58, 5.59]

(Added 2008)

event counter. – A non-resettable counter that increments once each time the mode that permits changes to sealable parameters is entered and one or more changes are made to sealable calibration or configuration parameters of a device.[2.20, 2.21, 3.30, 3.37, 5.54, 5.56(a), 5.56(b), 5.57]

(Added 1993)

event logger. – A form of audit trail containing a series of records where each record contains the number from the event counter corresponding to the change to a sealable parameter, the identification of the parameter that was changed, the time and date when the parameter was changed, and the new value of the parameter.[2.20, 2.21, 3.30, 3.37, 5.54, 5.56(a), 5.56(b), 5.57]

(Added 1993)

excess and deficiency. – When an instrument or device is of such a character that it has a value of its own that can be determined, its error is said to be “in excess” or “in deficiency,” depending upon whether its actual value is, respectively, greater or less than its nominal value. (See Also see “nominal.”) Examples of instruments having errors “in excess” are: a linear measure that is too long; a liquid measure that is too large; and a weight that is “heavy.” Examples of instruments having errors “in deficiency” are: a lubricating-oil bottle that is too small; a vehicle tank compartment that is too small; and a weight that is “light.”[1.10]

extras. – Charges to be paid by a passenger in addition to the fare, including any charge at a flat rate for the transportation of passengers in excess of a stated number and any charge for the transportation of baggage.[5.54]

F

face. – That side of a taximeter on which passenger charges are indicated.[5.54]

face. – That portion of a computing-type pump or dispenser which displays the actual computation of price per unit, delivered quantity, and total sale price. In the case of some electronic displays, this may not be an integral part of the pump or dispenser.[3.30]

(Added 1987)

fare. – That portion of the charge for the hire of a vehicle that is automatically calculated by a taximeter through the operation of the distance and/or time mechanism.[5.54]

farm milk tank. – A unit for measuring milk or other fluid dairy product, comprising a combination of (1) a stationary or portable tank, whether or not equipped with means for cooling its contents, (2) means for reading the level of liquid in the tank, such as a removable gauge rod or a surface gauge, and (3) a chart for converting level-of-liquid readings to volume; or such a unit in which readings are made on a gauge rod or surface gauge directly in terms of volume. Each compartment of a subdivided tank shall, for purposes of this code, be construed to be a “farm milk tank.”[4.43]

feeding mechanism. – The means for depositing material to be weighed on the belt conveyor.[2.21]

fifth wheel. – A commercially-available distance-measuring device which, after calibration, is recommended for use as a field transfer standard for testing the accuracy of taximeters and odometers on rented vehicles.[5.53, 5.54]

fifth-wheel test. – A distance test similar to a road test, except that the distance traveled by the vehicle under test is determined by a mechanism known as a “fifth wheel” that is attached to the vehicle and that independently measures and indicates the distance.[5.53, 5.54]

flag. – A plate at the end of the lever arm or similar part by which the operating condition of a taximeter is controlled and indicated.[5.54]

fractional bar. – A weighbeam bar of relatively small capacity for obtaining indications intermediate between notches or graduations on a main or tare bar.[2.20]

ft³/h. – Cubic feet per hour.[3.33]

G

gasoline gallon equivalent (GGE). – Gasoline gallon equivalent (GGE) means 5.660 pounds of natural gas.[3.37]
(Added 1994)

gasoline liter equivalent (GLE). – Gasoline liter equivalent (GLE) means 0.678 kilograms of natural gas.[3.37]
(Added 1994)

gauge pressure. – The difference between the pressure at the meter and the atmospheric pressure (psi).[3.33]

gauge rod. – A graduated, “dip-stick” type of measuring rod designed to be partially immersed in the liquid and to be read at the point where the liquid surface crosses the rod.[4.42]

gauging. – The process of determining and assigning volumetric values to specific graduations on the gauge or gauge rod that serve as the basis for the tank volume chart.[4.42]

graduated interval. – The distance from the center of one graduation to the center of the next graduation in a series of graduations. – (Also see “value of minimum graduated interval.”)[1.10]

graduation. – A defining line or one of the lines defining the subdivisions of a graduated series. The term includes such special forms as raised or indented or scored reference “lines” and special characters such as dots. (Also see “main graduation” and “subordinate graduation.”)[1.10]

grain class. – Different grains within the same grain type. For example, there are six classes for the grain type “wheat:” Durum Wheat, Hard Red Spring Wheat, Hard Red Winter Wheat, Soft Red Winter Wheat, Hard White Wheat, and Soft White Wheat.[5.56(a), 5.57]

(Added 2007)

grain hopper scale. – One adapted to the weighing of individual loads of varying amounts of grain.[2.20]

grain moisture meter. – Any device indicating either directly or through conversion tables and/or correction tables the moisture content of cereal grains and oil seeds. Also termed “moisture meter.”[5.56(a), 5.56(b)]

grain sample. – That portion of grain or seed taken from a bulk of grain or seed to be bought or sold and used to determine the moisture content of the bulk.[5.56(a), 5.56(b)]

grain-test scale. – A scale adapted to weighing grain samples used in determining moisture content, dockage, weight per unit volume, etc.[2.20]

grain type. – See “kind of grain.”[5.56(a), 5.57]

(Added 2007)

gravity discharge. – A type of device designed for discharge by gravity.[3.30, 3.31]

H

head pulley. – The pulley at the discharge end of the belt conveyor. The power drive to drive the belt is generally applied to the head pulley.[2.21]

hexahedron. – A geometric solid (i.e., box) with six rectangular or square plane surfaces.[5.58]

(Added 2008)

hired. – A taximeter is “hired” when it is operative with respect to all applicable indications of fare or extras. The indications of fare include time and distance where applicable unless qualified by another indication of “Time Not Recording” or an equivalent expression.[5.54]

hopper scale. – A scale designed for weighing bulk commodities whose load-receiving element is a tank, box, or hopper mounted on a weighing element. (Also see “automatic hopper scale,” “grain hopper scale,” and “construction materials hopper scale.”)[2.20]

I

idler space. – The center-to-center distance between idler rollers measured parallel to the belt.[2.21]

idlers or idler rollers. – Freely turning cylinders mounted on a frame to support the conveyor belt. For a flat belt, the idlers consist of one or more horizontal cylinders transverse to the direction of belt travel. For a troughed belt, the idlers consist of one or more horizontal cylinders and one or more cylinders at an angle to the horizontal to lift the sides of the belt to form a trough.[2.21]

in-service light indicator. – A light used to indicate that a timing device is in operation.[5.55]

increasing-load test. – The normal basic performance test for a scale in which observations are made as increments of test load are successively added to the load-receiving element of the scale.[2.20, 2.22]

increment. – The value of the smallest change in value that can be indicated or recorded by a digital device in normal operation.[1.10]

index of an indicator. – The particular portion of an indicator that is directly utilized in making a reading.[1.10]

indicating element. – An element incorporated in a weighing or measuring device by means of which its performance relative to quantity or money value is “read” from the device itself as, for example, an

index-and-graduated-scale combination, a weighbeam-and-poise combination, a digital indicator, and the like. (Also see “primary indicating or recording element.”)[1.10]

indicator, balance. – See “balance indicator.”[2.20]

initial distance or time interval. – The interval corresponding to the initial money drop.[5.54]

initial zero-setting mechanism. – See “initial zero-setting mechanism” under “zero-setting mechanism.”[2.20]
(Added 1990)

integrator. – **A device used with a belt-conveyor scale that combines conveyor belt load (e.g., lb/ft) and belt travel (e.g., feet) to produce a total weight of material passing over the belt-conveyor scale. An integrator may be a separate, detached mechanism or may be a component within a totalizing device. (Also see “master weight totalizer.”)[2.21]**

(Added 2013)

interval, clear, between graduations. – See “clear interval between graduations.”[1.10]

interval, graduated. – See “graduated interval.”[1.10]

irregularly-shaped object. – Any object that is not a hexahedron shape.[5.58]
(Added 2008)

J

jewelers’ scale. – One adapted to weighing gems and precious metals.[2.20]

K

kind of grain. – Corn as distinguished from soybeans as distinguished from wheat, etc.[5.56(a), 5.56(b)]

L

label. – A printed ticket, to be attached to a package, produced by a printer that is a part of a prepackaging scale or that is an auxiliary device.[2.20]

large-delivery device. – Devices used primarily for single deliveries greater than 200 gallons, 2000 pounds, 20 000 cubic feet, 2000 liters, or 2000 kilograms.[3.34, 3.38]

laundry-drier timer. – A timer used in conjunction with a coin-operated device to measure the period of time that a laundry drier is in operation.[5.55]

liquefied petroleum gas. – A petroleum product composed predominantly of any of the following hydrocarbons or mixtures thereof: propane, propylene, butanes (normal butane or isobutane), and butylenes.[3.31, 3.32, 3.33, 3.34, 3.37]

liquefied petroleum gas liquid-measuring device. – A system including a mechanism or machine of the meter type designed to measure and deliver liquefied petroleum gas in the liquid state by a definite quantity, whether installed in a permanent location or mounted on a vehicle. Means may or may not be provided to indicate automatically, for one of a series of unit prices, the total money value of the liquid measured.[3.33]

(Amended 1987)

liquefied petroleum gas vapor-measuring device. – A system including a mechanism or device of the meter type, equipped with a totalizing index, designed to measure and deliver liquefied petroleum gas in the vapor state by

definite volumes, and generally installed in a permanent location. The meters are similar in construction and operation to the conventional natural- and manufactured-gas meters.[3.33]

liquid fuel. – Any liquid used for fuel purposes, that is, as a fuel, including motor-fuel.[3.30, 3.31]

liquid volume correction factor. – A correction factor used to adjust the liquid volume of a cryogenic product at the time of measurement to the liquid volume at NBP.[3.34]

liquid-fuel device. – A device designed for the measurement and delivery of liquid fuels.[3.30]

liquid-measuring device. – A mechanism or machine designed to measure and deliver liquid by definite volume. Means may or may not be provided to indicate automatically, for one of a series of unit prices, the total money value of the liquid measured, or to make deliveries corresponding to specific money values at a definite unit price.[3.30]

livestock scale. – A scale equipped with stock racks and gates and adapted to weighing livestock standing on the scale platform.[2.20]

(Amended 1989)

load cell. – A device, whether electric, hydraulic, or pneumatic, that produces a signal (change in output) proportional to the load applied.[2.20, 2.21, 2.23]

load cell verification interval (v). – The load cell interval, expressed in units of mass, used in the test of the load cell for accuracy classification.[2.20, 2.21]

(Added 1996)

loading point. – ~~The location at which material to be conveyed is applied to the~~ **A location on a conveyor where the material is received by the belt. The location of the discharge from a hopper, chute, or pre-feed device used to supply material to a conveyor.**[2.21]

(Amended 2013)

load-receiving element. – That element of a scale that is designed to receive the load to be weighed; for example, platform, deck, rail, hopper, platter, plate, scoop.[2.20, 2.21, 2.23]

low-flame test. – A test simulating extremely low-flow rates such as caused by pilot lights.[3.33]

lubricant device. – A device designed for the measurement and delivery of liquid lubricants, including, but not limited to, heavy gear lubricants and automatic transmission fluids (automotive).[3.30]

M

m³/h. – Cubic meters per hour.[3.33]

main bar. – A principal weighbeam bar, usually of relatively large capacity as compared with other bars of the same weighbeam. (On an automatic-indicating scale equipped with a weighbeam, the main weighbeam bar is frequently called the “capacity bar.”)[2.20]

main graduation. – A graduation defining the primary or principal subdivisions of a graduated series. (Also see “graduation.”)[1.10]

main-weighbeam elements. – The combination of a main bar and its fractional bar, or a main bar alone if no fractional bar is associated with it.[2.20]

manual zero-setting mechanism. – See “manual zero-setting mechanism” under “zero-setting mechanism.”[2.20]

manufactured device. – Any commercial weighing or measuring device shipped as new from the original equipment manufacturer.[1.10]

(Amended 2001)

mass flow meter. – A device that measures the mass of a product flowing through the system. The mass measurement may be determined directly from the effects of mass on the sensing unit or may be inferred by measuring the properties of the product, such as the volume, density, temperature, or pressure, and displaying the quantity in mass units.[3.37]

master meter test method. – A method of testing milk tanks that utilizes an approved master meter system for measuring test liquid removed from or introduced into the tank.[4.42]

master weight totalizer. – ~~An~~ primary indicating element used with a belt-conveyor scale that incorporates the function of an integrator to indicate the totalized weight of material ~~that was~~ passed over the scale. ~~The master weight totalizer is a primary indicating element of the belt conveyor scale.~~ [(Also see “integrator.”)][2.21]

(Amended 2013)

material test. – The test of a belt-conveyor scale using material (preferably that for which the device is normally used) that has been weighed to an accuracy of 0.1 %.[2.21]

(Amended 1989)

maximum capacity. – The largest load that may be accurately weighed.[2.20, 2.24]

(Added 1999)

maximum cargo load. – The maximum cargo load for trucks is the difference between the manufacturer’s rated gross vehicle weight and the actual weight of the vehicle having no cargo load.[5.53]

measurement field. – A region of space or the measurement pattern produced by the measuring instrument in which objects are placed or passed through, either singly or in groups, when being measured by a single device.[5.58]

measuring element. – That portion of a complete multiple dimension measuring device that does not include the indicating element.[5.58]

meter register. – An observation index for the cumulative reading of the gas flow through the meter. In addition there are one or two proving circles in which one revolution of the test hand represents ½, 1, 2, 5, or 10 cubic feet, or 0.025, 0.05, 0.1, 0.2, or 0.25 cubic meter, depending on meter size. If two proving circles are present, the circle representing the smallest volume per revolution is referred to as the “leak-test circle.”[3.33]

metrological integrity (of a device). – The design, features, operation, installation, or use of a device that facilitates (1) the accuracy and validity of a measurement or transaction, (2) compliance of the device with weights and measures requirements, or (3) the suitability of the device for a given application.[1.10, 2.20]

(Added 1993)

minimum capacity. – The smallest load that may be accurately weighed. The weighing results may be subject to excessive error if used below this value.[2.20, 2.24]

(Added 1999)

minimum clear interval. – The shortest distance between adjacent graduations when the graduations are not parallel. (Also see “clear interval.”)[3.30, 3.31, 3.32, 3.33, 3.34, 3.35, 3.36, 3.38, 5.50, 5.51, 5.56(b)]

minimum delivery. – The least amount of weight that is to be delivered as a single weighment by a belt-conveyor scale system in normal use.[2.21]

minimum tolerance. – Minimum tolerances are the smallest tolerance values that can be applied to a scale. Minimum tolerances are determined on the basis of the value of the minimum graduated interval or the nominal or reading face capacity of the scale. (~~See also~~ **Also see** definition for basic tolerances.)[2.20, 2.22, 2.24]

minimum totalized load. – The least amount of weight for which the scale is considered to be performing accurately.[2.21]

moisture content (wet basis). – The mass of water in a grain or seed sample (determined by the reference method) divided by the mass of the grain or seed sample expressed as a percentage (%).[5.56(a), 5.56(b)]

money drop. – An increment of fare indication. The “initial money drop” is the first increment of fare indication following activation of the taximeter.[5.54]

money-operated type. – A device designed to be released for service by the insertion of money, or to be actuated by the insertion of money to make deliveries of product.[1.10]

motor-fuel. – Liquid used as fuel for internal-combustion engines.[3.30]

motor-fuel device or motor-fuel dispenser or retail motor-fuel device. – A device designed for the measurement and delivery of liquids used as fuel for internal-combustion engines. The term “motor-fuel dispenser” means the same as “motor-fuel device”; the term “retail motor-fuel device” applies to a unique category of device ~~€.~~ **(Also see definition of “retail device”.)**[3.30, 3.32, 3.37]

multi-class. – A description of a grouping of grain classes, from the same grain type, in one calibration. A multi-class grain calibration may include (1) all the classes of a grain type (all-class calibration), or (2) some of the classes of a grain type within the calibration.[5.56(a), 5.57.]

(Added 2007)

multi-interval scale. – A scale having one weighing range which is divided into partial weighing ranges (segments), each with different scale intervals, with each partial weighing range (segment) determined automatically according to the load applied, both on increasing and decreasing loads.[2.20]

(Added 1995)

multi-jet water meter. – A water meter in which the moving element takes the form of a multiblade rotor mounted on a vertical spindle within a cylindrical measuring chamber. The liquid enters the measuring chamber through several tangential orifices around the circumference and leaves the measuring chamber through another set of tangential orifices placed at a different level in the measuring chamber. These meters register by recording the revolutions of a rotor set in motion by the force of flowing water striking the blades.[3.36]

(Added 2003)

multi-revolution scale. – An automatic-indicating scale having a nominal capacity that is a multiple of the reading-face capacity and that is achieved by more than one complete revolution of the indicator.[2.20]

multiple. – An integral multiple; that is, a result obtained by multiplying by a whole number. (Also see “multiple of a scale.”)[1.10]

multiple cell application load cell. – A load cell intended for use in a weighing system which incorporates more than one load cell. A multiple cell application load cell is designated with the letter “M” or the term “Multiple.”

(See also **Also see** “single cell application load cell.”)[2.20]

(Added 1999)

multiple of a scale. – In general, the multiplying power of the entire system of levers or other basic weighing elements. (On a beam scale, the multiple of the scale is the number of pounds on the load-receiving element that will be counterpoised by 1 pound applied to the tip pivot of the weighbeam.)[2.20]

multiple range scale. – A scale having two or more weighing ranges with different maximum capacities and different scale intervals for the same load receptor, each range extending from zero to its maximum capacity.[2.20]

(Added 1995)

multiple-tariff taximeter. – One that may be set to calculate fares at any one of two or more rates.[5.54]

N

natural gas. – A gaseous fuel, composed primarily of methane, that is suitable for compression and dispensing into a fuel storage container(s) for use as an engine fuel.[3.37]

(Added 1994)

NBP. – Normal Boiling Point of a cryogenic liquid at 14.696 lb/in² absolute.[3.34]

n_{max} (maximum number of scale divisions). – The maximum number of scale divisions for which a main element or load cell complies with the applicable requirements. The maximum number of scale divisions permitted for an installation is limited to the lowest n_{max} marked on the scale indicating element, weighing element, or load cell.[2.20, 2.21, 2.24]

(Added 1997)

no-load reference value. – A positive weight value indication with no load in the load-receiving element (hopper) of the scale. (Used with automatic bulk-weighing systems and certain single-draft, manually-operated receiving hopper scales installed below grade and used to receive grain.)[2.20]

nominal. – Refers to “intended” or “named” or “stated,” as opposed to “actual.” For example, the “nominal” value of something is the value that it is supposed or intended to have, the value that it is claimed or stated to have, or the value by which it is commonly known. Thus, “1-pound weight,” “1-gallon measure,” “1-yard indication,” and “500-pound scale” are statements of nominal values; corresponding actual values may be greater or lesser. (See Also see nominal capacity of a scale.)[1.10]

nominal capacity. – The nominal capacity of a scale is (a) the largest weight indication that can be obtained by the use of all of the reading or recording elements in combination, including the amount represented by any removable weights furnished or ordinarily furnished with the scale, but excluding the amount represented by any extra removable weights not ordinarily furnished with the scale, and excluding also the capacity of any auxiliary weighing attachment not contemplated by the original design of the scale, and excluding any fractional bar with a capacity less than 2½ % of the sum of the capacities of the remaining reading elements, or (b) the capacity marked on the scale by the manufacturer, whichever is less. (Also see “nominal capacity, batching scale”; “nominal capacity, hopper scale.”)[2.20]

nominal capacity, batching scale. – The nominal capacity of a batching scale is the capacity as marked on the scale by the scale manufacturer, or the sum of the products of the volume of each of the individual hoppers, in terms of cubic feet, times the weight per cubic foot of the heaviest material weighed in each hopper, whichever is less.[2.20]

nominal capacity, hopper scale. – The nominal capacity of a hopper scale is the capacity as marked on the scale by the scale manufacturer, or the product of the volume of the hopper in bushels or cubic feet times the maximum weight per bushel or cubic foot, as the case may be, of the commodity normally weighed, whichever is less.[2.20]

non-automatic checkweigher. – A weighing instrument that requires the intervention of an operator during the weighing process, used to subdivide items of different weights into one or more subgroups, such as identifying packages that have acceptable or unacceptable fill levels according to the value of the difference between their weight and a pre-determined set point.[2.24]

Notes: Determining the weighing result includes any intelligent action of the operator that affects the result, such as deciding and taking an action when an indication is stable or adjusting the weight of the weighed load.

Deciding the weighing result is acceptable means making a decision regarding the acceptance of each weighing result on observing the indication or releasing a print-out. The weighing process allows the operator to take an action which influences the weighing result in the case where the weighing result is not acceptable.

(Added 2004)

non-automatic weighing instrument. – A weighing instrument or system that requires the intervention of an operator during the weighing process to determine the weighing result or to decide that it is acceptable.[2.20, 2.24]

Notes: Determining the weighing result includes any intelligent action of the operator that affects the result, such as deciding and taking an action when an indication is stable or adjusting the weight of the weighed load.

Deciding the weighing result is acceptable means making a decision regarding the acceptance of each weighing result on observing the indication or releasing a print-out. The weighing process allows the operator to take an action which influences the weighing result in the case where the weighing result is not acceptable.

(Added 2004) (Amended 2005)

nonretroactive. – “Nonretroactive” requirements are enforceable after the effective date for:

1. devices manufactured within a state after the effective date;
2. both new and used devices brought into a state after the effective date; and
3. devices used in noncommercial applications which are placed into commercial use after the effective date.

Nonretroactive requirements are not enforceable with respect to devices that are in commercial service in the state as of the effective date or to new equipment in the stock of a manufacturer or a dealer in the state as of the effective date. (*Nonretroactive requirements are printed in italic type.*)[1.10]

(Amended 1989)

nose-iron. – A slide-mounted, manually-adjustable pivot assembly for changing the multiple of a lever.[2.20]

notes. – A section included in each of a number of codes, containing instructions, pertinent directives, and other specific information pertaining to the testing of devices. Notes are primarily directed to weights and measures officials.

NTP. – Normal Temperature and Pressure of a cryogen at a temperature of 21 °C (70 °F) and a pressure of 101.325 kPa (14.696 lb/in² absolute).[3.34]

NTP density and volume correction factor. – A correction factor used to adjust the liquid volume of a cryogenic product at the time of measurement to the gas equivalent at NTP.[3.34]

O

odometer. – A device that automatically indicates the total distance traveled by a vehicle. For the purpose of this code, this definition includes hub odometers, cable-driven odometers, and the distance-indicating or odometer portions of “speedometer” assemblies for automotive vehicles.[5.53]

official grain samples. – Grain or seed used by the official as the official transfer standard from the reference standard method to test the accuracy and precision of grain moisture meters.[5.56(a), 5.56(b)]

official with statutory authority. – The representative of the jurisdiction(s) responsible for certifying the accuracy of the device.[2.20, 2.21, 2.22]

(Added 1991)

operating tire pressure. – The pressure in a tire immediately after a vehicle has been driven for at least 5 miles or 8 kilometers.[5.53, 5.54]

over-and-under indicator. – An automatic-indicating element incorporated in or attached to a scale and comprising an indicator and a graduated scale with a central or intermediate “zero” graduation and a limited range of weight

graduations on either side of the zero graduation, for indicating weights greater than and less than the predetermined values for which other elements of the scale may be set. (A scale having an over-and-under indicator is classed as an automatic-indicating scale.)[2.20]

overregistration and underregistration. – When an instrument or device is of such a character that it indicates or records values as a result of its operation, its error is said to be in the direction of overregistration or underregistration, depending upon whether the indications are, respectively, greater or less than they should be. Examples of devices having errors of “overregistration” are: a fabric-measuring device that indicates more than the true length of material passed through it; and a liquid-measuring device that indicates more than the true amount of the liquid delivered by the device. Examples of devices having errors of “underregistration” are: a meter that indicates less than the true amount of product that it delivers; and a weighing scale that indicates or records less than the true weight of the applied load.[1.10]

P

parallax. – The apparent displacement, or apparent difference in height or width, of a graduation or other object with respect to a fixed reference, as viewed from different points.[1.10]

parking meter. – A coin-operated device for measuring parking time for vehicles.[5.55]

passenger vehicles. – Vehicles such as automobiles, recreational vehicles, limousines, ambulances, and hearses.[5.53]

performance requirements. – Performance requirements include all tolerance requirements and, in the case of nonautomatic-indicating scales, sensitivity requirements (SR). (SeeAlso see definitions for “tolerance” and “sensitivity requirement.”)[1.10]

point-of-sale system. – An assembly of elements including a weighing or measuring element, an indicating element, and a recording element (and may also be equipped with a “scanner”) used to complete a direct sales transaction.[2.20, 3.30, 3.32, 3.37]

(Added 1986) (Amended 1997)

poise. – A movable weight mounted upon or suspended from a weighbeam bar and used in combination with graduations, and frequently with notches, on the bar to indicate weight values. (A suspended poise is commonly called a “hanging poise.”)[2.20]

postal scale. – A scale (usually a computing scale) designed for use to determine shipping weight or delivery charges for letters or parcels delivered by the U. S. Postal Service or private shipping companies. A weight classifier may be used as a postal scale.[2.20]

(Added 1987)

prepackaging scale. – A computing scale specially designed for putting up packages of random weights in advance of sale.[2.20]

prescription scale. – A scale or balance adapted to weighing the ingredients of medicinal and other formulas prescribed by physicians and others and used or intended to be used in the ordinary trade of pharmacists.[2.20]

pressure type (device). – A type of device designed for operation with the liquid under artificially produced pressure.[3.30, 3.31]

primary indicating or recording elements. – The term “primary” is applied to those principal indicating (visual) elements and recording elements that are designed to, or may, be used by the operator in the normal commercial use of a device. The term “primary” is applied to any element or elements that may be the determining factor in arriving at the sale representation when the device is used commercially. (Examples of primary elements are the visual

indicators for meters or scales not equipped with ticket printers or other recording elements and both the visual indicators and the ticket printers or other recording elements for meters or scales so equipped.) The term “primary” is not applied to such auxiliary elements as, for example, the totalizing register or predetermined-stop mechanism on a meter or the means for producing a running record of successive weighing operations, these elements being supplementary to those that are the determining factors in sales representations of individual deliveries or weights. (See Also see “indicating element” and “recording element.”)[1.10]

prover method. – A method of testing milk tanks that utilizes approved volumetric prover(s) for measuring the test liquid removed from or introduced into the tank.[4.42]

prover oil. – A light oil of low vapor pressure used as a sealing medium in bell provers, cubic-foot bottles, and portable cubic-foot standards.[3.33]

proving indicator. – The test hand or pointer of the proving or leak-test circle on the meter register or index.[3.33, 3.36.]

R

“r” factor. – A computation for determining the suitability of a vehicle scale for weighing vehicles with varying axle configurations. The factor was derived by dividing the weights in FHWA Federal Highway Bridge Gross Weight Table B by 34 000 lbs. (The resultant factors are contained in Table UR.3.2.1.)[2.20]

radio frequency interference (RFI). – Radio frequency interference is a type of electrical disturbance that, when introduced into electronic and electrical circuits, may cause deviations from the normally expected performance.[1.10]

random error(s). – The sample standard deviation of the error (indicated values) for a number of consecutive automatic weighings of a load, or loads, passed over the load receptor, shall be expressed mathematically as:

$$s = \sqrt{\frac{1}{n-1} \sum (x_i - \bar{x})^2} \text{ or } s = \sqrt{\frac{1}{n-1} \left(\sum x_i^2 - \frac{(\sum x_i)^2}{n} \right)}$$

where: $\frac{x}{n}$ = error of a load indication
 = the number of loads

[2.24]

ranges, weight. – See “weight ranges.”[2.20]

rated capacity. – The rate of flow in cubic meters per hour of a hydrocarbon gas vapor-measuring device as recommended by the manufacturer. This rate of flow should cause a pressure drop across the meter not exceeding ½-inch water column.[3.33]

rated scale capacity. – That value representing the weight that can be delivered by the device in one hour.[2.21]

ratio test. – A test to determine the accuracy with which the actual multiple of a scale agrees with its designed multiple. This test is used for scales employing counterpoise weights and is made with standard test weights substituted in all cases for the weights commercially used on the scale. (It is appropriate to use this test for some scales not employing counterpoise weights.)[2.20]

reading face. – That portion of an automatic-indicating weighing or measuring device that gives a visible indication of the quantity weighed or measured. A reading face may include an indicator and a series of graduations or may present values digitally, and may also provide money-value indications.[1.10, 2.20]

(Amended 2005)

reading-face capacity. – The largest value that may be indicated on the reading face, exclusive of the application or addition of any supplemental or accessory elements.[1.10]

recorded representation. – The printed, embossed, or other representation that is recorded as a quantity by a weighing or measuring device.[1.10]

recording element. – An element incorporated in a weighing or measuring device by means of which its performance relative to quantity or money value is permanently recorded on a tape, ticket, card, or the like, in the form of a printed, stamped, punched, or perforated representation.[1.10, 2.21]

recording scale. – One on which the weights of applied loads may be permanently recorded on a tape, ticket, card, or the like in the form of a printed, stamped, punched, or perforated representation.[2.20]

reference weight car. – A railcar that has been statically weighed for temporary use as a mass standard over a short period of time, typically the time required to test one scale.

Note: A test weight car that is representative of the types of cars typically weighed on the scale under test may be used wherever reference weight cars are specified.[2.20]

(Added 1991) (Amended 2012)

remanufactured device. – A device that is disassembled, checked for wear, parts replaced or fixed, reassembled and made to operate like a new device of the same type.[1.10]

(Added 2001)

remanufactured element. – An element that is disassembled, checked for wear, parts replaced or fixed, reassembled and made to operate like a new element of the same type.[1.10]

(Added 2001)

remote configuration capability. – The ability to adjust a weighing or measuring device or change its sealable parameters from or through some other device that is not itself necessary to the operation of the weighing or measuring device or is not a permanent part of that device.[2.20, 2.21, 2.24, 3.30, 3.37, 5.56(a)]

(Added 1993)

repaired device. – A device to which work is performed that brings the device back into proper operating condition.[1.10]

(Added 2001)

repaired element. – An element to which work is performed that brings the element back into proper operating condition.[1.10]

(Added 2001)

retail device. – A measuring device primarily used to measure product for the purpose of sale to the end user.[3.30, 3.32, 3.37]

(Amended 1987 and 2004)

retroactive. – “Retroactive” requirements are enforceable with respect to all equipment. Retroactive requirements are printed herein in upright roman type. (Also see “nonretroactive.”)[1.10]

road test. – A distance test, over a measured course, of a complete taximeter assembly when installed on a vehicle, the mechanism being actuated as a result of vehicle travel.[5.53, 5.54]

rolling circumference. – The rolling circumference is the straight line distance traveled per revolution of the wheel (or wheels) that actuates the taximeter or odometer. If more than one wheel actuates the taximeter or odometer, the rolling circumference is the average distance traveled per revolution of the actuating wheels.[5.53, 5.54]

S

scale. – See specific type of scale.[2.20]

scale area, belt-conveyor. – See belt-conveyor scale systems area.[2.21]

(Added 2001)

scale division, number of (n). – Quotient of the capacity divided by the value of the verification scale division.[2.20]

$$n = \frac{\text{Capacity}}{e}$$

scale division, value of (d). – The value of the scale division, expressed in units of mass, is the smallest subdivision of the scale for analog indication or the difference between two consecutively indicated or printed values for digital indication or printing. (Also see “verification scale division.”)[2.20, 2.22]

scale section. – A part of a vehicle, axle-load, livestock, or railway track scale consisting of two main load supports, usually transverse to the direction in which the load is applied.[2.20]

seal. – See “approval seal,” “security seal.”[1.10]

section capacity. – The section capacity of a scale is the maximum live load that may be divided equally on the load pivots or load cells of a section.[2.20]

(Added 2001)

section test. – A shift test in which the test load is applied over individual sections of the scale. This test is conducted to disclose the weighing performance of individual sections, since scale capacity test loads are not always available and loads weighed are not always distributed evenly over all main load supports.[2.20]

security means. – A method used to prevent access by other than qualified personnel, or to indicate that access has been made to certain parts of a scale that affect the performance of the device.[2.21]

security seal. – A uniquely identifiable physical seal, such as a lead-and-wire seal or other type of locking seal, a pressure-sensitive seal sufficiently permanent to reveal its removal, or similar apparatus attached to a weighing or measuring device for protection against or indication of access to adjustment. (Also see “approval seal.”)[1.10]

(Amended 1994)

selector-type. – A system of indication or recording in which the mechanism selects, by means of a ratchet-and-pawl combination or by other means, one or the other of any two successive values that can be indicated or recorded.[1.10]

semi-automatic zero-setting mechanism. – See “semi-automatic zero-setting mechanism” under “zero-setting mechanism.”[2.20]

sensitivity (of a nonautomatic-indicating scale). – The value of the test load on the load-receiving element of the scale that will produce a specified minimum change in the position of rest of the indicating element or elements of the scale.[2.20]

sensitivity requirement (SR). – A performance requirement for a non automatic-indicating scale; specifically, the minimum change in the position of rest of the indicating element or elements of the scale in response to the increase or decrease, by a specified amount, of the test load on the load-receiving element of the scale.[2.20]

shift test. – A test intended to disclose the weighing performance of a scale under off-center loading.[2.20]

side. – That portion of a pump or dispenser which faces the consumer during the normal delivery of product.[3.30]
(Added 1987)

simulated-road test. – A distance test during which the taximeter or odometer may be actuated by some means other than road travel. The distance traveled is either measured by a properly calibrated roller device or computed from rolling circumference and wheel-turn data.[5.53, 5.54]

simulated test. – A test using artificial means of loading the scale to determine the performance of a belt-conveyor scale.[2.21]

single cell application load cell. – A load cell intended for use in a weighing system which incorporates one or more load cells. A single cell application load cell is designated with the letter “S” or the term “Single.” (See also Also see “multiple cell application load cell”.)[2.20]

(Added 1999)

single-tariff taximeter. – One that calculates fares at a single rate only.[5.54]

skirting. – Stationary side boards or sections of belt conveyor attached to the conveyor support frame or other stationary support to prevent the bulk material from falling off the side of the belt.[2.21]

slow-flow meter. – A retail device designed for the measurement, at very slow rates (less than 40 L (10 gal) per hour), of liquid fuels at individual domestic installations.[3.30]

small-delivery device. – Any device other than a large-delivery device.[3.34, 3.38]

span (structural). The distance between adjoining sections of a scale.[2.20]

(Added 1988)

specification. – A requirement usually dealing with the design, construction, or marking of a weighing or measuring device. Specifications are directed primarily to the manufacturers of devices.[1.10]

static monorail weighing system. – A weighing system in which the load being applied is stationary during the weighing operation.[2.20]

(Added 1999)

strain-load test. – The test of a scale beginning with the scale under load and applying known test weights to determine accuracy over a portion of the weighing range. The scale errors for a strain-load test are the errors observed for the known test loads only. The tolerances to be applied are based on the known test load used for each error that is determined.[2.20, 2.22]

subordinate graduation. – Any graduation other than a main graduation. (Also see “graduation.”)[1.10]

subsequent distance or time intervals. – The intervals corresponding to money drops following the initial money drop.[5.54]

substitution test. – A scale testing process used to quantify the weight of material or objects for use as a known test load.[2.20]

(Added 2003)

substitution test load. – The sum of the combination of field standard test weights and any other applied load used in the conduct of a test using substitution test methods.[2.20]

(Added 2003)

surface gauge. – A combination of (1) a stationary indicator, and (2) a movable, graduated element designed to be brought into contact with the surface of the liquid from above.[4.42]

systematic (average) error (\bar{x}) . – The mean value of the error (of indication) for a number of consecutive automatic weighings of a load, or loads, passed over the load-receiving element (e.g., weigh-table), shall be expressed mathematically as:

$$\bar{x} = \frac{\sum x}{n}$$

where: x = error of a load indication
 n = the number of loads

[2.24]

T

tail pulley. – The pulley at the opposite end of the conveyor from the head pulley.[2.21]

take-up. – A device to provide sufficient tension in a conveyor belt so that the belt will be positively driven by the drive pulley. – A counter-weighted take-up consists of a pulley free to move in either the vertical or horizontal direction with dead weights applied to the pulley shaft to provide the tension required.[2.21]

tare mechanism. – A mechanism (including a tare bar) designed for determining or balancing out the weight of packaging material, containers, vehicles, or other materials that are not intended to be included in net weight determinations.[2.20]

tare-weighbeam elements. – The combination of a tare bar and its fractional bar, or a tare bar alone if no fractional bar is associated with it.[2.20]

taximeter. – A device that automatically calculates, at a predetermined rate or rates, and indicates the charge for hire of a vehicle.[5.54]

test chain. – A device used for simulated tests consisting of a series of rollers or wheels linked together in such a manner as to assure uniformity of weight and freedom of motion to reduce wear, with consequent loss of weight, to a minimum.[2.21]

test liquid. – The liquid used during the test of a device.[3.30, 3.31, 3.34, 3.35, 3.36, 3.37, 3.38]

test object. – An object whose dimensions are verified by appropriate reference standards and intended to verify compliance of the device under test with certain metrological requirements.[5.58]

test puck. – A metal, plastic, or other suitable object that remains stable for the duration of the test, used as a test load to simulate a package. Pucks can be made in a variety of dimensions and have different weights to represent a wide range of package sizes. Metal versions may be covered with rubber cushions to eliminate the possibility of damage to weighing and handling equipment. The puck mass is adjusted to an accuracy specified in N.1.2. Accuracy of Test Pucks or Packages.[2.24]

(Amended 2004)

test train. – A train consisting of or including reference weight cars and used to test coupled-in-motion railway track scales. The reference weight cars may be placed consecutively or distributed in different places within a train.[2.20]

(Added 1990) (Amended 1991)

test weight car. – A railroad car designed to be a stable mass standard to test railway track scales. The test weight car may be one of the following types: a self-contained composite car, a self-propelled car, or a standard rail car.[2.20]

(Added 1991)

testing. – An operation consisting of a series of volumetric determinations made to verify the accuracy of the volume chart that was developed by gauging.[4.42]

time recorder. – A clock-operated mechanism designed to record the time of day. Examples of time recorders are those used in parking garages to record the “in” and “out” time of day for parked vehicles.[5.55]

timing device. – A device used to measure the time during which a particular paid-for service is dispensed. Examples of timing devices are laundry driers, car-wash timers, parking meters, and parking-garage clocks and recorders.[5.55]

tolerance. – A value fixing the limit of allowable error or departure from true performance or value. (~~See also~~ **Also see** “basic tolerances.”)[1.10]

training idlers. – Idlers of special design or mounting intended to shift the belt sideways on the conveyor to assure the belt is centered on the conveying idlers.[2.21]

transfer standard. – A measurement system designed for use in proving and testing cryogenic liquid-measuring devices.[3.38]

tripper. – A device for unloading a belt conveyor at a point between the loading point and the head pulley.[2.21]

U

uncoupled-in-motion railroad weighing system. – A device and related installation characteristics consisting of (1) the associated approach trackage, (2) the scale (i.e., the weighing element, the load-receiving element, and the indicating element with its software), and (3) the exit trackage, which permit the weighing of railroad cars uncoupled in motion.[2.20]

(Added 1993)

underregistration. – See “overregistration” and “underregistration.”[1.10]

unit price. – The price at which the product is being sold and expressed in whole units of measurement.[1.10, 3.30]
(Added 1992)

unit train. – A unit train is defined as a number of contiguous cars carrying a single commodity from one consignor to one consignee. The number of cars is determined by agreement among the consignor, consignee, and the operating railroad.[2.20]

unit weight. – One contained within the housing of an automatic-indicating scale and mechanically applied to and removed from the mechanism. The application of a unit weight will increase the range of automatic indication, normally in increments equal to the reading-face capacity.[2.20]

user requirement. – A requirement dealing with the selection, installation, use, or maintenance of a weighing or measuring device. User requirements are directed primarily to the users of devices. (~~Also see also~~ **Also see** Introduction, Section Q).[1.10]

usual and customary. – Commonly or ordinarily found in practice or in the normal course of events and in accordance with established practices.[1.10]

utility-type water meter. – 1) A device used for the measurement of water, generally applicable to meters installed in residences or business establishments, excluding batching meters. [3.36]

(Added 2011)

V

value of minimum graduated interval. – 1) The value represented by the interval from the center of one graduation to the center of the succeeding graduation. ~~Also, the~~ 2) The increment between successive recorded values. (Also see “graduated interval.”)[1.10]

vapor equalization credit. – The quantity deducted from the metered quantity of liquid carbon dioxide when a vapor equalizing line is used to facilitate the transfer of liquid during a metered delivery.[3.38]

vapor equalization line. – A hose or pipe connected from the vapor space of the seller’s tank to the vapor space of the buyer’s tank that is used to equalize the pressure during a delivery.[3.38]

vehicle on-board weighing system. – A weighing system designed as an integral part of or attached to the frame, chassis, lifting mechanism, or bed of a vehicle, trailer, industrial truck, industrial tractor, or forklift truck.[2.20]

(Amended 1993)

vehicle scale. – A scale adapted to weighing highway, farm, or other large industrial vehicles (except railroad freight cars), loaded or unloaded.[2.20]

verification scale division, value of (e). – A value, expressed in units of weight (mass) and specified by the manufacturer of a device, by which the tolerance values and the accuracy class applicable to the device are determined. The verification scale division is applied to all scales, in particular to ungraduated devices since they have no graduations. The verification scale division (e) may be different from the displayed scale division (d) for certain other devices used for weight classifying or weighing in pre-determined amounts, and certain other Class I and II scales.[2.20]

visible type. – A type of device in which the measurement takes place in a see-through glass measuring chamber.[3.30]

v_{\min} (minimum load cell verification interval). – The smallest load cell verification interval, *expressed in units of mass** into which the load cell measuring range can be divided.[2.20, 2.24]

[*Nonretroactive as of January 1, 2001]

(Added 1996) (Amended 1999)

W

weighbeam. – An element comprising one or more bars, equipped with movable poises or means for applying counterpoise weights or both.[2.20]

weighing element. – That portion of a scale that supports the load-receiving element and transmits to the indicating element a signal or force resulting from the load applied to the load-receiving element.[2.20, 2.21, 2.22]

(Added 1988)

weigh-labeler. – An automatic weighing system that determines the weight of a package and prints a label or other document bearing a weight declaration for each discrete item (usually a label also includes unit and total price declarations). Weigh-labelers are sometimes used to weigh and label standard and random packages (also called “Prepackaging Scales”).[2.24]

(Amended 2004)

weigh module – **The portion of a load-receiving element supported by two sections. The length of a module is the distance to which load can be applied.**[2.20]

(Added 2013)

weighment. – A single complete weighing operation.[2.20, 2.21]

(Added 1986)

weight, unit. – See “unit weight.”[2.20]

weight classifier. – A digital scale that rounds weight values up to the next scale division. These scales usually have a verification scale division (e) that is smaller than the displayed scale division.[2.20]

(Added 1987)

weight ranges. – Electrical or electro-mechanical elements incorporated in an automatic indicating scale through the application of which the range of automatic indication of the scale is increased, normally in increments equal to the reading-face capacity.[2.20]

wet basis. – See “moisture content (wet basis).”[5.56(a), 5.56(b)]

wet hose. – A discharge hose intended to be full of product at all times. (**See Also see** “wet-hose type.”)[3.30, 3.31, 3.38]

(Amended 2002)

wet-hose type. – A type of device designed to be operated with the discharge hose full of product at all times. (**See Also see** “wet hose.”)[3.30, 3.32, 3.34, 3.37, 3.38]

(Amended 2002)

~~wheel loadweighers.~~ load weighers. – Compact, self-contained, portable weighing elements specially adapted to determining the wheel loads or axle loads of vehicles on highways for the enforcement of highway weight laws only.[2.20]

wholesale device. – Any device other than a retail device. (**See Also see** “retail device.”)[3.30, 3.32]

wing pulley. – A pulley made of widely spaced metal bars in order to set up a vibration to shake loose material off the underside (return side) of the belt.[2.21]

Z

zero-load balance. – A correct weight indication or representation of zero when there is no load on the load-receiving element. (**See also Also see** “zero-load balance for an automatic-indicating scale,” “zero-load balance for a nonautomatic-indicating scale,” “zero-load balance for a recording scale.”)[2.20]

zero-load balance, automatic-indicating scale. – A condition in which the indicator is at rest at, or oscillates through approximately equal arcs on either side of, the zero graduation.[2.20]

zero-load balance, nonautomatic-indicating scale. – A condition in which (a) the weighbeam is at rest at, or oscillates through approximately equal arcs above and below, the center of a trig loop; (b) the weighbeam or lever system is at rest at, or oscillates through approximately equal arcs above and below, a horizontal position or a position midway between limiting stops; or (c) the indicator of a balance indicator is at rest at, or oscillates through approximately equal arcs on either side of, the zero graduation.[2.20]

zero-load balance for a recording scale. – A condition in which the scale will record a representation of zero load.[2.20]

zero-load reference (belt-conveyor scales). – A zero-load reference value represents no load on a moving conveyor belt. This value can be either; a number representing the electronic load cell output, a percentage of full scale capacity, or other reference value that accurately represents the no load condition of a moving conveyor belt. The no load reference value can only be updated after the completion of a zero load test.[2.21]

(Added 2002)

zero-setting mechanism. – Means provided to attain a zero balance indication with no load on the load-receiving element. The types of zero-setting mechanisms are:[2.20, 2.22, 2.24]

automatic zero-setting mechanism (AZSM). – Automatic means provided to set the zero-balance indication without the intervention of an operator.[2.22]

(Added 2010)

automatic zero-tracking (AZT) mechanism. – See “automatic zero-tracking (AZT) mechanism.” (NOTE: AZT maintains zero with specified limits. “Zero-setting sets/establishes zero with limits based on scale capacity.)[2.20, 2.22, 2.24]

initial zero-setting mechanism. – Automatic means provided to set the indication to zero at the time the instrument is switched on and before it is ready for use.[2.20]

(Added 1990)

manual zero-setting mechanism. – Nonautomatic means provided to attain a zero balance indication by the direct operation of a control.[2.20]

semiautomatic zero-setting mechanism. – Automatic means provided to attain a direct zero balance indication requiring a single initiation by an operator.[2.20]

(Amended 2010)

zero-setting mechanism (belt-conveyor scale). – A mechanism enabling zero totalization to be obtained over a whole number of belt revolutions.[2.21, 2.23]

(Added 2002)

zero-tracking mechanism. – See “automatic zero-tracking mechanism” under “zero-setting mechanism.”[2.20, 2.22, 2.24]

zone of uncertainty. – The zone between adjacent increments on a digital device in which the value of either of the adjacent increments may be displayed.[2.20]

Section 1.10. General Code

G-A. Application

G-A.1. Commercial and Law-Enforcement Equipment. – These specifications, tolerances, and other technical requirements apply as follows:

- (a) To commercial weighing and measuring equipment; that is, to weights and measures and weighing and measuring devices commercially used or employed in establishing the size, quantity, extent, area, composition (limited to meat and poultry), constituent values (limited to grain), or measurement of quantities, things, produce, or articles for distribution or consumption, purchased, offered, or submitted for sale, hire, or award, or in computing any basic charge or payment for services rendered on the basis of weight or measure.

(Amended 2008)

- (b) To any accessory attached to or used in connection with a commercial weighing or measuring device when such accessory is so designed that its operation affects the accuracy of the device.
- (c) To weighing and measuring equipment in official use for the enforcement of law or for the collection of statistical information by government agencies.

(These requirements should be used as a guide by the weights and measures official when, upon request, courtesy examinations of noncommercial equipment are made.)

G-A.2. Code Application. – This General Code shall apply to all classes of devices as covered in the specific codes. The specific code requirements supersede General Code requirements in all cases of conflict.

(Amended 1972)

G-A.3. Special and Unclassified Equipment. – Insofar as they are clearly appropriate, the requirements and provisions of the General Code and of specific codes apply to equipment failing, by reason of special design or otherwise, to fall clearly within one of the particular equipment classes for which separate codes have been established. With respect to such equipment, code requirements and provisions shall be applied with due regard to the design, intended purpose, and conditions of use of the equipment.

G-A.4. Metric Equipment. – Employment of the weights and measures of the metric system is lawful throughout the United States. These specifications, tolerances, and other requirements shall not be understood or construed as in any way prohibiting the manufacture, sale, or use of equipment designed to give results in terms of metric units. The specific provisions of these requirements and the principles upon which the requirements are based shall be applied to metric equipment insofar as appropriate and practicable. The tolerances on metric equipment, when not specified herein, shall be equivalent to those specified for similar equipment constructed or graduated in the inch-pound system.

G-A.5. Retroactive Requirements. – “Retroactive” requirements are enforceable with respect to all equipment. Retroactive requirements are printed herein in upright roman type.

G-A.6. Nonretroactive Requirements. – “Nonretroactive” requirements are enforceable on or after the effective date for devices:

- (a) manufactured within a state after the effective date;
- (b) both new and used, brought into a state after the effective date;
- (c) used in noncommercial applications which are placed into commercial use after the effective date; and

- (d) undergoing type evaluation, including devices that have been modified to the extent that a new NTEP Certificate of Conformance (CC) is required.

Nonretroactive requirements are not enforceable with respect to devices that are in commercial service in the state as of the effective date or to new equipment in the stock of a manufacturer or a dealer in the state as of the effective date.

[Nonretroactive requirements are printed in italic type.]

(Amended 1989 and 2011)

G-A.7. Effective Enforcement Dates of Code Requirements. – Unless otherwise specified, each new or amended code requirement shall not be subject to enforcement prior to January 1 of the year following the adoption by the National Conference on Weights and Measures and publication by the National Institute of Standards and Technology.

G-S. Specifications

G-S.1. Identification. – All equipment, except weights and separate parts necessary to the measurement process but not having any metrological effect, shall be clearly and permanently marked for the purposes of identification with the following information:

- (a) the name, initials, or trademark of the manufacturer or distributor;
- (b) a model identifier that positively identifies the pattern or design of the device;

(1) The model identifier shall be prefaced by the word “Model,” “Type,” or “Pattern.” These terms may be followed by the word “Number” or an abbreviation of that word. The abbreviation for the word “Number” shall, as a minimum, begin with the letter “N” (e.g., No or No.). The abbreviation for the word “Model” shall be “Mod” or “Mod.” Prefix lettering may be initial capitals, all capitals, or all lower case.

[Nonretroactive as of January 1, 2003]

(Added 2000) (Amended 2001)

- (c) *a nonrepetitive serial number, except for equipment with no moving or electronic component parts and not-built-for-purpose, software-based devices;*

[Nonretroactive as of January 1, 1968]

(Amended 2003)

(1) The serial number shall be prefaced by words, an abbreviation, or a symbol, that clearly identifies the number as the required serial number.

[Nonretroactive as of January 1, 1986]

(2) Abbreviations for the word “Serial” shall, as a minimum, begin with the letter “S,” and abbreviations for the word “Number” shall, as a minimum, begin with the letter “N” (e.g., S/N, SN, Ser. No., and S. No.).

[Nonretroactive as of January 1, 2001]

- (d) *the current software version or revision identifier for not-built-for-purpose, software-based devices;*

[Nonretroactive as of January 1, 2004]

(Added 2003)

(1) The version or revision identifier shall be prefaced by words, an abbreviation, or a symbol, that clearly identifies the number as the required version or revision.

[Nonretroactive as of January 1, 2007]

(Added 2006)

- (2) *Abbreviations for the word “Version” shall, as a minimum, begin with the letter “V” and may be followed by the word “Number.” Abbreviations for the word “Revision” shall, as a minimum, begin with the letter “R” and may be followed by the word “Number.” The abbreviation for the word “Number” shall, as a minimum, begin with the letter “N” (e.g., No or No.).*

[Nonretroactive as of January 1, 2007]

(Added 2006)

- (e) *an National Type Evaluation Program (NTEP) Certificate of Conformance (CC) number or a corresponding CC Addendum Number for devices that have a CC. The CC Number or a corresponding CC Addendum Number shall be prefaced by the terms “NTEP CC,” “CC,” or “Approval.” These terms may be followed by the word “Number” or an abbreviation of that word. The abbreviation for the word “Number” shall, as a minimum, begin with the letter “N” (e.g., No or No.).*

[Nonretroactive as of January 1, 2003]

The required information shall be so located that it is readily observable without the necessity of the disassembly of a part requiring the use of any means separate from the device.

(Amended 1985, 1991, 1999, 2000, 2001, 2003, and 2006)

G-S.1.1. Location of Marking Information for Not-Built-For-Purpose, Software-Based Devices. – *For not-built-for-purpose, software-based devices either:*

- (a) *The required information in G-S.1 Identification. (a), (b), (d), and (e) shall be permanently marked or continuously displayed on the device; or*

- (b) *The Certificate of Conformance (CC) Number shall be:*

(1) *permanently marked on the device;*

(2) *continuously displayed; or*

(3) *accessible through an easily recognized menu and, if necessary, a submenu. Examples of menu and submenu identification include, but are not limited to, “Help,” “System Identification,” “G-S.1. Identification,” or “Weights and Measures Identification.”*

Note: *For (b), clear instructions for accessing the information required in G-S.1. (a), (b), and (d) shall be listed on the CC, including information necessary to identify that the software in the device is the same type that was evaluated.*

[Nonretroactive as of January 1, 2004]

(Added 2003) (Amended 2006)

G-S.1.2. Devices and Main Elements Remanufactured as of January 1, 2002. – *All devices and main elements remanufactured as of January 1, 2002, shall be clearly and permanently marked for the purposes of identification with the following information ~~the~~:*

- (a) *the name, initials, or trademark of the last remanufacturer or distributor; and*

- (b) *the remanufacturer’s or distributor’s model designation, if different than the original model designation.*

(Added 2001) (Amended 2011)

Note: Definitions for “manufactured device,” “repaired device,” and “repaired element” are included (along with definitions for “remanufactured device” and “remanufactured element”) in Appendix D, Definitions.

G-S.2. Facilitation of Fraud. – All equipment and all mechanisms, software, and devices attached to or used in conjunction therewith shall be so designed, constructed, assembled, and installed for use such that they do not facilitate the perpetration of fraud.

(Amended 2007)

G-S.3. Permanence. – All equipment shall be of such materials, design, and construction as to make it probable that, under normal service conditions:

- (a) accuracy will be maintained;
- (b) operating parts will continue to function as intended; and
- (c) adjustments will remain reasonably permanent.

Undue stresses, deflections, or distortions of parts shall not occur to the extent that accuracy or permanence is detrimentally affected.

G-S.4. Interchange or Reversal of Parts. – Parts of a device that may readily be interchanged or reversed in the course of field assembly or of normal usage shall be:

- (a) so constructed that their interchange or reversal will not affect the performance of the device; or
- (b) so marked as to show their proper positions.

G-S.5. Indicating and Recording Elements.

G-S.5.1. General. – All weighing and measuring devices shall be provided with indicating or recording elements appropriate in design and adequate in amount. Primary indications and recorded representations shall be clear, definite, accurate, and easily read under any conditions of normal operation of the device.

G-S.5.2. Graduations, Indications, and Recorded Representations.

G-S.5.2.1. Analog Indication and Representation. – Graduations and a suitable indicator shall be provided in connection with indications designed to advance continuously.

G-S.5.2.2. Digital Indication and Representation. – Digital elements shall be so designed that:

- (a) All digital values of like value in a system agree with one another.
- (b) A digital value coincides with its associated analog value to the nearest minimum graduation.
- (c) A digital value “rounds off” to the nearest minimum unit that can be indicated or recorded.
- (d) *A digital zero indication includes the display of a zero for all places that are displayed to the right of the decimal point and at least one place to the left. When no decimal values are displayed, a zero shall be displayed for each place of the displayed scale division.*

[Nonretroactive as of January 1, 1986]

(Amended 1973 and 1985)

G-S.5.2.3. Size and Character. – In any series of graduations, indications, or recorded representations, corresponding graduations and units shall be uniform in size and character. Graduations, indications, or recorded representations that are subordinate to, or of a lesser value than others with which they are associated, shall be appropriately portrayed or designated.

[Made retroactive as of January 1, 1975]

G-S.5.2.4. Values. – If graduations, indications, or recorded representations are intended to have specific values, these shall be adequately defined by a sufficient number of figures, words, symbols, or combinations thereof, uniformly placed with reference to the graduations, indications, or recorded representations and as close thereto as practicable, but not so positioned as to interfere with the accuracy of reading.

G-S.5.2.5. Permanence. – Graduations, indications, or recorded representations and their defining figures, words, and symbols shall be of such character that they will not tend easily to become obliterated or illegible.

G-S.5.3. Values of Graduated Intervals or Increments. – In any series of graduations, indications, or recorded representations, the values of the graduated intervals or increments shall be uniform throughout the series.

G-S.5.3.1. On Devices That Indicate or Record in More Than One Unit. – On devices designed to indicate or record in more than one unit of measurement, the values indicated and recorded shall be identified with an appropriate word, symbol, or abbreviation.

(Amended 1978 and 1986)

G-S.5.4. Repeatability of Indications. – A device shall be capable of repeating, within prescribed tolerances, its indications and recorded representations. This requirement shall be met irrespective of repeated manipulation of any element of the device in a manner approximating normal usage (including displacement of the indicating elements to the full extent allowed by the construction of the device and repeated operation of a locking or relieving mechanism) and of the repeated performance of steps or operations that are embraced in the testing procedure.

G-S.5.5. Money Values, Mathematical Agreement. – Any recorded money value and any digital money-value indication on a computing-type weighing or measuring device used in retail trade shall be in mathematical agreement with its associated quantity representation or indication to the nearest 1 cent of money value. This does not apply to auxiliary digital indications intended for the operator's use only, when these indications are obtained from existing analog customer indications that meet this requirement.

(Amended 1973)

G-S.5.6. Recorded Representations. – Insofar as they are appropriate, the requirements for indicating and recording elements shall also apply to recorded representations. All recorded values shall be printed digitally.

(Amended 1975)

G-S.5.6.1. Indicated and Recorded Representation of Units. – Appropriate abbreviations.

- (a) For equipment manufactured on or after January 1, 2008, the appropriate defining symbols are shown in NIST Special Publication SP 811 "Guide for the Use of International System of Units (SI)" and Handbook 44 Appendix C – General Tables of Units of Measurement.

Note: SP 811 can be viewed or downloaded at <http://physics.nist.gov/cuu/pdf/sp811.pdf> or by going to <http://www.nist.gov/pml/wmd/index.cfm> and selecting Weights and Measures Publications and the link to Special Publications, Guide for the Use of the International System of Units (SI) (SP 811).

(Added 2007)

- (b) The appropriate defining symbols on equipment manufactured prior to January 1, 2008, with limited character sets are shown in Table 1. Representation of SI Units on Equipment Manufactured Prior to January 1, 2008, with Limited Character Sets.

(Added 1977) (Amended 2007)

| Table 1. Representation of SI Units on Equipment Manufactured Prior to January 1, 2008, with Limited Character Sets | | | | |
|--|---|-----------------------|----------------------------|----------------------------|
| Name of Unit | International Symbol (common use symbol) | Representation | | |
| | | Form I | Form II | |
| | | (double case) | (single case lower) | (single case upper) |
| Base SI Units | | | | |
| meter | m | m | m | M |
| kilogram | kg | kg | kg | KG |
| Derived SI Units | | | | |
| newton | N | N | n | N |
| pascal | Pa | Pa | pa | PA |
| watt | W | W | w | W |
| volt | V | V | v | V |
| degree Celsius | °C | °C | °c | °C |
| Other Units | | | | |
| liter | l or L | L | l | L |
| gram | g | g | g | G |
| metric ton | t | t | tne | TNE |
| bar | bar | bar | bar | BAR |

(Table Amended 2007)

G-S.5.7. Magnified Graduations and Indications. – All requirements for graduations and indications apply to a series of graduations and an indicator magnified by an optical system or as magnified and projected on a screen.

G-S.6. Marking Operational Controls, Indications, and Features. – All operational controls, indications, and features, including switches, lights, displays, push buttons, and other means, shall be clearly and definitely identified. The use of approved pictograms or symbols shall be acceptable.

[Nonretroactive as of January 1, 1977]

(Amended 1978 and 1995)

G-S.7. Lettering. – All required markings and instructions shall be distinct and easily readable and shall be of such character that they will not tend to become obliterated or illegible.

G-S.8. Provision for Sealing Electronic Adjustable Components. – A device shall be designed with provision(s) for applying a security seal that must be broken, or for using other approved means of providing security (e.g., data change audit trail available at the time of inspection), before any change that detrimentally affects the metrological integrity of the device can be made to any electronic mechanism.

[Nonretroactive as of January 1, 1990]

A device may be fitted with an automatic or a semi-automatic calibration mechanism. This mechanism shall be incorporated inside the device. After sealing, neither the mechanism nor the calibration process shall facilitate fraud.

(Added 1985) (Amended 1989 and 1993)

G-S.8.1. Multiple Weighing or Measuring Elements that Share a Common Provision for Sealing. – A change to any metrological parameter (calibration or configuration) of any weighing or measuring element shall be individually identified.

[Nonretroactive as of January 1, 2010]

Note: For devices that utilize an electronic form of sealing, in addition to the requirements in G-S.8.1., any appropriate audit trail requirements in an applicable specific device code also apply. Examples of identification of a change to the metrological parameters of a weighing or measuring element include, but are not limited to:

- (1) a broken, missing, or replaced physical seal on an individual weighing, measuring, or indicating element or active junction box;
 - (2) a change in a calibration factor or configuration setting for each weighing or measuring element;
 - (3) a display of the date of calibration or configuration event for each weighing or measuring element; or
 - (4) counters indicating the number of calibration and/or configuration events for each weighing or measuring element.
- (Added 2007)

G-N. Notes

G-N.1. Conflict of Laws and Regulations. – If any particular provisions of these specifications, tolerances, and other requirements are found to conflict with existing state laws, or with existing regulations or local ordinances relating to health, safety, or fire prevention, the enforcement of such provisions shall be suspended until conflicting requirements can be harmonized. Such suspension shall not affect the validity or enforcement of the remaining provisions of these specifications, tolerances, and other requirements.

G-N.2. Testing With Nonassociated Equipment. – Tests to determine conditions, such as radio frequency interference (RFI) that may adversely affect the performance of a device shall be conducted with equipment and under conditions that are usual and customary with respect to the location and use of the device.
(Added 1976)

G-T. Tolerances

G-T.1. Acceptance Tolerances. – Acceptance tolerances shall apply to equipment:

- (a) to be put into commercial use for the first time;
 - (b) that has been placed in commercial service within the preceding 30 days and is being officially tested for the first time;
 - (c) that has been returned to commercial service following official rejection for failure to conform to performance requirements and is being officially tested for the first time within 30 days after corrective service;
 - (d) that is being officially tested for the first time within 30 days after major reconditioning or overhaul; and
 - (e) undergoing type evaluation.
- (Amended 1989)

G-T.2. Maintenance Tolerances. – Maintenance tolerances shall apply to equipment in actual use, except as provided in G-T.1. Acceptance Tolerances.

G-T.3. Application. – Tolerances “in excess” and tolerances “in deficiency” shall apply to errors in excess and to errors in deficiency, respectively. Tolerances “on overregistration” and tolerances “on underregistration” shall apply to errors in the direction of overregistration and of underregistration, respectively. (See Also see Appendix D, Definitions.)

G-T.4. For Intermediate Values. – For a capacity, indication, load, value, etc., intermediate between two capacities, indications, loads, values, etc., listed in a table of tolerances, the tolerances prescribed for the lower capacity, indication, load, value, etc., shall be applied.

G-UR. User Requirements

G-UR.1. Selection Requirements.

G-UR.1.1. Suitability of Equipment. – Commercial equipment shall be suitable for the service in which it is used with respect to elements of its design, including but not limited to its weighing capacity (for weighing devices), its computing capability (for computing devices), its rate of flow (for liquid-measuring devices), the character, number, size, and location of its indicating or recording elements, and the value of its smallest unit and unit prices.

(Amended 1974)

G-UR.1.2. Environment. – Equipment shall be suitable for the environment in which it is used including, but not limited to, the effects of wind, weather, and RFI.

(Added 1976)

G-UR.1.3. Liquid-Measuring Devices. – To be suitable for its application, the minimum delivery for liquid-measuring devices shall be no less than 100 divisions, except that the minimum delivery for retail analog devices shall be no less than 10 divisions. Maximum division values and tolerances are stated in the specific codes.

(Added 1995)

G-UR.2. Installation Requirements.

G-UR.2.1. Installation. – A device shall be installed in accordance with the manufacturer's instructions, including any instructions marked on the device. A device installed in a fixed location shall be installed so that neither its operation nor its performance will be adversely affected by any characteristic of the foundation, supports, or any other detail of the installation.

G-UR.2.1.1. Visibility of Identification. – Equipment shall be installed in such a manner that all required markings are readily observable.

(Added 1978)

G-UR.2.2. Installation of Indicating or Recording Element. – A device shall be so installed that there is no obstruction between a primary indicating or recording element and the weighing or measuring element; otherwise there shall be convenient and permanently installed means for direct communication, oral or visual, between an individual located at a primary indicating or recording element and an individual located at the weighing or measuring element. [~~See also~~ **Also see** G-UR.3.3. Position of Equipment.]

G-UR.2.3. Accessibility for Inspection, Testing, and Sealing Purposes. – A device shall be located, or such facilities for normal access thereto shall be provided, to permit:

- (a) inspecting and testing the device;
- (b) inspecting and applying security seals to the device; and
- (c) readily bringing the testing equipment of the weights and measures official to the device by customary means and in the amount and size deemed necessary by such official for the proper conduct of the test.

Otherwise, it shall be the responsibility of the device owner or operator to supply such special facilities, including such labor as may be needed to inspect, test, and seal the device, and to transport the testing equipment to and from the device, as required by the weights and measures official.

(Amended 1991)

G-UR.3. Use Requirements.

G-UR.3.1. Method of Operation. – Equipment shall be operated only in the manner that is obviously indicated by its construction or that is indicated by instructions on the equipment.

G-UR.3.2. Associated and Nonassociated Equipment. – A device shall meet all performance requirements when associated or nonassociated equipment is operated in its usual and customary manner and location.

(Added 1976)

G-UR.3.3. Position of Equipment. – A device or system equipped with a primary indicating element and used in direct sales, except for prescription scales, shall be positioned so that its indications may be accurately read and the weighing or measuring operation may be observed from some reasonable “customer” and “operator” position. The permissible distance between the equipment and a reasonable customer and operator position shall be determined in each case upon the basis of the individual circumstances, particularly the size and character of the indicating element.

(Amended 1974 and 1998)

G-UR.3.4. Responsibility, Money-Operated Devices. – Money-operated devices, other than parking meters, shall have clearly and conspicuously displayed thereon, or immediately adjacent thereto, adequate information detailing the method for the return of monies paid when the product or service cannot be obtained. This information shall include the name, address, and phone number of the local responsible party for the device. This requirement does not apply to devices at locations where employees are present and responsible for resolving any monetary discrepancies for the customer.

(Amended 1977 and 1993)

G-UR.4. Maintenance Requirements.

G-UR.4.1. Maintenance of Equipment. – All equipment in service and all mechanisms and devices attached thereto or used in connection therewith shall be continuously maintained in proper operating condition throughout the period of such service. Equipment in service at a single place of business found to be in error predominantly in a direction favorable to the device user (Also see ~~also~~ the Introduction, Section Q) shall not be considered “maintained in a proper operating condition.”

(Amended 1973 and 1991)

G-UR.4.2. Abnormal Performance. – Unstable indications or other abnormal equipment performance observed during operation shall be corrected and, if necessary, brought to the attention of competent service personnel.

(Added 1976)

G-UR.4.3. Use of Adjustments. – Weighing elements and measuring elements that are adjustable shall be adjusted only to correct those conditions that such elements are designed to control, and shall not be adjusted to compensate for defective or abnormal installation or accessories or for badly worn or otherwise defective parts of the assembly. Any faulty installation conditions shall be corrected, and any defective parts shall be renewed or suitably repaired, before adjustments are undertaken. Whenever equipment is adjusted, the adjustments shall be so made as to bring performance errors as close as practicable to zero value.

G-UR.4.4. Assistance in Testing Operations. – If the design, construction, or location of any device is such as to require a testing procedure involving special equipment or accessories or an abnormal amount of labor,

such equipment, accessories, and labor shall be supplied by the owner or operator of the device as required by the weights and measures official.

G-UR.4.5. Security Seal. – A security seal shall be appropriately affixed to any adjustment mechanism designed to be sealed.

G-UR.4.6. Testing Devices at a Central Location.

- (a) When devices in commercial service require special test facilities, or must be removed from service for testing, or are routinely transported for the purpose of use (e.g., vehicle-mounted devices and devices used in multiple locations), the official with statutory authority may require that the devices be brought to a central location for testing. The dealer or owner of these devices shall provide transportation of the devices to and from the test location.
- (b) When the request for removal and delivery to a central test location involves devices used in submetering (e.g., electric, hydrocarbon vapor, or water meters), the owner or operator shall not interrupt the utility service to the customer or tenant except for the removal and replacement of the device. Provisions shall be made by the owner or operator to minimize inconvenience to the customer or tenant. All replacement or temporary meters shall be tested and sealed by a weights and measures official or bear a current, valid approval seal prior to use.

(Added 1994)

Section 2.20. Scales

A. Application

A.1. General. – This code applies to all types of weighing devices other than automatic bulk-weighing systems, belt-conveyor scales, and automatic weighing systems. The code comprises requirements that generally apply to all weighing devices, and specific requirements that are applicable only to certain types of weighing devices.

(Amended 1972 and 1983)

A.2. Wheel-Load Weighers, Portable Axle-Load Weighers, and Axle-Load Scales. – The requirements for wheel-load weighers, portable axle-load weighers, and axle-load scales apply only to such scales in official use for the enforcement of traffic and highway laws or for the collection of statistical information by government agencies.

A.3. Additional Code Requirements. – In addition to the requirements of this code, devices covered by the Scales code shall meet the requirements of Section 1.10. General Code.

S. Specifications

S.1. Design of Indicating and Recording Elements and of Recorded Representations.

S.1.1. Zero Indication.

- (a) On a scale equipped with indicating or recording elements, provision shall be made to either indicate or record a zero-balance condition.
- (b) On an automatic-indicating scale or balance indicator, provision shall be made to indicate or record an out-of-balance condition on both sides of zero.
- (c) A zero-balance condition may be indicated by other than a continuous digital zero indication, provided that an effective automatic means is provided to inhibit a weighing operation or to return to a continuous digital indication when the scale is in an out-of-balance condition.

(Added 1987) (Amended 1993)

(Amended 1987)

S.1.1.1. Digital Indicating Elements.

- (a) A digital zero indication shall represent a balance condition that is within $\pm \frac{1}{2}$ the value of the scale division.
- (b) *A digital indicating device shall either automatically maintain a “center-of-zero” condition to $\pm \frac{1}{4}$ scale division or less, or have an auxiliary or supplemental “center-of-zero” indicator that defines a zero-balance condition to $\pm \frac{1}{4}$ of a scale division or less. A “center-of-zero” indication may operate when zero is indicated for gross and/or net mode(s).*

[Nonretroactive as of January 1, 1993]

(Amended 1992 and 2008)

S.1.1.2. No-Load Reference Value. – On a single draft manually operated receiving hopper scale installed below grade, used to receive grain, and utilizing a no-load reference value, provision shall be made to indicate and record the no-load reference value prior to the gross load value.

(Added 1983)

S.1.2. Value of Scale Division Units. – *Except for batching scales and weighing systems used exclusively for weighing in predetermined amounts, the value of a scale division “d” expressed in a unit of weight shall be equal to:*

- (a) 1, 2, or 5; or
- (b) a decimal multiple or submultiple of 1, 2, or 5; or

Examples: scale divisions may be 10, 20, 50, 100; or 0.01, 0.02, 0.05; or 0.1, 0.2, 0.5, etc.

- (c) a binary submultiple of a specific unit of weight.

Examples: scale divisions may be 1/2, 1/4, 1/8, 1/16, etc.

[Nonretroactive as of January 1, 1986]

S.1.2.1. Digital Indicating Scales, Units. – Except for postal scales, a digital-indicating scale shall indicate weight values using only a single unit of measure. Weight values shall be presented in a decimal format with the value of the scale division expressed as 1, 2, or 5, or a decimal multiple or submultiple of 1, 2, or 5.

The requirement that the value of the scale division be expressed only as 1, 2, or 5, or a decimal multiple or submultiple of only 1, 2, or 5 does not apply to net weight indications and recorded representations that are calculated from gross and tare weight indications where the scale division of the gross weight is different from the scale division of the tare weight(s) on multi-interval or multiple range scales. For example, a multiple range or multi-interval scale may indicate and record tare weights in a lower weighing range (WR) or weighing segment (WS), gross weights in the higher weighing range or weighing segment, and net weights as follows:

| | |
|---|---|
| $\begin{array}{r} 55 \text{ kg} \text{ Gross Weight (WR2 } d = 5 \text{ kg)} \\ - 4 \text{ kg} \text{ Tare Weight (WR1 } d = 2 \text{ kg)} \\ \hline = 51 \text{ kg} \text{ Net Weight (Mathematically Correct)} \end{array}$ | $\begin{array}{r} 10.05 \text{ lb} \text{ Gross Weight (WS2 } d = 0.05 \text{ lb)} \\ - 0.06 \text{ lb} \text{ Tare Weight (WS1 } d = 0.02 \text{ lb)} \\ \hline = 9.99 \text{ lb} \text{ Net Weight (Mathematically Correct)} \end{array}$ |
|---|---|

[Nonretroactive as of January 1, 1989]

(Added 1987) (Amended 2008)

S.1.2.2. Verification Scale Interval.

S.1.2.2.1. Class I and II Scales and Dynamic Monorail Scales. If $e \neq d$, the verification scale interval “e” shall be determined by the expression:

$$d < e \leq 10 d$$

If the displayed division (d) is less than the verification division (e), then the verification division shall be less than or equal to 10 times the displayed division.

The value of e must satisfy the relationship, $e = 10^k$ of the unit of measure, where k is a positive or negative whole number or zero. This requirement does not apply to a Class I device with $d < 1 \text{ mg}$ where $e = 1 \text{ mg}$. If $e \neq d$, the value of “d” shall be a decimal submultiple of “e,” and the ratio shall not be more than 10:1. If $e \neq d$, and both “e” and “d” are continuously displayed during normal operation, then “d” shall be differentiated from “e” by size, shape, color, etc. throughout the range of weights displayed as “d.”

(Added 1999)

S.1.2.2.2. Class III and III Scales. The value of “e” is specified by the manufacturer as marked on the device. Except for dynamic monorail scales, “e” must be less than or equal to “d.”

(Added 1999)

S.1.2.3. Prescription Scale with a Counting Feature. – A Class I or Class II prescription scale with an operational counting feature shall not calculate a piece weight or total count unless the sample used to determine the individual piece weight meets the following conditions:

- (a) minimum individual piece weight is greater than or equal to 3 e; and
- (b) minimum sample piece count is greater than or equal to 10 pieces.

(Added 2003)

S.1.3. Graduations.

S.1.3.1. Length. – Graduations shall be so varied in length that they may be conveniently read.

S.1.3.2. Width. – In any series of graduations, the width of a graduation shall in no case be greater than the width of the clear space between graduations. The width of main graduations shall be not more than 50 % greater than the width of subordinate graduations. Graduations shall be not less than 0.2 mm (0.008 in) wide.

S.1.3.3. Clear Space Between Graduations. – The clear space between graduations shall be not less than 0.5 mm (0.02 in) for graduations representing money-values, and not less than 0.75 mm (0.03 in) for other graduations. If the graduations are not parallel, the measurement shall be made:

- (a) along the line of relative movement between the graduations at the end of the indicator; or
- (b) if the indicator is continuous, at the point of widest separation of the graduations.

S.1.4. Indicators.

S.1.4.1. Symmetry. – The index of an indicator shall be of the same shape as the graduations, at least throughout that portion of its length associated with the graduations.

S.1.4.2. Length. – The index of an indicator shall reach to the finest graduations with which it is used, unless the indicator and the graduations are in the same plane, in which case, the distance between the end of the indicator and the ends of the graduations, measured along the line of the graduations, shall be not more than 1.0 mm (0.04 in).

S.1.4.3. Width. – The width of the index of an indicator in relation to the series of graduations with which it is used shall be not greater than:

- (a) *the width of the narrowest graduation;*
[Nonretroactive as of January 1, 2002]
- (b) the width of the clear space between weight graduations; and
- (c) three-fourths of the width of the clear space between money-value graduations.

When the index of an indicator extends along the entire length of a graduation, that portion of the index of the indicator that may be brought into coincidence with the graduation shall be of the same width throughout the length of the index that coincides with the graduation.

S.1.4.4. Clearance. – The clearance between the index of an indicator and the graduations shall in no case be more than 1.5 mm (0.06 in).

S.1.4.5. Parallax. – Parallax effects shall be reduced to the practicable minimum.

S.1.5. Weighbeams.

S.1.5.1. Normal Balance Position. – The normal balance position of the weighbeam of a beam scale shall be horizontal.

S.1.5.2. Travel. – The weighbeam of a beam scale shall have equal travel above and below the horizontal. The total travel of the weighbeam of a beam scale in a trig loop or between other limiting stops near the

weighbeam tip shall be not less than the minimum travel shown in Tables 1M and 1. When such limiting stops are not provided, the total travel at the weighbeam tip shall be not less than 8 % of the distance from the weighbeam fulcrum to the weighbeam tip.

| Table 1M. Minimum Travel of Weighbeam of Beam Scale Between Limiting Stops | |
|---|---|
| Distance From Weighbeam Fulcrum to Limiting Stops (centimeters) | Minimum Travel Between Limiting Stops (millimeter) |
| 30 or less | 10 |
| 30+ to 50, inclusive | 13 |
| 50+ to 100, inclusive | 18 |
| Over 100 | 23 |

| Table 1. Minimum Travel of Weighbeam of Beam Scale Between Limiting Stops | |
|--|---|
| Distance From Weighbeam Fulcrum to Limiting Stops (inches) | Minimum Travel Between Limiting Stops (inch) |
| 12 or less | 0.4 |
| 12+ to 20, inclusive | 0.5 |
| 20+ to 40, inclusive | 0.7 |
| Over 40 | 0.9 |

S.1.5.3. Subdivision. – A subdivided weighbeam bar shall be subdivided by scale division graduations, notches, or a combination of both. Graduations on a particular bar shall be of uniform width and perpendicular to the top edge of the bar. Notches on a particular bar shall be uniform in shape and dimensions and perpendicular to the face of the bar. When a combination of graduations and notches is employed, the graduations shall be positioned in relation to the notches to indicate notch values clearly and accurately.

S.1.5.4. Readability. – A subdivided weighbeam bar shall be so subdivided and marked, and a weighbeam poise shall be so constructed, that the weight corresponding to any normal poise position can easily and accurately be read directly from the beam, whether or not provision is made for the optional recording of representations of weight.

S.1.5.5. Capacity. – On an automatic-indicating scale having a nominal capacity of 15 kg (30 lb) or less and used for direct sales to retail customers:

- (a) the capacity of any weighbeam bar shall be a multiple of the reading-face capacity;
- (b) each bar shall be subdivided throughout or shall be subdivided into notched intervals, each equal to the reading-face capacity; and
- (c) the value of any turnover poise shall be equal to the reading-face capacity.

S.1.5.6. Poise Stop. – Except on a steelyard with no zero graduation, a shoulder or stop shall be provided on each weighbeam bar to prevent a poise from traveling and remaining back of the zero graduation.

S.1.6. Poises.

S.1.6.1. General. – No part of a poise shall be readily detachable. A locking screw shall be perpendicular to the longitudinal axis of the weighbeam and shall not be removable. Except on a steelyard with no zero graduation, the poise shall not be readily removable from a weighbeam. The knife-edge of a hanging poise shall be hard and sharp and so constructed as to allow the poise to swing freely on the bearing surfaces in the weighbeam notches.

S.1.6.2. Adjusting Material. – The adjusting material in a poise shall be securely enclosed and firmly fixed in position; if softer than brass, it shall not be in contact with the weighbeam.

S.1.6.3. Pawl. – A poise, other than a hanging poise, on a notched weighbeam bar shall have a pawl that will seat the poise in a definite and correct position in any notch, wherever in the notch the pawl is placed, and hold it there firmly and without appreciable movement. The dimension of the tip of the pawl that is transverse to the longitudinal axis of the weighbeam shall be at least equal to the corresponding dimension of the notches.

S.1.6.4. Reading Edge or Indicator. – The reading edge or indicator of a poise shall be sharply defined, and a reading edge shall be parallel to the graduations on the weighbeam.

S.1.7. Capacity Indication, Weight Ranges, and Unit Weights.

- (a) Gross Capacity. An indicating or recording element shall not display nor record any values when the gross load (not counting the initial dead load that has been canceled by an initial zero-setting mechanism) is in excess of 105 % of scale capacity.
- (b) *Capacity Indication. Electronic computing scales (excluding postal scales and weight classifiers) shall neither display nor record a gross or net weight in excess of scale capacity plus 9 d. [Nonretroactive as of January 1, 1993]*

The total value of weight ranges and of unit weights in effect or in place at any time shall automatically be accounted for on the reading face and on any recorded representation.

This requirement does not apply to: (1) single-revolution dial scales, (2) multi-revolution dial scales not equipped with unit weights, (3) scales equipped with two or more weighbeams, nor (4) devices that indicate mathematically derived totalized values.

(Amended 1990, 1992, and 1995)

S.1.8. Computing Scales.

S.1.8.1. Money-Value Graduations, Metric Unit Prices. – The value of the graduated intervals representing money-values on a computing scale with analog indications shall not exceed:

- (a) 1 cent at all unit prices of 55 cents per kilogram and less;
- (b) 2 cents at unit prices of 56 cents per kilogram through \$2.75 per kilogram (special graduations defining 5-cent intervals may be employed but not in the spaces between regular graduations);
- (c) 5 cents at unit prices of \$2.76 per kilogram through \$7.50 per kilogram; or
- (d) 10 cents at unit prices above \$7.50 per kilogram.

Value figures and graduations shall not be duplicated in any column or row on the graduated chart. (~~See~~ Also S.1.8.2. Money-Value Computation.)

S.1.8.2. Money-Value Graduations, Inch-Pound Unit Prices. – The value of the graduated intervals representing money-values on a computing scale with analog indications shall not exceed:

- (a) 1 cent at all unit prices of 25 cents per pound and less;
- (b) 2 cents at unit prices of 26 cents per pound through \$1.25 per pound (special graduations defining 5-cent intervals may be employed but not in the spaces between regular graduations);
- (c) 5 cents at unit prices of \$1.26 per pound through \$3.40 per pound; or
- (d) 10 cents at unit prices above \$3.40 per pound.

Value figures and graduations shall not be duplicated in any column or row on the graduated chart. (~~See~~ also Also S.1.8.2. Money-Value Computation.)

S.1.8.3. Money-Value Computation. – A computing scale with analog quantity indications used in retail trade may compute and present digital money-values to the nearest quantity graduation when the value of the

minimum graduated interval is 0.005 kg (0.01 lb) or less. (~~See also~~ Also see Sec. 1.10. General Code G-S.5.5. Money-Values, Mathematical Agreement.)

S.1.8.4. Customer's Indications. – Weight indications shall be shown on the customer's side of computing scales when these are used for direct sales to retail customers. Computing scales equipped on the operator's side with digital indications, such as the net weight, unit price, or total price, shall be similarly equipped on the customer's side. Unit price displays visible to the customer shall be in terms of single whole units of weight and not in common or decimal fractions of the unit. Scales indicating in metric units may indicate price per 100 g.

(Amended 1985 and 1995)

S.1.8.4.1. *Scales that will function as either a normal round off scale or as a weight classifier shall be provided with a sealable means for selecting the mode of operation and shall have a clear indication (annunciator), adjacent to the weight display on both the operator's and customer's side whenever the scale is operating as a weight classifier.*

[Nonretroactive as of January 1, 2001]

(Added 1999)

S.1.8.5. Recorded Representations, Point-of-Sale Systems. – The sales information recorded by cash registers when interfaced with a weighing element shall contain the following information for items weighed at the checkout stand:

- (a) the net weight;²⁷
- (b) the unit price;¹
- (c) the total price; and
- (d) the product class or, in a system equipped with price look-up capability, the product name or code number.

S.1.9. Prepackaging Scales.

S.1.9.1. Value of the Scale Division. – On a prepackaging scale, the value of the intervals representing weight values shall be uniform throughout the entire reading face. The recorded weight values shall be identical with those on the indicator.

S.1.9.2. Label Printer. – A prepackaging scale or a device that produces a printed ticket to be used as the label for a package shall print all values digitally and of such size, style of type, and color as to be clear and conspicuous on the label.

S.1.10. Adjustable Components. – An adjustable component such as a pendulum, spring, or potentiometer shall be held securely in adjustment and, except for a zero-load balance mechanism, shall be located within the housing of the element.

(Added 1986)

²⁷ For devices interfaced with scales indicating in metric units, the unit price may be expressed in price per 100 grams. Weight values shall be identified by kilograms, kg, grams, g, ounces, oz, pounds, or lb. *The “#” symbol is not acceptable.*

[Nonretroactive as of January 1, 2006]

(Amended 1995 and 2005)

S.1.11. Provision for Sealing.

- (a) *Except on Class I scales, provision shall be made for applying a security seal in a manner that requires the security seal to be broken before an adjustment can be made to any component affecting the performance of an electronic device.*
[Nonretroactive as of January 1, 1979]
- (b) *Except on Class I scales, a device shall be designed with provision(s) for applying a security seal that must be broken, or for using other approved means of providing security (e.g., data change audit trail available at the time of inspection), before any change that detrimentally affects the metrological integrity of the device can be made to any electronic mechanism.*
[Nonretroactive as of January 1, 1990]
- (c) *Except on Class I scales, audit trails shall use the format set forth in Table S.1.11.*
[Nonretroactive as of January 1, 1995]

A device may be fitted with an automatic or a semi-automatic calibration mechanism. This mechanism shall be incorporated inside the device. After sealing, neither the mechanism nor the calibration process shall facilitate fraud. (Amended 1989, 1991, and 1993)

| Table S.1.11. Categories of Device and Methods of Sealing | |
|--|--|
| Categories of Device | Methods of Sealing |
| Category 1: No remote configuration capability. | Seal by physical seal or two event counters: one for calibration parameters and one for configuration parameters. |
| Category 2: Remote configuration capability, but access is controlled by physical hardware. The device shall clearly indicate that it is in the remote configuration mode and record such message if capable of printing in this mode. | The hardware enabling access for remote communication must be at the device and sealed using a physical seal or two event counters: one for calibration parameters and one for configuration parameters. |
| Category 3: Remote configuration capability access may be unlimited or controlled through a software switch (e.g., password). | An event logger is required in the device; it must include an event counter (000 to 999), the parameter ID, the date and time of the change, and the new value of the parameter. A printed copy of the information must be available through the device or through another on-site device. The event logger shall have a capacity to retain records equal to 10 times the number of sealable parameters in the device, but not more than 1000 records are required. (Note: Does not require 1000 changes to be stored for each parameter.) |

[Nonretroactive as of January 1, 1995]

(Table added 1993)

S.1.12. Manual Weight Entries. – A device when being used for direct sale shall accept an entry of a manual gross or net weight value only when the scale gross or net* weight indication is at zero. Recorded manual weight entries, except those on labels generated for packages of standard weights, shall identify the weight value as a manual weight entry by one of the following terms: “Manual Weight,” “Manual Wt,” or “MAN WT.” The use of a symbol to identify multiple manual weight entries on a single document is permitted, provided that the symbol is defined on the same page on which the manual weight entries appear and the definition of the symbol is automatically printed by the recording element as part of the document.

[Nonretroactive as of January 1, 1993] [*Nonretroactive as of January 1, 2005]

(Added 1992) (Amended 2004)

S.1.13. Vehicle On-Board Weighing Systems: Vehicle in Motion. – When the vehicle is in motion, a vehicle on-board weighing system shall either:

- (a) be accurate; or
- (b) inhibit the weighing operation.

(Added 1993)

S.2. Design of Balance, Tare, Level, Damping, and Arresting Mechanisms.

S.2.1. Zero-Load Adjustment.

S.2.1.1. General. – A scale shall be equipped with means by which the zero-load balance may be adjusted. Any loose material used for this purpose shall be enclosed so that it cannot shift in position and alter the balance condition of the scale.

Except for an initial zero-setting mechanism, an automatic zero adjustment outside the limits specified in S.2.1.3. Scales Equipped with an Automatic Zero-Tracking Mechanism is prohibited.

(Amended 2010)

S.2.1.2. Scales used in Direct Sales. – A manual zero-setting mechanism (except on a digital scale with an analog zero-adjustment mechanism with a range of not greater than one scale division) shall be operable or accessible only by a tool outside of and entirely separate from this mechanism, or it shall be enclosed in a cabinet. Except on Class I or II scales, a balance ball shall either meet this requirement or not itself be rotatable.

A semiautomatic zero-setting mechanism shall be operable or accessible only by a tool outside of and separate from this mechanism or it shall be enclosed in a cabinet, or it shall be operable only when the indication is stable within plus or minus:

- (a) 3.0 scale divisions for scales of more than 2000 kg (5000 lb) capacity in service prior to January 1, 1981, and for all axle load, railway track, and vehicle scales; or
- (b) 1.0 scale division for all other scales.

S.2.1.3. Scales Equipped with an Automatic Zero-Tracking Mechanism.

S.2.1.3.1. Automatic Zero-Tracking Mechanism for Scales Manufactured Between January 1, 1981, and January 1, 2007. – The maximum load that can be “rezeroed,” when either placed on or removed from the platform all at once under normal operating conditions, shall be for:

- (a) bench, counter, and livestock scales: 0.6 scale division;
- (b) vehicle, axle load, and railway track scales: 3.0 scale divisions; and
- (c) all other scales: 1.0 scale division.

(Amended 2005)

S.2.1.3.2. Automatic Zero-Tracking Mechanism for Scales Manufactured on or after January 1, 2007. – The maximum load that can be “rezeroed,” when either placed on or removed from the platform all at once under normal operating conditions, shall be:

- (a) for vehicle, axle load, and railway track scales: 3.0 scale divisions; and
- (b) for all other scales: 0.5 scale division.

(Added 2005)

S.2.1.3.3. Means to Disable Automatic Zero-Tracking Mechanism on Class III L Devices. – *Class III L devices equipped with an automatic zero-tracking mechanism shall be designed with a sealable means that would allow zero tracking to be disabled during the inspection and test of the device.*
[Nonretroactive as of January 1, 2001]

(Added 1999) (Amended 2005)

S.2.1.4. Monorail Scales. – On a static monorail scale equipped with digital indications, means shall be provided for setting the zero-load balance to within 0.02 % of scale capacity. On a dynamic monorail weighing system, means shall be provided to automatically maintain these conditions.

(Amended 1999)

S.2.1.5. Initial Zero-Setting Mechanism. – Scales of accuracy Classes I, II, and III may be equipped with an initial zero-setting device.

- (a) For weighing, load-receiving, and indicating elements in the same housing or covered on the same CC, an initial zero-setting mechanism shall not zero a load in excess of 20 % of the maximum capacity of the scale unless tests show that the scale meets all applicable tolerances for any amount of initial load compensated by this device within the specified range.

(b) *For indicating elements not permanently attached to weighing and load-receiving elements covered on a separate CC, the maximum initial zero-setting mechanism range of electronic indicators shall not exceed 20 % of the configured capacity.*

[Nonretroactive as of January 1, 2009]

(Added 2008)

(Added 1990) (Amended 2008)

S.2.1.6. Combined Zero-Tare (“0/T”) Key. – Scales not intended to be used in direct sales applications may be equipped with a combined zero and tare function key, provided that the device is clearly marked as to how the key functions. The device must also be clearly marked on or adjacent to the weight display with the statement “Not for Direct Sales.”

(Added 1998)

S.2.2. Balance Indicator. – On a balance indicator consisting of two indicating edges, lines, or points, the ends of the indicators shall be sharply defined. When the scale is in balance, the ends shall be separated by not more than 1.0 mm (0.04 in).

S.2.2.1. Dairy-Product Test, Grain-Test, Prescription, and Class I and II Scales. – Except on digital indicating devices, a dairy-product test, grain-test, prescription, or Class I or II scale shall be equipped with a balance indicator. If an indicator and a graduated scale are not in the same plane, the clearance between the indicator and the graduations shall be not more than 1.0 mm (0.04 in).

S.2.2.2. Equal-Arm Scale. – *An equal-arm scale shall be equipped with a balance indicator. If the indicator and balance graduation are not in the same plane, the clearance between the indicator and the balance graduation shall be not more than 1.0 mm (0.04 in).*

[Nonretroactive as of January 1, 1989]

(Added 1988)

S.2.3. Tare. – *On any scale (except a monorail scale equipped with digital indications and multi-interval scales or multiple range scales when the value of tare is determined in a lower weighing range or weighing segment), the value of the tare division shall be equal to the value of the scale division.* The tare mechanism shall operate only in a backward direction (that is, in a direction of underregistration) with respect to the zero-load balance condition of the scale. A device designed to automatically clear any tare value shall also be designed to prevent the automatic clearing of tare until a complete transaction has been indicated.**

*[*Nonretroactive as of January 1, 1983]*

(Amended 1985 and 2008)

Note: *On a computing scale, this requires the input of a unit price, the display of the unit price, and a computed positive total price at a readable equilibrium. Other devices require a complete weighing operation, including tare, net, and gross weight determination**

*[*Nonretroactive as of January 1, 1983]*

S.2.3.1. Monorail Scales Equipped with Digital Indications. – On a static monorail weighing system equipped with digital indications, means shall be provided for setting any tare value of less than 5 % of the scale capacity to within 0.02 % of scale capacity. On a dynamic monorail weighing system, means shall be provided to automatically maintain this condition.

(Amended 1999)

S.2.4. Level-Indicating Means. – Except for portable wheel-load weighers and portable axle load scales, a portable scale shall be equipped with level-indicating means if its weighing performance is changed by an amount greater than the appropriate acceptance tolerance when it is tilted up to and including 5 % rise over run in any direction from a level position and rebalanced. The level-indicating means shall be readable without removing any scale parts requiring a tool.

[This requirement is nonretroactive as of January 1, 1986, for prescription, jewelers’, and dairy-product test scales and scales marked Class I and II.]

Note: Portable wheel-load weighers and portable axle-load scales shall be accurate when tilted up to and including 5% rise over run in any direction from a level position and rebalanced.

(Amended 1991 and 2008)

S.2.4.1. Vehicle On-Board Weighing Systems. – A vehicle on-board weighing system shall operate within tolerance when the weighing system is tilted up to and including 5% rise over run in any direction from a level position and rebalanced. If the accuracy of the system is affected by out-of-level conditions normal to the use of the device, the system shall be equipped with an out-of-level sensor that inhibits the weighing operation when the system is out of level to the extent that the accuracy limits are exceeded.

(Added 1992) (Amended 2008)

S.2.5. Damping Means. – An automatic-indicating scale and a balance indicator shall be equipped with effective means to damp oscillations and to bring the indicating elements quickly to rest.

S.2.5.1. Digital Indicating Elements. – Digital indicating elements equipped with recording elements shall be equipped with effective means to permit the recording of weight values only when the indication is stable within plus or minus:

- (a) 3.0 scale divisions for scales of more than 2000 kg (5000 lb) capacity in service prior to January 1, 1981, hopper (other than grain hopper) scales with a capacity exceeding 22 000 kg (50 000 lb), and for all vehicle, axle load, livestock, and railway track scales; and
- (b) 1.0 scale division for all other scales.

The values recorded shall be within applicable tolerances.

(Amended 1995)

S.2.5.2. Jewelers', Prescription, and Class I, and Class II Scales. – A jewelers', prescription, Class I, or Class II scales shall be equipped with appropriate means for arresting the oscillation of the mechanism.

S.2.5.3. Class I and Class II Prescription Scales with a Counting Feature. – A Class I or Class II prescription scale shall indicate to the operator when the piece weight computation is complete by a stable display of the quantity placed on the load-receiving element.

(Added 2003)

S.3. Design of Load-Receiving Elements.

S.3.1. Travel of Pans of Equal-Arm Scale. – The travel between limiting stops of the pans of a nonautomatic-indicating equal-arm scale not equipped with a balance indicator shall be not less than the minimum travel shown in Table 2M and Table 2.

| Table 2M. Minimum Travel of Pans of Nonautomatic Indicating Equal-Arm Scale Without Balance Indicator | |
|--|---|
| Nominal Capacity (kilograms) | Minimum Travel of Pans (millimeters) |
| 2 or less | 9 |
| 2+ to 5, inclusive | 13 |
| 5+ to 12, inclusive | 19 |
| Over 12 | 25 |

| Table 2. Minimum Travel of Pans of Nonautomatic Indicating Equal-Arm Scale Without Balance Indicator | |
|---|----------------------------------|
| Nominal Capacity (pounds) | Minimum Travel of Pans (inch) |
| 4 or less | 0.35 |
| 4+ to 12, inclusive | 0.5 |
| 12+ to 26, inclusive | 0.75 |
| Over 26 | 1.0 |

S.3.2. Drainage. – A load-receiving element intended to receive wet commodities shall be so constructed as to drain effectively.

S.3.3. Scoop Counterbalance. – A scoop on a scale used for direct sales to retail customers shall not be counterbalanced by a removable weight. A permanently attached scoop-counterbalance shall indicate clearly on both the operator’s and customer’s sides of the scale whether it is positioned for the scoop to be on or off the scale.

S.4. Design of Weighing Elements.

S.4.1. Antifriction Means. – Frictional effects shall be reduced to a minimum by suitable antifriction elements. Opposing surfaces and points shall be properly shaped, finished, and hardened. A platform scale having a frame around the platform shall be equipped with means to prevent interference between platform and frame.

S.4.2. Adjustable Components. – An adjustable component such as a nose-iron or potentiometer shall be held securely in adjustment. The position of a nose-iron on a scale of more than 1000 kg (2000 lb) capacity, as determined by the factory adjustment, shall be accurately, clearly, and permanently defined.

(Amended 1986)

S.4.3. Multiple Load-Receiving Elements. – Except for mechanical bench and counter scales, a scale with a single indicating or recording element, or a combination indicating-recording element, that is coupled to two or more load-receiving elements with independent weighing systems, shall be provided with means to prohibit the activation of any load-receiving element (or elements) not in use, and shall be provided with automatic means to indicate clearly and definitely which load-receiving element (or elements) is in use.

S.5. Design of Weighing Devices, Accuracy Class.

S.5.1. Designation of Accuracy Class. – Weighing devices are divided into accuracy classes and shall be designated as I, II, III, III L, or IIII.

[Nonretroactive as of January 1, 1986]

S.5.2. Parameters for Accuracy Class. – The accuracy class of a weighing device is designated by the manufacturer and shall comply with parameters shown in Table 3.

[Nonretroactive as of January 1, 1986]

S.5.3. Multi-Interval and Multiple Range Scales, Division Value. – On a multi-interval scale and multiple range scale, the value of “e” shall be equal to the value of “d.”²⁸

(Added 1986) (Amended 1995)

S.5.4. Relationship of Load Cell Verification Interval Value to the Scale Division. – The relationship of the value for the load cell verification scale interval, v_{\min} , to the scale division, d , for a specific scale installation using National Type Evaluation Program (NTEP) load cells shall comply with the following formulae where N is the number of load cells in the scale (such as hopper or vehicle scale weighing/load-receiving elements):

$$(a) \quad v_{\min} \leq \frac{d^*}{\sqrt{N}} \quad \text{for scales without lever systems; and}$$

$$(b) \quad v_{\min} \leq \frac{d^*}{\sqrt{N} \times (\text{scale multiple})} \quad \text{for scales with lever systems.}$$

[*When the value of the scale division, d , is different from the verification scale division, e , for the scale, the value of e must be used in the formulae above.]

²⁸ See Footnote 1 to Table 3 Parameters for Accuracy Classes.

This requirement does not apply to complete weighing/load-receiving elements or scales, which satisfy all the following criteria:

- *the complete weighing/load-receiving element or scale has been evaluated for compliance with T.N.8.1. Temperature under the NTEP;*
- *the complete weighing/load-receiving element or scale has received an NTEP Certificate of Conformance; and*
- *the complete weighing/load-receiving element or scale is equipped with an automatic zero-tracking mechanism which cannot be made inoperative in the normal weighing mode. (A test mode which permits the disabling of the automatic zero-tracking mechanism is permissible, provided the scale cannot function normally while in this mode.*

[Nonretroactive as of January 1, 1994]

(Added 1993) (Amended 1996)

MARKUP COPY

| Table 3. Parameters for Accuracy Classes | | | |
|--|--|--|----------------|
| <i>Class</i> | <i>Value of the Verification Scale Division (d or e¹)</i> | <i>Number of Scale⁴ Divisions (n)</i> | |
| | | <i>Minimum</i> | <i>Maximum</i> |
| SI Units | | | |
| <i>I</i> | <i>equal to or greater than 1 mg</i> | <i>50 000</i> | <i>--</i> |
| <i>II</i> | <i>1 to 50 mg, inclusive</i> | <i>100</i> | <i>100 000</i> |
| | <i>equal to or greater than 100 mg</i> | <i>5 000</i> | <i>100 000</i> |
| <i>III^{2,5}</i> | <i>0.1 to 2 g, inclusive</i> | <i>100</i> | <i>10 000</i> |
| | <i>equal to or greater than 5 g</i> | <i>500</i> | <i>10 000</i> |
| <i>III L³</i> | <i>equal to or greater than 2 kg</i> | <i>2 000</i> | <i>10 000</i> |
| <i>III</i> | <i>equal to or greater than 5 g</i> | <i>100</i> | <i>1 200</i> |
| Inch-Pound Units | | | |
| <i>III⁵</i> | <i>0.0002 lb to 0.005 lb, inclusive</i> | <i>100</i> | <i>10 000</i> |
| | <i>0.005 oz to 0.125 oz, inclusive</i> | <i>100</i> | <i>10 000</i> |
| | <i>equal to or greater than 0.01 lb</i> | <i>500</i> | <i>10 000</i> |
| | <i>equal to or greater than 0.25 oz</i> | <i>500</i> | <i>10 000</i> |
| <i>III L³</i> | <i>equal to or greater than 5 lb</i> | <i>2 000</i> | <i>10 000</i> |
| <i>III</i> | <i>greater than 0.01 lb</i> | <i>100</i> | <i>1 200</i> |
| | <i>greater than 0.25 oz</i> | <i>100</i> | <i>1 200</i> |
| <p>¹ For Class I and II devices equipped with auxiliary reading means (i.e., a rider, a vernier, or a least significant decimal differentiated by size, shape, or color), the value of the verification scale division “e” is the value of the scale division immediately preceding the auxiliary means.</p> <p>² A Class III scale marked “For prescription weighing only” may have a verification scale division (e) not less than 0.01 g. (Added 1986) (Amended 2003)</p> <p>³ The value of a scale division for crane and hopper (other than grain hopper) scales shall be not less than 0.2 kg (0.5 lb). The minimum number of scale divisions shall be not less than 1000.</p> <p>⁴ On a multiple range or multi-interval scale, the number of divisions for each range independently shall not exceed the maximum specified for the accuracy class. The number of scale divisions, n, for each weighing range is determined by dividing the scale capacity for each range by the verification scale division, e, for each range. On a scale system with multiple load-receiving elements and multiple indications, each element considered shall not independently exceed the maximum specified for the accuracy class. If the system has a summing indicator, the n_{max} for the summed indication shall not exceed the maximum specified for the accuracy class. (Added 1997)</p> <p>⁵ The minimum number of scale divisions for a Class III Hopper Scale used for weighing grain shall be 2000.)</p> | | | |

[Nonretroactive as of January 1, 1986]

(Added 2004) (Amended 1986, 1987, 1997, 1998, 1999, 2003, and 2004)

S.6. Marking Requirements. ~~{See—(also G-S.1. Identification, G-S.4. Interchange or Reversal of Parts, G-S.6. Marking Operational Controls, Indications, and Features, G-S.7. Lettering, G-UR.2.1.1. Visibility of Identification, and UR.3.4.1. Use in Pairs)}~~

S.6.1. Nominal Capacity; Vehicle and Axle-Load Scales. – For all vehicle and axle-load scales, the marked nominal capacity shall not exceed the concentrated load capacity (CLC) times the quantity of the number of sections in the scale minus 0.5.

As a formula, this is stated as:
$$\text{nominal capacity} \leq \text{CLC} \times (N - 0.5)$$
 where N = the number of sections in the scale.

(See also N.1.3.3. Vehicle Scales, Axle-Load Scales, and Livestock Scales and T.N.3.1. Maintenance Tolerance Values.)

[Nonretroactive as of January 1, 1989]

Note: When the device is used in a combination railway track and vehicle weighing application, the above formula shall apply only to the vehicle scale application.

(Added 1988) (Amended 1999 and 2002)

S.6.2. Location of Marking Information. – Scales that are not permanently attached to an indicating element, and for which the load-receiving element is the only part of the weighing/load-receiving element visible after installation, may have the marking information required in G-S.1. of the General Code and S.6. of the Scales Code located in an area that is accessible only through the use of a tool; provided that the information is easily accessible (e.g., the information may appear on the junction box under an access plate). The identification information for these scales shall be located on the weighbridge (load-receiving element) near the point where the signal leaves the weighing element or beneath the nearest access cover.

(Added 1989)

S.6.3. Scales, Main Elements, and Components of Scales or Weighing Systems. – Scales, main elements of scales when not contained in a single enclosure for the entire scale, load cells for which Certificates of Conformance (CC) have been issued under the National Type Evaluation Program (NTEP), and other equipment necessary to a weighing system, but having no metrological effect on the weighing system, shall be marked as specified in Table S.6.3.a. Marking Requirements and explained in the accompanying notes in Table S.6.3.b. Notes for Table S.6.3.a.

(Added 1990)

| Table S.6.3.a. Marking Requirements | | | | | |
|---|---|---|---|-------------------------------|---------------------------------------|
| To Be Marked With ↓ | Weighing Equipment | | | | |
| | Weighing, Load-Receiving, and Indicating Element in Same Housing or Covered on the Same CC¹ | Indicating Element not Permanently Attached to Weighing and Load-Receiving Element or Covered by a Separate CC | Weighing and Load-Receiving Element Not Permanently Attached to Indicating Element or Covered by a Separate CC | Load Cell with CC (11) | Other Equipment or Device (10) |
| Manufacturer’s ID (1) | X | X | X | X | X |
| Model Designation and Prefix (1) | X | X | X | X | X |
| Serial Number and Prefix (2) | X | X | X | X | X (16) |
| Certificate of Conformance Number (CC) (23) | X | X | X | X | X (23) |
| Accuracy Class (17) | X | X (8) | X (19) | X | |
| Nominal Capacity (3)(18)(20) | X | X | X | | |
| Value of Scale Division, “d” (3) | X | X | | | |
| Value of “e” (4) | X | X | | | |
| Temperature Limits (5) | X | X | X | X | |
| Concentrated Load Capacity (CLC) (12)(20)(22) | | X | X (9) | | |
| Special Application (13) | X | X | X | | |
| Maximum Number of Scale Divisions (n _{max}) (6) | | X (8) | X (19) | X | |
| Minimum Verification Scale Division (e _{min}) | | | X (19) | | |
| “S” or “M” (7) | | | | X | |
| Direction of Loading (15) | | | | X | |
| Minimum Dead Load | | | | X | |
| Maximum Capacity | | | | X | |
| Safe Load Limit | | | | X | |
| Load Cell Verification Interval (v _{min}) (21) | | | | X | |
| Section Capacity and Prefix (14)(20)(22)(24) | | X | X | | |

Note: For applicable notes, see Table S.6.3.b.

¹ Weighing/load-receiving elements and indicators which are in the same housing or which are permanently attached will generally appear on the same CC. If not in the same housing, elements shall be hard-wired together or sealed with a physical seal or an electronic link. This requirement does not apply to peripheral equipment that has no input or effect on device calibrations or configurations.

(Added 2001)

(Added 1990) (Amended 1992, 1999, 2000, 2001, 2002, and 2004)

Table S.6.3.b.
Notes for Table S.6.3.a. Marking Requirements

1. Manufacturer's identification and model designation and *model designation prefix*.*
[*Nonretroactive as of January 1, 2003]
(See also G-S.1. Identification.) [Prefix lettering may be initial capitals, all capitals or all lower case]
(Amended 2000)
2. *Serial number* [Nonretroactive as of January 1, 1968] and *prefix* [Nonretroactive as of January 1, 1986]. (See also G-S.1. Identification.)
3. The device shall be marked with the nominal capacity. *The nominal capacity shall be shown together with the value of the scale division (e.g., 15 x 0.005 kg, 30 x 0.01 lb, or capacity = 15 kg, d = 0.005 kg) in a clear and conspicuous manner and be readily apparent when viewing the reading face of the scale indicator unless already apparent by the design of the device. Each scale division value or weight unit shall be marked on multiple range or multi-interval scales.*
[Nonretroactive as of January 1, 1983]
(Amended 2005)
4. *Required only if different from "d."*
[Nonretroactive as of January 1, 1986]
5. *Required only on Class III, III L, and IIII devices if the temperature range on the NTEP CC is narrower than and within - 10 °C to 40 °C (14 °F to 104 °F).* [Nonretroactive as of January 1, 1986]
(Amended 1999)
6. *This value may be stated on load cells in units of 1000; e.g., n: 10 is 10 000 divisions.*
[Nonretroactive as of January 1, 1988]
7. *Denotes compliance for single or multiple load cell applications. It is acceptable to use a load cell with the "S" or Single Cell designation in multiple load cell applications as long as all other parameters meet applicable requirements. A load cell with the "M" or Multiple Cell designation can be used only in multiple load cell applications.*
[Nonretroactive as of January 1, 1988]
(Amended 1999)
8. *An indicating element not permanently attached to a weighing element shall be clearly and permanently marked with the accuracy Class of I, II, III, III L, or IIII, as appropriate, and the maximum number of scale divisions, n_{max} , for which the indicator complies with the applicable requirement. Indicating elements that qualify for use in both Class III and III L applications may be marked III/III L and shall be marked with the maximum number of scale divisions for which the device complies with the applicable requirements for each accuracy class.*
[Nonretroactive as of January 1, 1988]
9. *For vehicle and axle-load scales only. The CLC shall be added to the load-receiving element of any such scale not previously marked at the time of modification.*
[Nonretroactive as of January 1, 1989]
(Amended 2002)
10. Necessary to the weighing system but having no metrological effect, e.g., auxiliary remote display, keyboard, etc.
11. *The markings may be either on the load cell or in an accompanying document; except that, if an accompanying document is provided, the serial number shall appear both on the load cell and in the document.* [Nonretroactive as of January 1, 1988] *The manufacturer's name or trademark, the model designation, and identifying symbols for the model and serial numbers as required by paragraph G-S.1. Identification shall also be marked both on the load cell and in any accompanying document.*
[Nonretroactive as of January 1, 1991]

Table S.6.3.b.
Notes for Table S.6.3.a. Marking Requirements

12. Required on the indicating element *and the load-receiving element* of vehicle and axle-load scales. *Such marking shall be identified as “concentrated load capacity” or by the abbreviation “CLC.”**
*[*Nonretroactive as of January 1, 1989]*
 (Amended 2002)
13. *A scale designed for a special application rather than general use shall be conspicuously marked with suitable words, visible to the operator and to the customer, restricting its use to that application, e.g., postal scale, prepack scale, weight classifier, etc.** When a scale is installed with an operational counting feature, the scale shall be marked on both the operator and customer sides with the statement “The counting feature is not legal for trade,” except when a Class I or Class II prescription scale complies with all Handbook 44 requirements applicable to counting features.
*[*Nonretroactive as of 1986]*
 (Amended 1994 and 2003)
14. Required on *livestock** and railway track scales. When marked on vehicle and axle-load scales manufactured before January 1, 1989, it may be used as the CLC. For livestock scales manufactured between January 1, 1989, and January 1, 2003, required markings may be either CLC or section capacity.
*[*Nonretroactive as of January 1, 2003]*
 (Amended 2002)
15. *Required if the direction of loading the load cell is not obvious.*
[Nonretroactive as of January 1, 1988]
16. *Serial number [Nonretroactive as of January 1, 1968] and prefix [Nonretroactive as of January 1, 1986]. (See also G-S.1. Identification).* Modules without “intelligence” on a modular system (e.g., printer, keyboard module, cash drawer, and secondary display in a point-of-sale system) are not required to have serial numbers.
17. *The accuracy class of a device shall be marked on the device with the appropriate designation as I, II, III, III L, or IIII.*
[Nonretroactive as of January 1, 1986]
18. The nominal capacity shall be conspicuously marked as follows:
 (a) on any scale equipped with unit weights or weight ranges;
 (b) on any scale with which counterpoise or equal-arm weights are intended to be used;
 (c) on any automatic-indicating or recording scale so constructed that the capacity of the indicating or recording element, or elements, is not immediately apparent;
 (d) on any scale with a nominal capacity less than the sum of the reading elements; and
 (e) *on the load-receiving element (weighbridge) of vehicle, axle-load, and livestock scales.**
*[*Nonretroactive as of January 1, 1989]*
 (Amended 1992)
19. *For weighing and load-receiving elements not permanently attached to indicating element or covered by a separate CC.*
[Nonretroactive as of January, 1, 1988]
 (Amended 1992)
20. *Combination vehicle/railway track scales must be marked with both the nominal capacity and CLC for vehicle weighing and the nominal capacity and section capacity for railway weighing. All other requirements relating to these markings will apply.*
[Nonretroactive as of January 1, 2000]
 (Added 1999)
21. *The value of the load cell verification interval (v_{min}) must be stated in mass units. In addition to this information, a device may be marked with supplemental representations of v_{min} .*
[Nonretroactive as of January 1, 2001]
 (Added 1999)

| Table S.6.3.b. | |
|--|--|
| Notes for Table S.6.3.a. Marking Requirements | |
| <p>22. <i>Combination vehicle/livestock scales must be marked with both the CLC for vehicle weighing and the section capacity for livestock weighing. All other requirements relative to these markings will apply.</i> <i>[Nonretroactive as of January 1, 2003]</i> (Added 2002) (Amended 2003)</p> <p><i>Note: The marked section capacity for livestock weighing may be less than the marked CLC for vehicle weighing.</i> (Amended 2003)</p> | |
| <p>23. <i>Required only if a CC has been issued for the device or equipment.</i> <i>[Nonretroactive as of January 1, 2003]</i> (G-S.1. Identification (e) Added 2001)</p> | |
| <p>24. <i>The section capacity shall be prefaced by the words “Section Capacity” or an abbreviation of that term. Abbreviations shall be “Sec Cap” or “Sec C.” All capital letters and periods may be used.</i> <i>[Nonretroactive as of January 1, 2005]</i> (Added 2004)</p> | |

S.6.4. Railway Track Scales. – A railway track scale shall be marked with the maximum capacity of each section of the load-receiving element of the scale. Such marking shall be accurately and conspicuously presented on, or adjacent to, the identification or nomenclature plate that is attached to the indicating element of the scale. ~~The nominal capacity of a scale with more than two sections shall not exceed twice its rated section capacity. The nominal capacity of a two section scale shall not exceed its rated section capacity.~~ ^{*}The nominal capacity marking shall satisfy the following:

- (a) ~~[*Nonretroactive as of~~ **For scales manufactured from January 1, 2002, through December 31, 2013:**
 - (1) the nominal capacity of a scale with more than two sections shall not exceed twice its rated section capacity; and**
 - (2) the nominal capacity of a two section scale shall not exceed its rated section capacity.**
 - (b) **For scales manufactured on or after January 1, 2014, the nominal scale capacity shall not exceed the lesser of:**
 - (1) the sum of the Weigh Module Capacities as shown in Table S.6.4.M. and Table S.6.4.; or**
 - (2) the Rated Section Capacity (RSC) multiplied by the Number of Sections (Ns) minus the Number of Dead Spaces (Nd) minus 0.5. As a formula this is stated as:**

$$\underline{RSC \times (Ns - Nd - 0.5); \text{ or}}$$
 - (3) 290 300 kg (640 000 lb).**
- (Amended 1988, 2001, ~~and 2002,~~ **and 2013**)

| Table S.6.4.M. | |
|---|--|
| Railway Track Scale – Weigh Module Capacity | |
| <u>Weigh Module Length</u> <u>(meters)</u> | <u>Weigh Module Capacity</u> <u>(kilograms)</u> |
| <u>< 1.5</u> | <u>36 300</u> |
| <u>1.5 to < 3.0</u> | <u>72 600</u> |
| <u>3.0 to < 4.5</u> | <u>108 900</u> |

| | |
|---|----------------|
| <u>4.5 to < 7.0</u> | <u>145 100</u> |
| <u>7.0 to < 9.0</u> | <u>168 700</u> |
| <u>9.0 to < 10.5</u> | <u>192 300</u> |
| <u>10.5 to < 12.0</u> | <u>234 100</u> |
| <u>12.0 to < 17.0</u> | <u>257 600</u> |
| Note: The capacity of a particular module is based on its length as shown above. To determine the “sum of the weigh module capacities” referenced in paragraph S.6.4.(b)(1): (1) determine the length of each individual weigh module in the scale; (2) find its corresponding “weigh module capacity” in the table above; and (3) add all of the individual weigh module capacities.” | |

(Table Added 2013)

| Table S.6.4. Railway Track Scale – Weigh Module Capacity | |
|---|---|
| <u>Weigh Module Length (feet)</u> | <u>Weigh Module Capacity (pounds)</u> |
| <u>≤ 5</u> | <u>80 000</u> |
| <u>5 to < 10</u> | <u>160 000</u> |
| <u>10 to < 15</u> | <u>240 000</u> |
| <u>15 to < 23</u> | <u>320 000</u> |
| <u>23 to < 29</u> | <u>372 000</u> |
| <u>29 to < 35</u> | <u>424 000</u> |
| <u>35 to < 40</u> | <u>516 000</u> |
| <u>40 to < 56</u> | <u>568 000</u> |
| Note: The capacity of a particular module is based on its length as shown above. To determine the “sum of the weigh module capacities” referenced in paragraph S.6.4.(b)(1): (1) determine the length of each individual weigh module in the scale; (2) find its corresponding “weigh module capacity” in the table above; and (3) add all of the individual weigh module capacities.” | |

(Table Added 2013)

S.6.5. Livestock Scales. – A livestock scale manufactured prior to January 1, 1989, or after January 1, 2003, shall be marked with the maximum capacity of each section of the load-receiving element of the scale. Livestock scales manufactured between January 1, 1989, and January 1, 2003, shall be marked with either the Concentrated Load Capacity (CLC) or the Section Capacity. Such marking shall be accurately and conspicuously presented on, or adjacent to the identification or nomenclature plate that is attached to the indicating element of the scale. *The nominal capacity of a scale with more than two sections shall not exceed twice its rated section capacity. The nominal capacity of a two-section scale shall not exceed its rated section capacity.**

[*Nonretroactive as of January 1, 2003]

(Added 2002)

See also Also Note 14 in Table S.6.3.b. Notes for Table S.6.3.a.

S.6.6. Counting Feature, Minimum Individual Piece Weight, and Minimum Sample Piece Count. – A Class I or Class II prescription scale with an operational counting feature shall be marked with the minimum individual piece weight and minimum number of pieces used in the sample to establish an individual piece weight.

(Added 2003)

N. Notes

N.1. Test Procedures.

N.1.1. Increasing-Load Test. – The increasing-load test shall be conducted on all scales with the test loads approximately centered on the load-receiving element of the scale, except on a scale having a nominal capacity greater than the total available known test load. When the total test load is less than the nominal capacity, the test load is used to greatest advantage by concentrating it, within prescribed load limits, over the main load supports of the scale.

N.1.2. Decreasing-Load Test (Automatic Indicating Scales). – The decreasing-load test shall be conducted with the test load approximately centered on the load-receiving element of the scale.

N.1.2.1. Scales Marked I, II, III, or IIII. – Except for portable wheel load weighers, decreasing-load tests shall be conducted on scales marked I, II, III or IIII and with “n” equal to or greater than 1000 with test loads equal to the maximum test load at each tolerance value. For example, on a Class III scale, at test loads equal to 4000 d, 2000 d, and 500 d; for scales with n less than 1000, the test load shall be equal to one-half of the maximum load applied in the increasing-load test. (See Also Table 6. Maintenance Tolerances.)
(Amended 1998)

N.1.2.2. All Other Scales. – On all other scales, except for portable wheel load weighers, the decreasing-load test shall be conducted with a test load equal to one-half of the maximum load applied in the increasing-load test.
(Amended 1998)

N.1.3. Shift Test.

N.1.3.1. Dairy-Product Test Scales. – A shift test shall be conducted with a test load of 18 g successively positioned at all points on which a weight might reasonably be placed in the course of normal use of the scale.

N.1.3.2. Equal-Arm Scales. – A shift test shall be conducted with a half-capacity test load centered successively at four points positioned equidistance between the center and the front, left, back, and right edges of each pan as shown in the diagrams below. An equal test load shall be centered on the other pan.

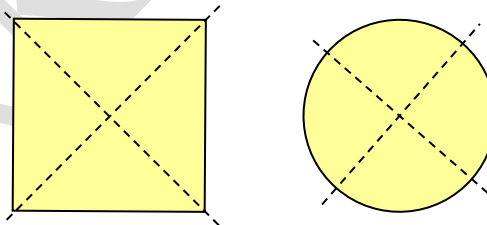

N.1.3.3. Vehicle Scales, Axle-Load Scales, and Livestock Scales.

N.1.3.3.1. Vehicle Scales, Axle-Load Scales, and Combination Vehicle/Livestock Scales.

- (a) **Minimum Shift Test.** – At least one shift test shall be conducted with a minimum test load of 12.5 % of scale capacity, which may be performed anywhere on the load-receiving element using the prescribed test patterns and maximum test loads specified below. (Combination Vehicle/Livestock Scales shall also be tested consistent with N.1.3.3.2. Prescribed Test Pattern and Test Loads for Livestock Scales with More Than Two Sections and Combination Vehicle/Livestock Scales.)

(Amended 1991, 2000, and 2003)

- (b) **Prescribed Test Pattern and Loading for Vehicle Scales, Axle-Load Scales, and Combination Vehicle/Livestock Scales.** – The normal prescribed test pattern shall be an area of 1.2 m (4 ft) in length and 3.0 m (10 ft) in width or the width of the scale platform, whichever is less. Multiple test

patterns may be utilized when loaded in accordance with paragraph (c), (d), or (e) as applicable. An example of a possible test pattern is shown in the diagram below.

(Amended 1997, 2001, and 2003)

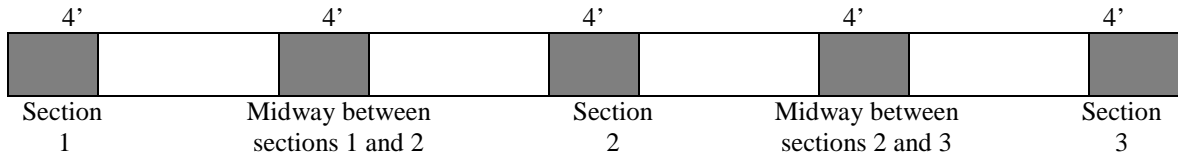

- (c) **Loading Precautions for Vehicle Scales, Axle-Load Scales, and Combination Vehicle/Livestock Scales.** – When loading the scale for testing, one side of the test pattern shall be loaded to no more than half of the concentrated load capacity or test load before loading the other side. The area covered by the test load may be less than 1.2 m (4 ft) x 3.0 m (10 ft) or the width of the scale platform, whichever is less; for test patterns less than 1.2 m (4 ft) in length the maximum loading shall meet the formula: [(wheel base of test cart or length of test load divided by 48 in) x 0.9 x CLC]. The maximum test load applied to each test pattern shall not exceed the concentrated load capacity of the scale. When the test pattern exceeds 1.2 m (4 ft), the maximum test load applied shall not exceed the concentrated load capacity times the largest “r” factor in Table UR.3.2.1. Span Maximum Load for the length of the area covered by the test load. For load-receiving elements installed prior to January 1, 1989, the rated section capacity may be substituted for concentrated load capacity to determine maximum loading. An example of a possible test pattern is shown above.

(Amended 1997 and 2003)

- (d) **Multiple Pattern Loading.** – To test to the nominal capacity, multiple patterns may be simultaneously loaded in a manner consistent with the method of use.
- (e) **Other Designs.** – Special design scales and those that are wider than 3.7 m (12 ft) shall be tested in a manner consistent with the method of use but following the principles described above.

(Amended 1988, 1991, 1997, 2000, 2001, and 2003)

(Amended 2003)

N.1.3.3.2. Prescribed Test Pattern and Test Loads for Livestock Scales with More Than Two Sections and Combination Vehicle/Livestock Scales. – A minimum test load of 5 000 kg (10 000 lb) or one-half of the rated section capacity, whichever is less, shall be placed, as nearly as possible, successively over each main load support as shown in the diagram below. For livestock scales manufactured between January 1, 1989, and January 1, 2003, the required loading shall be no greater than one-half CLC. (Two-section livestock scales shall be tested consistent with N.1.3.7. All Other Scales Except Crane Scales, Hanging Scales, Hopper Scales, Wheel-Load Weighers, and Portable Axle-Load Weighers.)

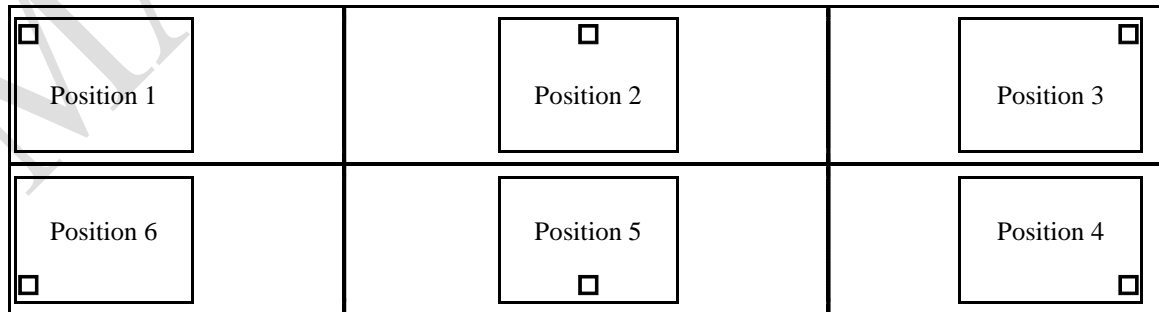

= Load Bearing Point

(Added 2003)

N.1.3.3.3. Prescribed Test Patterns and Test Loads for Two-Section Livestock Scales. – A shift test shall be conducted using the following prescribed test loads and test patterns, provided the shift test load does not exceed one-half the rated section capacity or one-half the rated concentrated load capacity whichever is applicable, using either:

- (a) A one-half nominal capacity test load centered as nearly as possible, successively at the center of each quarter of the load-receiving element as shown in N.1.3.7. All Other Scales Except Crane Scales, Hanging Scales, Hopper Scales, Wheel-Load Weighers, and Portable Axle-Load Weighers Figure 1; or
- (b) A one-quarter nominal capacity test load centered as nearly as possible, successively over each main load support as shown in N.1.3.7. All Other Scales Except Crane Scales, Hanging Scales, Hopper Scales, Wheel-Load Weighers, and Portable Axle-Load Weighers Figure 2.

(Added 2007)

N.1.3.4. Railway Track Scales Weighing Individual Cars in Single Drafts. – A shift test shall be conducted with at least two different test loads, if available, distributed over, to the right and left of, each pair of main levers or other weighing elements supporting each section of the scale.

N.1.3.5. Monorail Scales, Static Test. – A shift test shall be conducted with a test load equal to the largest load that can be anticipated to be weighed in a given installation, but never less than one-half scale capacity. The load shall be placed successively on the right end, the left end, and the center of the live rail.

(Added 1985)

N.1.3.5.1. Dynamic Monorail Weighing Systems. – Dynamic tests with livestock carcasses or portions of carcasses shall be conducted during normal plant production. No less than 20 test loads using carcasses or portions of carcasses of the type normally weighed shall be used in the dynamic test. If the plant conveyor chain does not space or prevent the carcasses or portions of carcasses from touching one another, dynamic tests shall not be conducted until this condition has been corrected.

All carcasses or portions of carcasses shall be individually weighed statically on either the same scale being tested dynamically or another monorail scale with the same or smaller divisions and in close proximity. (The scale selected for static weighing of the carcasses or portions of carcasses shall first be tested statically with certified test weights that have been properly protected from the harsh environment of the packing plant to ensure they maintain accuracy.)

If the scale being tested is used for weighing freshly slaughtered animals (often referred to as a “hot scale”), care must be taken to get a static weighment as quickly as possible before or following the dynamic weighment to avoid loss due to shrink. If multiple dynamic tests are conducted using the same carcasses or portions of carcasses, static weights shall be obtained before and after multiple dynamic tests. If the carcass or portion of a carcass changes weight between static tests, the amount of weight change shall be taken into account, or the carcass or portion of a carcass shall be disregarded for tolerance purposes.

Note: For a dynamic monorail test, the reference scale shall comply with the principles in the Fundamental Considerations paragraph 3.2. Tolerances for Standards.

(Added 1996) (Amended 1999 and 2007)

N.1.3.6. Vehicle On-Board Weighing Systems. – The shift test for a vehicle on-board weighing system shall be conducted in a manner consistent with its normal use. For systems that weigh as part of the lifting cycle, the center of gravity of the load may be shifted in the vertical direction as well as from side to side. In other cases, the center of gravity may be moved to the extremes of the load-receiving element using loads of a magnitude that reflect normal use (i.e., the load for the shift test may exceed one-half scale capacity), and may, in some cases, be equal to the capacity of the scale. The shift test may be conducted when the weighing system is out of level to the extent that the weighing system remains operational.

(Added 1992)

N.1.3.7. All Other Scales Except Crane Scales, Hanging Scales, Hopper Scales, Wheel-Load Weighers, and Portable Axle-Load Weighers. – A shift test shall be conducted using the following prescribed test loads and test patterns. A single field standard weight used as the prescribed test load shall be applied centrally in the prescribed test pattern. When multiple field standard weights are used as the prescribed test load, the load shall be applied in a consistent pattern in the shift test positions throughout the test and applied in a manner that does not concentrate the load in a test pattern that is less than when that same load is a single field standard weight on the load-receiving element.

- (a) For scales with a nominal capacity of 500 kg (1000 lb) or less, a shift test shall be conducted using a one-third nominal capacity test load (defined as test weights in amounts of at least 30 % of scale capacity, but not to exceed 35 % of scale capacity) centered as nearly as possible at the center of each quadrant of the load-receiving element using the prescribed test pattern as shown in Figure 1.
- (b) For scales with a nominal capacity greater than 500 kg (1000 lb), a shift test may be conducted by either using a one-third nominal capacity test load (defined as test weights in amounts of at least 30 % of scale capacity, but not to exceed 35 % of scale capacity) centered as nearly as possible at the center of each quadrant of the load-receiving element using the prescribed test pattern as shown in Figure 1, or by using a one-quarter nominal capacity test load centered as nearly as possible, successively, over each corner of the load-receiving element using the prescribed test pattern as shown in Figure 2.

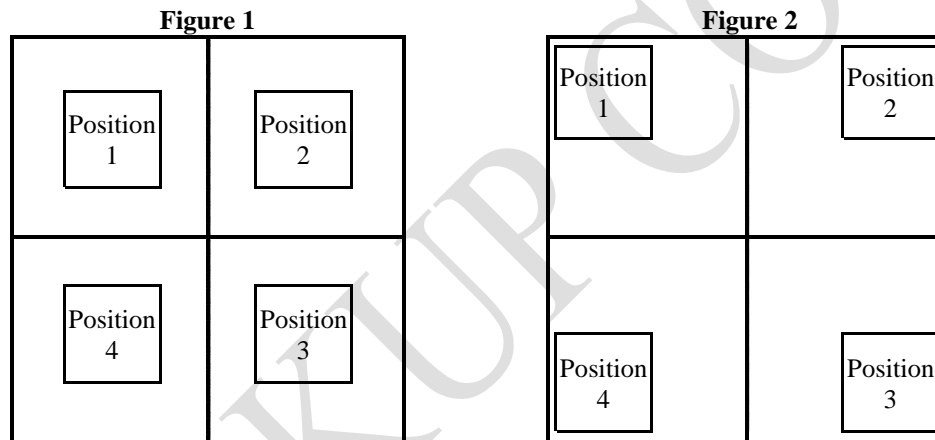

(Added 2003)

(Amended 1987, 2003, and 2007)

N.1.4. Sensitivity Test. – A sensitivity test shall be conducted on nonautomatic-indicating (weighbeam) scales only, with the weighing device in equilibrium at zero-load and at maximum test load. The test shall be conducted by increasing or decreasing the test load in an amount equal to the applicable value specified in T.2. Sensitivity Requirement (SR) or T.N.6. Sensitivity.

N.1.5. Discrimination Test. – A discrimination test shall be conducted on all automatic indicating scales with the weighing device in equilibrium at or near zero load and at or near maximum test load, and under controlled conditions in which environmental factors are reduced to the extent that they will not affect the results obtained. For scales equipped with an Automatic Zero-Tracking Mechanism (AZT), the discrimination test may be conducted at a range outside of the AZT range.

[Nonretroactive as of January 1, 1986]

(Added 1985) (Amended 2004)

N.1.5.1. Digital Device. – On a digital device, this test is conducted from just below the lower edge of the zone of uncertainty for increasing load tests, or from just above the upper edge of the zone of uncertainty for decreasing-load tests.

N.1.6. RFI Susceptibility Tests, Field Evaluation. – An RFI test shall be conducted at a given installation when the presence of RFI has been verified and characterized if those conditions are considered “usual and customary.”

(Added 1986)

N.1.7. Ratio Test. – A ratio test shall be conducted on all scales employing counterpoise weights and on nonautomatic-indicating equal-arm scales.

N.1.8. Material Tests. – A material test shall be conducted on all customer-operated bulk weighing systems for recycled materials using bulk material for which the device is used. Insert into the device, in a normal manner, several accurately pre-weighed samples (free of foreign material) in varying amounts approximating average drafts.

N.1.9. Zero-Load Balance Change. – A zero-load balance change test shall be conducted on all scales after the removal of any test load. The zero-load balance should not change by more than the minimum tolerance applicable. (See also see Also G-UR.4.2. Abnormal Performance.)

N.1.10. Counting Feature Test. – A test of the counting function shall be conducted on all Class I and Class II prescription scales having an active counting feature used in “legal for trade” applications. The test should verify that the scale will not accept a sample with less than either the minimum sample piece count or the minimum sample weight of 30 e. Counting feature accuracy should be verified at a minimum of two test loads. Verification of the count calculations shall be based upon the weight indication of the test load.

Note:

(1) The minimum sample weight is equal to the marked minimum individual piece weight times the marked minimum sample piece count.

(2) Test load as used in this section refers to actual calibration test weights selected from an appropriate test weight class.

(Added 2003)

N.1.11. Substitution Test. – In the substitution test procedure, material or objects are substituted for known test weights, or a combination of known test weights and previously quantified material or objects, using the scale under test as a comparator. Additional test weights or other known test loads may be added to the known test load to evaluate higher weight ranges on the scale.

(Added 2003)

N.1.12. Strain-Load Test. – In the strain-load test procedure, an unknown quantity of material or objects are used to establish a reference load or tare to which test weights or substitution test loads are added.

(Added 2003)

N.2. Verification (Testing) Standards. – Field standard weights used in verifying weighing devices shall comply with requirements of NIST Handbook 105-Series standards (or other suitable and designated standards) or the tolerances expressed in Fundamental Considerations, paragraph 3.2. (i.e., one-third of the smallest tolerance applied).

(Amended 1986)

N.3. Minimum Test Weights and Test Loads. – The minimum test weights and test loads for in-service tests (except railway track scales) are shown in Table 4. (See Also Footnote 2 in Table 4. Minimum Test Weights and Test Loads.)

(Added 1984) (Amended 1988)

N.3.1. Minimum Test-Weight Load and Tests for Railway Track Scales.

(Amended 1990 and 2012)

N.3.1.1. Initial and Subsequent Tests. – The test-weight load shall be not less than 35 000 kg (80 000 lb). A strain-load test conducted up to the used capacity of the weighing system is recommended.

(Added 1990) (Amended 2012)

N.3.1.2. Interim – A Test Test. – An Interim Test may be used to return a railway track scale into temporary service following repairs that could affect the accuracy of the weighing system providing all of the following conditions are met:

- (a) a test weight load of not less than 13 500 kg (30 000 lb) shall be used;
- (b) a shift (section) test shall be conducted using a test-weight load of not less than 13 500 kg (30 000 lb);
- (c) a strain-load test shall be conducted up to at least 25 % of scale capacity;
- (d) all test results shall be within applicable tolerances; and
- (e) the official with statutory authority shall be immediately notified when scales are repaired and placed in temporary service with an Interim Test. The length of temporary service following repair is at the discretion of the official with statutory authority.

(Added 1990) (Amended 2012)

N.3.1.3. Enforcement Action for Inaccuracy. – To take enforcement action on a scale that is found to be inaccurate, a minimum test load of 13 500 kg (30 000 lb) must be used.

(Added 1990)

| Table 4. Minimum Test Weights and Test Loads¹ | | | | | |
|--|---|-------------------------------|--|---|-------------------------------|
| Devices in Metric Units | | | Devices in U.S. Customary Units | | |
| Device Capacity (kg) | Minimums (in terms of device capacity) | | Device Capacity (lb) | Minimums (in terms of device capacity) | |
| | Test Weights (greater of) | Test Loads² | | Test Weights (greater of) | Test Loads² |
| 0 to 150 kg | 100 % | | 0 to 300 lb | 100 % | |
| 151 to 1 500 kg | 25 % or 150 kg | 75 % | 301 to 3 000 lb | 25 % or 300 lb | 75 % |
| 1 501 to 20 000 kg | 12.5 % or 500 kg | 50 % | 3001 to 40 000 lb | 12.5 % or 1 000 lb | 50 % |
| 20 001 kg+ | 12.5 % or 5 000 kg | 25 % ³ | 40 001 lb+ | 12.5 % or 10 000 lb | 25 % ³ |
| Where practicable: | | | | | |
| <ul style="list-style-type: none"> • Test weights to dial face capacity, 1000 d, or test load to used capacity, if greater than minimums specified. • During initial verification, a scale should be tested to capacity. | | | | | |

¹ If the amount of test weight in Table 4 combined with the load on the scale would result in an unsafe condition, then the appropriate load will be determined by the official with statutory authority.

² The term “test load” means the sum of the combination of field standard test weights and any other applied load used in the conduct of a test using substitution test methods. Not more than three substitutions shall be used during substitution testing, after which the tolerances for strain load tests shall be applied to each set of test loads.

³ The scale shall be tested from zero to at least 12.5 % of scale capacity using known test weights and then to at least 25 % of scale capacity using either a substitution or strain load test that utilizes known test weights of at least 12.5 % of scale capacity. Whenever practical, a strain load test should be conducted to the used capacity of the scale. When a strain load test is conducted, the tolerances apply only to the test weights or substitution test loads.

(Amended 1988, 1989, 1994, and 2003)

Note: GIPSA requires devices subject to their inspection to be tested to at least “used capacity,” which is calculated based on the platform area of the scale and a weight factor assigned to the species of animal weighed on the scale. “Used capacity” is calculated using the formula:

Used Scale Capacity = Scale Platform Area x Species Weight Factor

Where species weight factor = 540 kg/m² (110 lb/ft²) for cattle, 340 kg/m² (70 lb/ft²) for calves and hogs, and 240 kg/m² (50 lb/ft²) for sheep and lambs.

N.3.2. Field Standard Weight Carts. – Field Standard Weight Carts that comply with the tolerances expressed in Fundamental Considerations, paragraph 3.2. (i.e., one-third of the smallest tolerance applied) may be included as part of the minimum required test load (See Also Table 4. Minimum Test Weights and Test Loads) for shift tests and other test procedures.

(Added 2004)

N.4. Coupled-in-Motion Railroad Weighing Systems.²⁹

N.4.1. Weighing Systems Used to Weigh Trains of Less Than Ten Cars. – These weighing systems shall be tested using a consecutive-car test train consisting of the number of cars weighed in the normal operation run over the weighing system a minimum of five times in each mode of operation following the final calibration.

(Added 1990) (Amended 1992)

N.4.2. Weighing Systems Placed in Service Prior to January 1, 1991, and Used to Weigh Trains of Ten or More Cars. – The minimum test train shall be a consecutive-car test train of no less than ten cars run over the scale a minimum of five times in each mode of operation following final calibration.

(Added 1990) (Amended 1992)

N.4.3. Weighing Systems Placed in Service on or After January 1, 1991, and Used to Weigh Trains of Ten or More Cars.

(a) These weighing systems shall be tested using a consecutive-car test train of no less than ten cars run over the scale a minimum of five times in each mode of operation following final calibration; or

(b) if the official with statutory authority determines it necessary, the As-Used Test Procedures outlined in N.4.3.1. shall be used.

(Added 1990) (Amended 1992)

²⁹ A test weight car that is representative of one of the types of cars typically weighed on the scale under test may be used wherever reference weight cars are specified.

(Added 1991)

N.4.3.1. As-Used Test Procedures – A weighing system shall be tested in a manner that represents the normal method of operation and length(s) of trains normally weighed. The weighing systems may be tested using either a:

- (a) consecutive-car test train of a length typical of train(s) normally weighed; or
- (b) distributed-car test train of a length typical of train(s) normally weighed.

However, a consecutive-car test train of a shorter length may be used, provided that initial verification test results for the shorter consecutive-car test train agree with the test results for the distributed-car or full-length consecutive-car test train as specified in N.4.3.1.1. Initial Verification.

The official with statutory authority shall be responsible for determining the minimum test train length to be used on subsequent tests.

(Added 1990) (Amended 1992)

N.4.3.1.1. Initial Verification. – Initial verification tests should be performed on any new weighing system and whenever either the track structure or the operating procedure changes. If a consecutive-car test train of length shorter than trains normally weighed is to be used for subsequent verification, the shorter consecutive-car test train results shall be compared either to a distributed-car or to a consecutive-car test train of length(s) typical of train(s) normally weighed.

The difference between the total train weight of the train(s) representing the normal method of operation and the weight of the shorter consecutive-car test train shall not exceed 0.15 %. If the difference in test results exceeds 0.15 %, the length of the shorter consecutive-car test train shall be increased until agreement within 0.15 % is achieved. Any adjustments to the weighing system based upon the use of a shorter consecutive-car test train shall be offset to correct the bias that was observed between the full-length train test and the shorter consecutive-car test train.

(Added 1990) (Amended 1992 and 1993)

N.4.3.1.2. Subsequent Verification. – The test train may consist of either a consecutive-car test train with a length not less than that used in initial verification, or a distributed-car test train representing the number of cars used in the normal operation.

(Added 1990)

N.4.3.1.3. Distributed-Car Test Trains.

- (a) The length of the train shall be typical of trains that are normally weighed.
- (b) The reference weight cars shall be split into three groups, each group consisting of ten cars or 10 % of the train length, whichever is less.

(Amended 1991)

- (c) The test groups shall be placed near the front, around the middle, and near the end of the train.
- (d) Following the final adjustment, the distributed-car test train shall be run over the scale at least three times or shall produce 50 weight values, whichever is greater.

- (e) The weighing system shall be tested in each mode of operation.

(Added 1990) (Amended 1992)

N.4.3.1.4. Consecutive-Car Test Trains.

- (a) A consecutive-car test train shall consist of at least ten cars.
- (b) If the consecutive-car test train consists of between ten and twenty cars, inclusive, it shall be run over the scale a minimum of five times in each mode of operation following the final calibration.
- (c) If the consecutive-car test train consists of more than twenty cars, it shall be run over the scale a minimum of three times in each mode of operation.

(Added 1990) (Amended 1992)

N.5. Uncoupled-in-Motion Railroad Weighing System. – An uncoupled-in-motion scale shall be tested statically before being tested in motion by passing railroad reference weight cars over the scale. When an uncoupled-in-motion railroad weighing system is tested, the car speed and the direction of travel shall be the same as when the scale is in normal use. The minimum in-motion test shall be three reference weight cars passed over the scale three times. The cars shall be selected to cover the range of weights that are normally weighed on the system and to reflect the types of cars normally weighed.

(Added 1993)

N.6. Nominal Capacity of Prescription Scales. – The nominal capacity of a prescription scale shall be assumed to be one-half apothecary ounce, unless otherwise marked. (Applicable only to scales not marked with an accuracy class.)

T. Tolerances Applicable to Devices not Marked I, II, III, III L, or IIII**T.1. Tolerance Values.**

T.1.1. General. – The tolerances applicable to devices not marked with an accuracy class shall have the tolerances applied as specified in Table T.1.1. Tolerances for Unmarked Scales.

(Amended 1990)

T.1.2. Postal and Parcel Post Scales. – The tolerances for postal and parcel post scales are given in Table T.1.1. Tolerances for Unmarked Scales and Table 5. Maintenance and Acceptance Tolerances for Unmarked Postal and Parcel Post Scales.

(

| Table T.1.1. Tolerances for Unmarked Scales | | | | | | |
|---|--|---|--|--|---|--|
| Type of Device | Subcategory | Minimum Tolerance | Acceptance Tolerance | Maintenance Tolerance | Decreasing-Load Multiplier ¹ | Other Applicable Requirements |
| Vehicle, axle-load, livestock, railway track (weighing statically), crane, and hopper (other than grain hopper) | | Class III L, T.N.3.1 (Table 6) and T.N.3.2. | | | 1.0 | T.N.2., T.N.3., T.N.4.1., T.N.4.2., T.N.4.3., T.N.4.4., T.N.5., T.N.7.2., T.N.8.1.4. ⁴ , T.N.9. |
| Grain test scales | n ≤ 10 000 n > 10 000 | Class III, T.N.3.1. (Table 6) and T.N.3.2. Class II, T.N.3.1. (Table 6) and T.N.3.2. | | | 1.0 | T.N.8.1.4. ⁴ , T.N.9. |
| Railway track scales weighing in motion | | T.N.3.6. except that for T.N.3.6.2. (a), no single error shall exceed four times the maintenance tolerance. | | | 1.0 | T.N.8.1.4. ⁴ , T.N.9. |
| Monorail scales, in-motion | | T.N.3.8. | | | 1.0 | T.N.8.1.4. ⁴ , T.N.9. |
| Customer-operated bulk-weighing systems for recycled materials | | ± 5 % of applied material test load. Average error on 10 or more test loads ≤ 2.5 %. | | | 1.0 | T.N.8.1.4. ⁴ , T.N.9. |
| Wheel-load weighers and portable axle-load scales | Tested individually or in pairs ² | 0.5 d or 50 lb, whichever is greater | 1 % of test load | 2 % of test load | 1.5 ³ | T.N.8.1.4. ⁴ , T.N.9. |
| Prescription scales | | 0.1 grain (6 mg) | 0.1 % of test load | 0.1 % of test load | 1.5 | T.N.8.1.4. ⁴ , T.N.9. |
| Jewelers' scales | Graduated | 0.5 d | 0.05 % of test load | 0.05 % of test load | 1.5 | T.N.8.1.4. ⁴ , T.N.9. |
| | Ungraduated | Sensitivity or smallest weight, whichever is less | | | | |
| Dairy-product test scale | Loads < 18 g 18 g load | 0.2 grain 0.2 grain | 0.2 grain 0.3 grain | 0.2 grain 0.5 grain | 1.5 | T.N.8.1.4. ⁴ , T.N.9. |
| Postal and parcel post scales designed/used to weigh loads < 2 lb | Loads < 2 lb | 15 grain, 1 g, 1/32 oz, 0.03 oz, or 0.002 lb | 15 grain, 1 g, 1/32 oz, 0.03 oz, or 0.002 lb | 15 grain, 1 g, 1/32 oz, 0.03 oz, or 0.002 lb | 1.5 | T.N.8.1.4. ⁴ , T.N.9. |
| | Loads ≤ 2 lb | Table 5 | Table 5 | Table 5 | | |
| Other postal and parcel post scales | | Table 5 | Table 5 | Table 5 | 1.5 | T.N.8.1.4. ⁴ , T.N.9. |
| All other scales (including grain hopper) | n > 5000 | 0.5 d or 0.05 % of scale capacity, whichever is less | 0.05 % of test load | 0.1 % of test load | 1.5 | T.N.2.5., T.N.4.1., T.N.4.2., T.N.4.3., T.N.5., T.N.7.2., T.N.8.1.4. ⁴ , T.N.9. |
| | n ≤ 5000 | Class III, T.N.3.1., Table 6 and T.N.3.2. | | | 1.0 | T.N.2., T.N.3., T.N.4.1., T.N.4.2., T.N.4.3., T.N.5., T.N.7.2., T.N.8.1.4. ⁴ , T.N.9. |
| ¹ The decreasing load test applies only to automatic indicating scales. ² If marked and tested as a pair, the tolerance shall be applied to the sum of the indication. | | | ³ The decreasing load test does not apply to portable wheel load weighers. ⁴ T.N.8.1.4. Operating Temperature. is nonretroactive and effective for unmarked devices manufactured as of January 1, 1981. | | | |

(Table Added 1990; Amended 1992, 1993, and 2012)

Amended 1990)

| Table 5. Maintenance and Acceptance Tolerances for Unmarked Postal and Parcel Post Scales | | | | | |
|--|----------------------------|--------------------------------------|-------------|-------------------------------------|-------------|
| Scale Capacity (lb) | Test Loads (lb) | Maintenance Tolerance (±) | | Acceptance Tolerance (±) | |
| | | (oz) | (lb) | (oz) | (lb) |
| 0 to 4, inclusive* | 0 to 1, inclusive | 1/32 | 0.002 | 1/32 | 0.002 |
| | over 1 | 1/8 | 0.008 | 1/16 | 0.004 |
| over 4* | 0 to 7, inclusive | 3/16 | 0.012 | 3/16 | 0.012 |
| | 7+ to 24, inclusive | 3/8 | 0.024 | 3/16 | 0.012 |
| | 24+ to 30, inclusive | 1/2 | 0.030 | 1/4 | 0.015 |
| | over 30 | 0.1 % of Test Load | | 0.05 % of Test Load | |

*See Also Table T.1.1. Tolerances for Unmarked Scales for scales designed and/or used to weigh loads less than 2 lb.

T.2. Sensitivity Requirement (SR).

T.2.1. Application. – The sensitivity requirement (SR) is applicable to all nonautomatic-indicating scales not marked I, II, III, III L, or IIII, and is the same whether acceptance or maintenance tolerances apply.

T.2.2. General. – Except for scales specified in paragraphs T.2.3. Prescription Scales through T.2.8. Railway Track Scales: 2 d, 0.2 % of the scale capacity, or 40 lb, whichever is least.

T.2.3. Prescription Scales. 6 mg (0.1 grain).

T.2.4. Jewelers’ Scales.

T.2.4.1. With One-Half Ounce Capacity or Less. – 6 mg (0.1 grain).

T.2.4.2. With More Than One-Half Ounce Capacity. – 1 d or 0.05 % of the scale capacity, whichever is less.

T.2.5. Dairy-Product Test Scales.

T.2.5.1. Used in Determining Butterfat Content. – 32 mg (0.5 grain).

T.2.5.2. Used in Determining Moisture Content. – 19 mg (0.3 grain).

T.2.6. Grain Test Scales. – The sensitivity shall be as stated in T.N.6. Sensitivity. (Amended 1987)

T.2.7. Vehicle, Axle-Load, Livestock, and Animal Scales.

T.2.7.1. Equipped With Balance Indicators. – 1 d.

T.2.7.2. Not Equipped With Balance Indicators. – 2 d or 0.2 % of the scale capacity, whichever is less.

T.2.8. Railway Track Scales. – 3 d or 100 lb, whichever is less.

T.3. Sensitivity Requirement, Equilibrium Change Required.

The minimum change in equilibrium with test loads equal to the values specified in T.2. Sensitivity Requirements (SR) shall be as follows:

- (a) **Scale with a Trig Loop but without a Balance Indicator.** – The position of rest of the weighbeam shall change from the center of the trig loop to the top or bottom, as the case may be.
- (b) **Scale with a Single Balance Indicator and Having a Nominal Capacity of Less Than 250 kg (500 lb).** – The position of rest of the indicator shall change 1.0 mm (0.04 in) or one division on the graduated scale, whichever is greater.
- (c) **Scale with a Single Balance Indicator and Having a Nominal Capacity of 250 kg (500 lb) or Greater.** – The position of rest of the indicator shall change 6.4 mm (0.25 in) or one division on the graduated scale or the width of the central target area, whichever is greater. However, the indicator on a batching scale shall change 3.2 mm (0.125 in) or one division on the graduated scale, whichever is greater.
- (d) **Scale with Two Opposite-Moving Balance Indicators.** – The position of rest of the two indicators moving in opposite directions shall change 1.0 mm (0.04 in) with respect to each other.
- (e) **Scale with Neither a Trig Loop nor a Balance Indicator.** – The position of rest of the weighbeam or lever system shall change from the horizontal, or midway between limiting stops, to either limit of motion.

T.N. Tolerances Applicable to Devices Marked I, II, III, III L, and IIII.**T.N.1. Principles.**

T.N.1.1. Design. – The tolerance for a weighing device is a performance requirement independent of the design principle used.

T.N.1.2. Accuracy Classes. – Weighing devices are divided into accuracy classes according to the number of scale divisions (n) and the value of the scale division (d).

T.N.1.3. Scale Division. – The tolerance for a weighing device is related to the value of the scale division (d) or the value of the verification scale division (e) and is generally expressed in terms of d or e.

T.N.2. Tolerance Application.

T.N.2.1. General. – The tolerance values are positive (+) and negative (–) with the weighing device adjusted to zero at no load. When tare is in use, the tolerance values are applied from the tare zero reference (zero net weight indication); the tolerance values apply to the net weight indication for any possible tare load using certified test loads. (Amended 2008)

T.N.2.2. Type Evaluation Examinations. – For type evaluation examinations, the tolerance values apply to increasing and decreasing load tests within the temperature, power supply, and barometric pressure limits specified in T.N.8.

T.N.2.3. Subsequent Verification Examinations. – For subsequent verification examinations, the tolerance values apply regardless of the influence factors in effect at the time of the conduct of the examination. (See also G-N.2. Testing with Nonassociated Equipment.)

T.N.2.4. Multi-Interval and Multiple Range (Variable Division-Value) Scales. – For multi-interval and multiple range scales, the tolerance values are based on the value of the scale division of the range in use.

T.N.2.5. Ratio Tests. – For ratio tests, the tolerance values are 0.75 of the applicable tolerances.

T.N.3. Tolerance Values.

T.N.3.1. Maintenance Tolerance Values. – The maintenance tolerance values are as specified in Table 6. Maintenance Tolerances.

T.N.3.2. Acceptance Tolerance Values. – The acceptance tolerance values shall be one-half the maintenance tolerance values.

T.N.3.3. Wheel-Load Weighers and Portable Axle-Load Weighers of Class III. – The tolerance values are two times the values specified in T.N.3.1. Maintenance Tolerance Values and T.N.3.2. Acceptance Tolerance Values. (Amended 1986)

T.N.3.4. Crane and Hopper (Other than Grain Hopper) Scales. – The maintenance and acceptance tolerances shall be as specified in T.N.3.1. Maintenance Tolerance Values and T.N.3.2. Acceptance Tolerance Values for Class III L, except that the tolerance for crane and construction materials hopper scales shall not be less than 1 d or 0.1 % of the scale capacity, whichever is less. (Amended 1986)

| Table 6. Maintenance Tolerances (All values in this table are in scale divisions) | | | | |
|---|------------|------------------|---|---------|
| Tolerance in Scale Divisions | | | | |
| | 1 | 2 | 3 | 5 |
| Class | Test Load | | | |
| I | 0 - 50 000 | 50 001 - 200 000 | 200 001 + | |
| II | 0 - 5 000 | 5 001 - 20 000 | 20 001 + | |
| III | 0 - 500 | 501 - 2 000 | 2 001 - 4 000 | 4 001 + |
| IIII | 0 - 50 | 51 - 200 | 201 - 400 | 401 + |
| III L | 0 - 500 | 501 - 1 000 | (Add 1 d for each additional 500 d or fraction thereof) | |

T.N.3.5. Separate Main Elements: Load Transmitting Element, Indicating Element, Etc. – If a main element separate from a weighing device is submitted for type evaluation, the tolerance for the element is 0.7 that for the complete weighing device. This fraction includes the tolerance attributable to the testing devices used.

T.N.3.6. Coupled-In-Motion Railroad Weighing Systems. – The maintenance and acceptance tolerance values for the group of weight values appropriate to the application must satisfy the following conditions: (Amended 1990 and 1992)

T.N.3.6.1. – For any group of weight values, the difference in the sum of the individual in-motion car weights of the group as compared to the sum of the individual static weights shall not exceed 0.2 %.

(Amended 1990)

T.N.3.6.2. – If a weighing system is used to weigh trains of five or more cars, and if the individual car weights are used, any single weight value within the group must meet the following criteria:

- (a) no single error may exceed three times the static maintenance tolerance;
- (b) not more than 5 % of the errors may exceed two times the static maintenance tolerance; and
- (c) not more than 35 % of the errors may exceed the static maintenance tolerance.

(Amended 1990 and 1992)

T.N.3.6.3. – For any group of weight values wherein the sole purpose is to determine the sum of the group, T.N.3.6.1. alone applies.

(Amended 1990)

T.N.3.6.4. – For a weighing system used to weigh trains of less than five cars, no single car weight within the group may exceed the static maintenance tolerance.

(Amended 1990 and 1992)

T.N.3.7. Uncoupled-in-Motion Railroad Weighing Systems. – The maintenance and acceptance tolerance values for any single weighment within a group of non-interactive (i.e., uncoupled) loads, the weighment error shall not exceed the static maintenance tolerance.

(Amended 1992)

T.N.3.8. Dynamic Monorail Weighing System. – Acceptance tolerance shall be the same as the maintenance tolerance shown in Table 6. Maintenance Tolerances. On a dynamic test of twenty or more individual test loads, 10 % of the individual test loads may be in error, each not to exceed two times the tolerance. The error on the total of the individual test loads shall not exceed ± 0.2 %. (See also Note in N.1.3.5.1. Dynamic Monorail Weighing Systems.) *For equipment undergoing type evaluation, a tolerance equal to one-half the maintenance tolerance values shown in Table 6. Maintenance Tolerances shall apply.*

[Nonretroactive January 1, 2002]

(Added 1986) (Amended 1999 and 2001)

T.N.3.9. Materials Test on Customer-Operated Bulk Weighing Systems for Recycled Materials. – The maintenance and acceptance tolerance shall be ± 5 % of the applied materials test load except that the average error on ten or more test materials test loads shall not exceed ± 2.5 %.

(Added 1986)

T.N.3.10. Prescription Scales with a Counting Feature. – In addition to Table 6. Maintenance Tolerances (for weight), the indicated piece count value computed by a Class I or Class II prescription scale counting feature shall comply with the tolerances in Table T.N.3.10. Maintenance and Acceptance Tolerances in Excess and in Deficiency for Count.

| Table T.N.3.10. Maintenance and Acceptance Tolerances in Excess and in Deficiency for Count | |
|--|------------------------------------|
| Indication of Count | Tolerance (piece count) |
| 0 to 100 | 0 |
| 101 to 200 | 1 |
| 201 or more | 0.5 % |

(Added 2003)

T.N.3.11. Tolerances for Substitution Test. – Tolerances are applied to the scale based on the substitution test load.

(Added 2003)

T.N.3.12. Tolerances for Strain-Load Test. – Tolerances apply only to the test weights or substitution test loads.

(Added 2003)

T.N.4. Agreement of Indications.

T.N.4.1. Multiple Indicating/Recording Elements. – In the case of a scale or weighing system equipped with more than one indicating element or indicating element and recording element combination, where the indicators or indicator/recorder combination are intended to be used independently of one another, tolerances shall be applied independently to each indicator or indicator/recorder combination.

(Amended 1986)

T.N.4.2. Single Indicating/Recording Element. – In the case of a scale or weighing system with a single indicating element or an indicating/recording element combination, and equipped with component parts such as unit weights, weighbeam and weights, or multiple weighbeams that can be used in combination to indicate a weight, the difference in the weight value indications of any load shall not be greater than the absolute value of the applicable tolerance for that load, and shall be within tolerance limits.

(Amended 1986)

T.N.4.3. Single Indicating Element/Multiple Indications. – In the case of an analog indicating element equipped with two or more indicating means within the same element, the difference in the weight indications for any load other than zero shall not be greater than one-half the value of the scale division (d) and be within tolerance limits.

(Amended 1986)

T.N.4.4. Shift or Section Tests. – The range of the results obtained during the conduct of a shift test or a section test shall not exceed the absolute value of the maintenance tolerance applicable and each test result shall be within applicable tolerances.

(Added 1986)

T.N.4.5. Time Dependence. – A time dependence test shall be conducted during type evaluation and may be conducted during field verification, provided test conditions remain constant.

(Amended 1989 and 2005)

T.N.4.5.1. Time Dependence: Class II, III, and IIII Non-automatic Weighing Instruments. – A non-automatic weighing instrument of Classes II, III, and IIII shall meet the following requirements at constant test conditions. During type evaluation, this test shall be conducted at $20\text{ }^{\circ}\text{C} \pm 2\text{ }^{\circ}\text{C}$ ($68\text{ }^{\circ}\text{F} \pm 4\text{ }^{\circ}\text{F}$):

- (a) When any load is kept on an instrument, the difference between the indication obtained immediately after placing the load and the indication observed during the following 30 minutes shall not exceed 0.5 e. However, the difference between the indication obtained at 15 minutes and the indication obtained at 30 minutes shall not exceed 0.2 e.
- (b) If the conditions in (a) are not met, the difference between the indication obtained immediately after placing the load on the instrument and the indication observed during the following 4 hours shall not exceed the absolute value of the maximum permissible error at the load applied.

(Added 2005) (Amended 2006 and 2010)

T.N.4.5.2. Time Dependence: Class III L Non-automatic Weighing Instruments. – A non-automatic weighing instrument of Class III L shall meet the following requirements:

- (a) When any load is kept on an instrument, the difference between the indication obtained immediately after placing the load and the indication observed during the following 30 minutes shall not exceed 1.5 e. However, the difference between the indication obtained at 15 minutes and the indication obtained at 30 minutes shall not exceed 0.6 e.
- (b) If the conditions in (a) are not met, the difference between the indication obtained immediately after placing the load on the instrument and the indication observed during the following 4 hours shall not exceed the absolute value of the maximum permissible error at the load applied.

(Added 2005) (Amended 2010)

T.N.4.5.3. Zero Load Return: Non-automatic Weighing Instruments. – A non-automatic weighing instrument shall meet the following requirements at constant test conditions. During type evaluation, this test shall be conducted at $20\text{ }^{\circ}\text{C} \pm 2\text{ }^{\circ}\text{C}$ ($68\text{ }^{\circ}\text{F} \pm 4\text{ }^{\circ}\text{F}$). The deviation on returning to zero as soon as the indication has stabilized, after the removal of any load which has remained on the instrument for 30 minutes shall not exceed:

- (a) $0.5 e$ for Class II and III devices,
- (b) $0.5 e$ for Class III devices with 4000 or fewer divisions,
- (c) $0.83 e$ for Class III devices with more than 4000 divisions, or
- (d) one-half of the absolute value of the applicable tolerance for the applied load for Class III L devices.

For a multi-interval instrument, the deviation shall not exceed $0.83 e_1$ (where e_1 is the interval of the first weighing segment of the scale).

On a multiple range instrument, the deviation on returning to zero from Max_1 (load in the applicable weighing range) shall not exceed $0.83 e_1$ (interval of the weighing range). Furthermore, after returning to zero from any load greater than Max_1 (capacity of the first weighing range) and immediately after switching to the lowest weighing range, the indication near zero shall not vary by more than e_1 (interval of the first weighing range) during the following five minutes.

(Added 2010)

T.N.4.6. Time Dependence (Creep) for Load Cells during Type Evaluation. – A load cell (force transducer) marked with an accuracy class shall meet the following requirements at constant test conditions:

- (a) **Permissible Variations of Readings.** – With a constant maximum load for the measuring range (D_{max}) between 90 % and 100 % of maximum capacity (E_{max}), applied to the load cell, the difference between the initial reading and any reading obtained during the next 30 minutes shall not exceed the absolute value of the maximum permissible error (mpe) for the applied load (~~see~~ (Also Table T.N.4.6. Maximum Permissible Error (mpe) for Load Cells During Type Evaluation)~~).~~ The difference between the reading obtained at 20 minutes and the reading obtained at 30 minutes shall not exceed 0.15 times the absolute value of the mpe. (see ~~Also~~ Table T.N.4.6. Maximum Permissible Error (mpe) for Load Cells During Type Evaluation~~).~~
- (b) **Apportionment Factors.** – The mpe for creep shall be determined from Table T.N.4.6. Maximum Permissible Error (mpe) for Load Cells During Type Evaluation using the following apportionment factors (p_{LC}):

- $p_{\text{LC}} = 0.7$ for load cells marked with S (single load cell applications),
- $p_{\text{LC}} = 1.0$ for load cells marked with M (multiple load cell applications), and
- $p_{\text{LC}} = 0.5$ for Class III L load cells marked with S or M.

(Added 2005, Amended 2006)

| Table T.N.4.6. | | | |
|---|-------------------------------|-------------------------------|---|
| Maximum Permissible Error (mpe)* for Load Cells During Type Evaluation | | | |
| mpe in Load Cell Verifications Divisions (v) = p_{LC} x Basic Tolerance in v | | | |
| Class | p_{LC} x 0.5 v | p_{LC} x 1.0 v | p_{LC} x 1.5 v |
| I | 0 - 50 000 v | 50 001 v - 200 000 v | 200 001 v + |
| II | 0 - 5 000 v | 5 001 v - 20 000 v | 20 001 v + |
| III | 0 - 500 v | 501 v - 2 000 v | 2 001 v + |
| IIII | 0 - 50 v | 51 v - 200 v | 201 v + |
| III L | 0 - 500 v | 501 v - 1 000 v | (Add 0.5 v to the basic tolerance for each additional 500 v or fraction thereof up to a maximum load of 10 000 v) |

v represents the load cell verification interval
 p_{LC} represents the apportionment factors applied to the basic tolerance
 p_{LC} = 0.7 for load cells marked with S (single load cell applications)
 p_{LC} = 1.0 for load cells marked with M (multiple load cell applications)
 p_{LC} = 0.5 for Class III L load cells marked with S or M
 * mpe = p_{LC} x Basic Tolerance in load cell verifications divisions (v)

(Table Added 2005) (Amended 2006)

T.N.4.7. Creep Recovery for Load Cells During Type Evaluation. – The difference between the initial reading of the minimum load of the measuring range (D_{min}) and the reading after returning to minimum load subsequent to the maximum load (D_{max}) having been applied for 30 minutes shall not exceed:

- (a) 0.5 times the value of the load cell verification interval (0.5 v) for Class II and IIII load cells;
- (b) 0.5 times the value of the load cell verification interval (0.5 v) for Class III load cells with 4000 or fewer divisions;
- (c) 0.83 times the value of the load cell verification interval (0.83 v) for Class III load cells with more than 4000 divisions; or
- (d) 2.5 times the value of the load cell verification interval (2.5 v) for Class III L load cells.

(Added 2006) (Amended 2009 and 2011)

T.N.5. Repeatability. – The results obtained from several weighings of the same load under reasonably static test conditions shall agree within the absolute value of the maintenance tolerance for that load, and shall be within applicable tolerances.

T.N.6. Sensitivity. – This section is applicable to all nonautomatic-indicating scales marked I, II, III, III L, or IIII.

T.N.6.1. Test Load.

- (a) The test load for sensitivity for nonautomatic-indicating vehicle, axle-load, livestock, and animal scales shall be 1 d for scales equipped with balance indicator, and 2 d or 0.2 % of the scale capacity, whichever is less, for scales not equipped with balance indicators.
- (b) For all other nonautomatic-indicating scales, the test load for sensitivity shall be 1 d at zero and 2 d at maximum test load.

T.N.6.2. Minimum Change of Indications. – The addition or removal of the test load for sensitivity shall cause a minimum permanent change as follows:

- (a) for a scale with trig loop but without a balance indicator, the position of the weighbeam shall change from the center to the outer limit of the trig loop;
- (b) for a scale with balance indicator, the position of the indicator shall change one division on the graduated scale, the width of the central target area, or the applicable value as shown below, whichever is greater:

Scale of Class I or II: 1 mm (0.04 in),

Scale of Class III or III L with a maximum capacity of 30 kg (70 lb) or less: 2 mm (0.08 in),

Scale of Class III, III L, or III with a maximum capacity of more than 30 kg (70 lb): 5 mm (0.20 in);

- (c) for a scale without a trig loop or balance indicator, the position of rest of the weighbeam or lever system shall change from the horizontal or midway between limiting stops to either limit of motion.

(Amended 1987)

T.N.7. Discrimination.

T.N.7.1. Analog Automatic Indicating (i.e., Weighing Device with Dial, Drum, Fan, etc.). – A test load equivalent to 1.4 d shall cause a change in the indication of at least 1.0 d. (See Also N.1.5. Discrimination Test.)

T.N.7.2. Digital Automatic Indicating. – A test load equivalent to 1.4 d shall cause a change in the indicated or recorded value of at least 2.0 d. This requires the zone of uncertainty to be not greater than three-tenths of the value of the scale division. (See Also N.1.5.1. Digital Device.)

T.N.8. Influence Factors. – The following factors are applicable to tests conducted under controlled conditions only, provided that:

- (a) types of devices approved prior to January 1, 1986, and manufactured prior to January 1, 1988, need not meet the requirements of this section;
- (b) new types of devices submitted for approval after January 1, 1986, shall comply with the requirements of this section; and
- (c) all devices manufactured after January 1, 1988, shall comply with the requirements of this section.

(Amended 1985)

T.N.8.1. Temperature. – Devices shall satisfy the tolerance requirements under the following temperature conditions:

T.N.8.1.1. If not specified in the operating instructions for Class I or II scales, or if not marked on the device for Class III, III L, or III scales, the temperature limits shall be: – 10 °C to 40 °C (14 °F to 104 °F).

T.N.8.1.2. If temperature limits are specified for the device, the range shall be at least that specified in Table T.N.8.1.2. Temperature Range by Class.

| Table T.N.8.1.2. Temperature Range by Class | |
|--|--------------------------|
| Class | Temperature Range |
| I | 5 °C (9 °F) |
| II | 15 °C (27 °F) |
| III, III L, and III | 30 °C (54 °F) |

T.N.8.1.3. Temperature Effect on Zero-Load Balance. – The zero-load indication shall not vary by more than:

- (a) three divisions per 5 °C (9 °F) change in temperature for Class III L devices; or
- (b) one division per 5 °C (9 °F) change in temperature for all other devices.

(Amended 1990)

T.N.8.1.4. Operating Temperature. – Except for Class I and II devices, an indicating or recording element shall not display nor record any usable values until the operating temperature necessary for accurate weighing and a stable zero balance condition have been attained.

T.N.8.2. Barometric Pressure. – Except for Class I scales, the zero indication shall not vary by more than one scale division for a change in barometric pressure of 1 kPa over the total barometric pressure range of 95 kPa to 105 kPa (28 in to 31 in of Hg).

T.N.8.3. Electric Power Supply.

T.N.8.3.1. Power Supply, Voltage and Frequency.

- (a) Weighing devices that operate using alternating current must perform within the conditions defined in paragraphs T.N.3. Tolerance Values through T.N.7. Discrimination, inclusive, when tested over the range of – 15 % to + 10 % of the marked nominal line voltage(s) at 60 Hz, or the voltage range marked by the manufacturer, at 60 Hz.

(Amended 2003)

- (b) Battery operated instruments shall not indicate nor record values outside the applicable tolerance limits when battery power output is excessive or deficient.

T.N.8.3.2. Power Interruption. – A power interruption shall not cause an indicating or recording element to display or record any values outside the applicable tolerance limits.

T.N.9. Radio Frequency Interference (RFI) and Other Electromagnetic Interference Susceptibility. – The difference between the weight indication due to the disturbance and the weight indication without the disturbance shall not exceed one scale division (d); or the equipment shall:

- (a) blank the indication; or
- (b) provide an error message; or
- (c) the indication shall be so completely unstable that it cannot be interpreted, or transmitted into memory or to a recording element, as a correct measurement value.

The tolerance in T.N.9. Radio Frequency Interference (RFI) and Other Electromagnetic Interference Susceptibility is to be applied independently of other tolerances. For example, if indications are at allowable basic tolerance error limits when the disturbance occurs, then it is acceptable for the indication to exceed the applicable basic tolerances during the disturbance.

(Amended 1997)

UR. User Requirements

UR.1. Selection Requirements. – Equipment shall be suitable for the service in which it is used with respect to elements of its design, including but not limited to, its capacity, number of scale divisions, value of the scale division or verification scale division, minimum capacity, and computing capability.³⁰

UR.1.1. General.

- (a) For devices marked with a class designation, the typical class or type of device for particular weighing applications is shown in Table 7a. Typical Class or Type of Device for Weighing Applications.
- (b) For devices not marked with a class designation, Table 7b. Applicable to Devices not Marked with a Class Designation applies.

| Table 7a. Typical Class or Type of Device for Weighing Applications | |
|--|---|
| Class | Weighing Application or Scale Type |
| I | Precision laboratory weighing |
| II | Laboratory weighing, precious metals and gem weighing, grain test scales |
| III | All commercial weighing not otherwise specified, grain test scales, retail precious metals and semi-precious gem weighing, grain-hopper scales, animal scales, postal scales, vehicle on-board weighing systems with a capacity less than or equal to 30 000 lb, and scales used to determine laundry charges |
| III L | Vehicle scales, vehicle on-board weighing systems with a capacity greater than 30 000 lb, axle-load scales, livestock scales, railway track scales, crane scales, and hopper (other than grain hopper) scales |
| III | Wheel-load weighers and portable axle-load weighers used for highway weight enforcement |

Note: A scale with a higher accuracy class than that specified as “typical” may be used.

(Amended 1985, 1986, 1987, 1988, 1992, 1995, and 2012)

³⁰ Purchasers and users of scales such as railway track, hopper, and vehicle scales should be aware of possible additional requirements for the design and installation of such devices.

(Footnote Added 1995)

| Table 7b. Applicable to Devices not Marked with a Class Designation | |
|---|--|
| Scale Type or Design | Maximum Value of d |
| Retail Food Scales, 50 lb capacity and less | 1 oz |
| Animal Scales | 1 lb |
| Grain Hopper Scales Capacity up to and including 50 000 lb Capacity over 50 000 lb | 10 lb (not greater than 0.05 % of capacity) 20 lb |
| Crane Scales | not greater than 0.2 % of capacity |
| Vehicle and Axle-Load Scales Used in Combination Capacity up to and including 200 000 lb Capacity over 200 000 lb | 20 lb 50 lb |
| Railway Track Scales With weighbeam Automatic indicating | 20 lb 100 lb |
| Scales with capacities greater than 500 lb except otherwise specified | 0.1 % capacity (but not greater than 50 lb) |
| Wheel-Load Weighers | 0.25 % capacity (but not greater than 50 lb) |
| Note: For scales not specified in this table, G-UR.1.1. and UR.1. apply. | |

(Added 1985) (Amended 1989)

UR.1.2. Grain Hopper Scales. – Hopper scales manufactured as of January 1, 1986, that are used to weigh grain shall be Class III and have a minimum of 2000 scale divisions.

(Amended 2012)

UR.1.3. Value of the Indicated and Recorded Scale Division. – *The value of the scale division as recorded shall be the same as the division value indicated.*

[Nonretroactive as of January 1, 1986]

(Added 1985) (Amended 1999)

UR.1.3.1. Exceptions. – The provisions of UR.1.3. Value of the Indicated and Recorded Scale Division shall not apply to:

- (a) Class I scales, or
- (b) Dynamic monorail weighing systems when the value of d is less than the value of e.

(Added 1999)

UR.1.4. Grain-Test Scales: Value of the Scale Divisions. – The scale division for grain-test scales shall not exceed 0.2 g for loads through 500 g, and shall not exceed 1 g for loads above 500 g through 1000 g.

(Added 1992)

UR.1.5. Recording Element, Class III L Railway Track Scales. – *Class III L Railway Track Scales must be equipped with a recording element.*

[Nonretroactive as of January 1, 1996]

(Added 1995)

UR.2. Installation Requirements.

UR.2.1. Supports. – A scale that is portable and that is being used on a counter, table, or the floor shall be so positioned that it is firmly and securely supported.

UR.2.2. Suspension of Hanging Scale. – A hanging scale shall be freely suspended from a fixed support when in use.

UR.2.3. Protection From Environmental Factors. – The indicating elements, the lever system or load cells, and the load-receiving element of a permanently installed scale, and the indicating elements of a scale not intended to be permanently installed, shall be adequately protected from environmental factors such as wind, weather, and RFI that may adversely affect the operation or performance of the device.

UR.2.4. Foundation, Supports, and Clearance. – The foundation and supports of any scale installed in a fixed location shall be such as to provide strength, rigidity, and permanence of all components, and clearance shall be provided around all live parts to the extent that no contacts may result when the load-receiving element is empty, nor throughout the weighing range of the scale. *On vehicle and livestock scales, the clearance between the load-receiving elements and the coping at the bottom edge of the platform shall be greater than at the top edge of the platform.**

*[*Nonretroactive as of January 1, 1973]*

UR.2.5. Access to Weighing Elements. – Adequate provision shall be made for ready access to the pit of a vehicle, livestock, animal, axle-load, or railway track scale for the purpose of inspection and maintenance. Any of these scales without a pit shall be installed with adequate means for inspection and maintenance of the weighing elements.

(Amended 1985)

UR.2.6. Approaches.

UR.2.6.1. Vehicle Scales. – *On the entrance and exit end(s) of a vehicle scale, there shall be a straight approach as follows:*

- (a) the width at least the width of the platform,*
- (b) the length at least one-half the length of the platform but not required to be more than 12 m (40 ft), and*
- (c) not less than 3 m (10 ft) of any approach adjacent to the platform shall be in the same plane as the platform. Any slope in the remaining portion of the approach shall ensure (1) ease of vehicle access, (2) ease for testing purposes, and (3) drainage away from the scale.*

In addition to (a), (b), and (c), scales installed in any one location for a period of six months or more shall have not less than 3 m (10 ft) of any approach adjacent to the platform constructed of concrete or similar durable material to ensure that this portion remains smooth and level and in the same plane as the platform; however, grating of sufficient strength to withstand all loads equal to the concentrated load capacity of the scale may be installed in this portion.

[Nonretroactive as of January 1, 1976]

(Amended 1977, 1983, 1993, 2006, and 2010)

UR.2.6.2. Axle-Load Scales. – At each end of an axle-load scale there shall be a straight paved approach in the same plane as the platform. The approaches shall be the same width as the platform and of sufficient length to insure the level positioning of vehicles during weight determinations.

UR.2.7. Stock Racks. – A livestock or animal scale shall be equipped with a suitable stock rack, with gates as required, which shall be securely mounted on the scale platform. Adequate clearances shall be maintained around the outside of the rack.

UR.2.8. Hoists. – On vehicle scales equipped with means for raising the load-receiving element from the weighing element for vehicle unloading, means shall be provided so that it is readily apparent to the scale operator when the load-receiving element is in its designed weighing position.

UR.2.9. Provision for Testing Dynamic Monorail Weighing Systems. – Provisions shall be made at the time of installation of a dynamic monorail weighing systems for testing in accordance with N.1.3.5.1. *Dynamic Monorail Weighing Systems (a rail around or other means for returning the test carcasses to the scale being tested).* [Nonretroactive as of January 1, 1998]

(Added 1997) (Amended 1999)

UR.3. Use Requirements.

UR.3.1. Recommended Minimum Load. – A recommended minimum load is specified in Table 8 since the use of a device to weigh light loads is likely to result in relatively large errors.

| Table 8. Recommended Minimum Load | | |
|--|--|---|
| Class | Value of Scale Division (d or e*) | Recommended Minimum Load (d or e*) |
| I | equal to or greater than 0.001 g | 100 |
| II | 0.001 g to 0.05 g, inclusive | 20 |
| III | equal to or greater than 0.1 g | 50 |
| III | All** | 20 |
| III L | All | 50 |
| III | All | 10 |

*For Class I and II devices equipped with auxiliary reading means (i.e., a rider, a vernier, or a least significant decimal differentiated by size, shape or color), the value of the verification scale division “e” is the value of the scale division immediately preceding the auxiliary means. For Class III and III devices the value of “e” is specified by the manufacturer as marked on the device; “e” must be less than or equal to “d.”

**A minimum load of 10 d is recommended for a weight classifier marked in accordance with a statement identifying its use for special applications.

(Amended 1990)

UR.3.1.1. Minimum Load, Grain Dockage Determination. – When determining the quantity of foreign material (dockage) in grain, the weight of the sample shall be equal to or greater than 500 scale divisions.

(Added 1985)

UR.3.2. Maximum Load. – A scale shall not be used to weigh a load of more than the nominal capacity of the scale.

UR.3.2.1. Maximum Loading for Vehicle Scales. – A vehicle scale shall not be used to weigh loads exceeding the maximum load capacity of its span as specified in Table UR.3.2.1. Span Maximum Load.

(Added 1996)

| Table UR.3.2.1. Span Maximum Load | | | | | | | | | | |
|--|---|---------|---|---------|---------|---------|---------|---------|-------|-------|
| Distance in Feet Between the Extremes of any Two or More Consecutive Axles | Ratio of CLC to Maximum Load ("r" factor) Carried on Any Group of Two or More Consecutive Axles. | | | | | | | | | |
| | 2 axles | 3 axles | 4 axles | 5 axles | 6 axles | 7 axles | 8 axles | 9 axles | | |
| 4 ¹ | 1.000 | | INSTRUCTIONS: 1. Determine the scale's CLC. 2. Count the number of axles on the vehicle in a given span and determine the distance in feet between the first and last axle in the span. 3. Multiply the CLC by the corresponding multiplier in the table.* 4. The resulting number is the scale's maximum concentrated load for a single span based on the vehicle configuration. *See note and formula on next page. | | | | | | | |
| 5 ¹ | 1.000 | | | | | | | | | |
| 6 ¹ | 1.000 | | | | | | | | | |
| 7 ¹ | 1.000 | | | | | | | | | |
| 8 and less ¹ | 1.000 | 1.000 | | | | | | | | |
| More than 8 ¹ | 1.118 | 1.235 | | | | | | | | |
| 9 | 1.147 | 1.257 | | | | | | | | |
| 10 | 1.176 | 1.279 | | | | | | | | |
| 11 | 1.206 | 1.301 | | | | | | | | |
| 12 | 1.235 | 1.324 | | | | | | | 1.471 | 1.632 |
| 13 | 1.265 | 1.346 | | | | | | | 1.490 | 1.651 |
| 14 | 1.294 | 1.368 | 1.510 | 1.669 | | | | | | |
| 15 | 1.324 | 1.390 | 1.529 | 1.688 | 1.853 | | | | | |
| 16 | 1.353 | 1.412 | 1.549 | 1.706 | 1.871 | | | | | |
| 17 | 1.382 | 1.434 | 1.569 | 1.724 | 1.888 | | | | | |
| 18 | 1.412 | 1.456 | 1.588 | 1.743 | 1.906 | | | | | |
| 19 | 1.441 | 1.478 | 1.608 | 1.761 | 1.924 | | | | | |
| 20 | 1.471 | 1.500 | 1.627 | 1.779 | 1.941 | | | | | |
| 21 | 1.500 | 1.522 | 1.647 | 1.798 | 1.959 | | | | | |
| 22 | 1.529 | 1.544 | 1.667 | 1.816 | 1.976 | | | | | |
| 23 | 1.559 | 1.566 | 1.686 | 1.835 | 1.994 | | | | | |
| 24 | 1.588 | 1.588 | 1.706 | 1.853 | 2.012 | 2.176 | | | | |
| 25 | 1.618 | 1.610 | 1.725 | 1.871 | 2.029 | 2.194 | | | | |
| 26 | | 1.632 | 1.745 | 1.890 | 2.047 | 2.211 | | | | |
| 27 | | 1.654 | 1.765 | 1.908 | 2.065 | 2.228 | | | | |
| 28 | | 1.676 | 1.784 | 1.926 | 2.082 | 2.245 | 2.412 | | | |
| 29 | | 1.699 | 1.804 | 1.945 | 2.100 | 2.262 | 2.429 | | | |
| 30 | | 1.721 | 1.824 | 1.963 | 2.118 | 2.279 | 2.445 | | | |
| 31 | | 1.743 | 1.843 | 1.982 | 2.135 | 2.297 | 2.462 | | | |
| 32 | | 1.765 | 1.863 | 2.000 | 2.153 | 2.314 | 2.479 | 2.647 | | |
| 33 | | | 1.882 | 2.018 | 2.171 | 2.331 | 2.496 | 2.664 | | |
| 34 | | | 1.902 | 2.037 | 2.188 | 2.348 | 2.513 | 2.680 | | |
| 35 | | | 1.922 | 2.055 | 2.206 | 2.365 | 2.529 | 2.697 | | |
| 36 | | | 2.000 ² | 2.074 | 2.224 | 2.382 | 2.546 | 2.713 | | |
| 37 | | | 2.000 ² | 2.092 | 2.241 | 2.400 | 2.563 | 2.730 | | |
| 38 | | | 2.000 ² | 2.110 | 2.259 | 2.417 | 2.580 | 2.746 | | |
| 39 | | | 2.000 | 2.129 | 2.276 | 2.434 | 2.597 | 2.763 | | |
| 40 | | | 2.020 | 2.147 | 2.294 | 2.451 | 2.613 | 2.779 | | |
| 41 | | | 2.039 | 2.165 | 2.312 | 2.468 | 2.630 | 2.796 | | |
| 42 | | | 2.059 | 2.184 | 2.329 | 2.485 | 2.647 | 2.813 | | |
| 43 | | | 2.078 | 2.202 | 2.347 | 2.502 | 2.664 | 2.829 | | |
| 44 | | | 2.098 | 2.221 | 2.365 | 2.520 | 2.681 | 2.846 | | |
| 45 | | | 2.118 | 2.239 | 2.382 | 2.537 | 2.697 | 2.862 | | |
| 46 | | | 2.137 | 2.257 | 2.400 | 2.554 | 2.714 | 2.879 | | |
| 47 | | | 2.157 | 2.276 | 2.418 | 2.571 | 2.731 | 2.895 | | |
| 48 | | | 2.176 | 2.294 | 2.435 | 2.588 | 2.748 | 2.912 | | |
| 49 | | | 2.196 | 2.313 | 2.453 | 2.605 | 2.765 | 2.928 | | |
| 50 | | | 2.216 | 2.331 | 2.471 | 2.623 | 2.782 | 2.945 | | |

| Table UR.3.2.1. Span Maximum Load | | | | | | | | |
|---|---|----------------|--------------------|----------------|----------------|----------------|----------------|----------------|
| Distance in Feet Between the Extremes of any Two or More Consecutive Axles | Ratio of CLC to Maximum Load (“r” factor) Carried on Any Group of Two or More Consecutive Axles. | | | | | | | |
| | 2 axles | 3 axles | 4 axles | 5 axles | 6 axles | 7 axles | 8 axles | 9 axles |
| 51 | | | 2.235 | 2.349 | 2.488 | 2.640 | 2.798 | 2.961 |
| 52 | | | 2.255 | 2.368 | 2.506 | 2.657 | 2.815 | 2.978 |
| 53 | | | 2.275 | 2.386 | 2.524 | 2.674 | 2.832 | 2.994 |
| 54 | | | 2.294 | 2.404 | 2.541 | 2.691 | 2.849 | 3.011 |
| 55 | | | 2.314 | 2.423 | 2.559 | 2.708 | 2.866 | 3.028 |
| 56 | | | 2.333 | 2.441 | 2.576 | 2.725 | 2.882 | 3.044 |
| 57 | | | 2.353 ³ | 2.460 | 2.594 | 2.742 | 2.899 | 3.061 |
| 58 | | | | 2.478 | 2.612 | 2.760 | 2.916 | 3.077 |
| 59 | | | | 2.496 | 2.629 | 2.777 | 2.933 | 3.094 |
| 60 | | | | 2.515 | 2.647 | 2.794 | 2.950 | 3.110 |

***Note:** This table was developed based upon the following formula. Values may be rounded in some cases for ease of use.

$$W = r \times 500 \left[\left(\frac{LN}{N-1} \right) + 12N + 36 \right]$$

¹ Tandem Axle Weight.
² Exception – These values in the third column correspond to the maximum loads in which the inner bridge dimensions of 36, 37, and 38 ft are considered to be equivalent to 39 ft. This allows a weight of 68 000 lb on axles 2 through 5.
³ Corresponds to the Interstate Gross Weight Limit.

UR.3.3. Single-Draft Vehicle Weighing. – A vehicle or a coupled-vehicle combination shall be commercially weighed on a vehicle scale only as a single draft. That is, the total weight of such a vehicle or combination shall not be determined by adding together the results obtained by separately and not simultaneously weighing each end of such vehicle or individual elements of such coupled combination. However, the weight of a:

- (a) a coupled combination may be determined by uncoupling the various elements (tractor, semitrailer, trailer), weighing each unit separately as a single draft, and adding together the results; or
- (b) a vehicle or coupled-vehicle combination may be determined by adding together the weights obtained while all individual elements are resting simultaneously on more than one scale platform.

Note: This paragraph does not apply to highway-law-enforcement scales and scales used for the collection of statistical data. (Added 1992)

UR.3.4. Wheel-Load Weighing.

UR.3.4.1. Use in Pairs. – When wheel-load weighers or portable axle-load weighers are to be regularly used in pairs, both weighers of each such pair shall be appropriately marked to identify them as weighers intended to be used in combination.

UR.3.4.2. Level Condition. – A vehicle of which either an axle-load determination or a gross-load determination is being made utilizing wheel-load weighers or portable axle-load weighers, shall be in a reasonably level position at the time of such determination.

UR.3.5. Special Designs. – A scale designed and marked for a special application (such as a prepackaging scale or prescription scale with a counting feature) shall not be used for other than its intended purpose³¹.

(Amended 2003)

UR.3.6. Wet Commodities. – Wet commodities not in watertight containers shall be weighed only on a scale having a pan or platform that will drain properly.

(Amended 1988)

UR.3.7. Minimum Load on a Vehicle Scale. – A vehicle scale shall not be used to weigh net loads smaller than:

- (a) 10 d when weighing scrap material for recycling or weighing refuse materials at landfills and transfer stations; and
- (b) 50 d for all other weighing.

As used in this paragraph, scrap materials for recycling shall be limited to ferrous metals, paper (including cardboard), textiles, plastic, and glass.

(Amended 1988, 1992, and 2006)

UR.3.8. Minimum Load for Weighing Livestock. – A scale with scale divisions greater than 2 kg (5 lb) shall not be used for weighing net loads smaller than 500 d.

(Amended 1989)

UR.3.9. Use of Manual Weight Entries. – Manual gross or net weight entries are permitted for use in the following applications only when:

- (a) a point-of-sale system interfaced with a scale is giving credit for a weighed item;
- (b) an item is pre-weighed on a legal for trade scale and marked with the correct net weight;
- (c) a device or system is generating labels for standard weight packages;
- (d) postal scales or weight classifiers are generating manifests for packages to be picked up at a later time; or
- (e) livestock and vehicle scale systems generate weight tickets to correct erroneous tickets.

(Added 1992) (Amended 2000 and 2004)

UR.3.10. Dynamic Monorail Weighing Systems. – When the value of d is different from the value of e, the commercial transaction must be based on e.

(Added 1999)

³¹ Prepackaging scales and prescription scales with a counting feature (and other commercial devices) used for putting up packages in advance of sale are acceptable for use in commerce only if all appropriate provisions of Handbook 44 are met. Users of such devices must be alert to the legal requirements relating to the declaration of quantity on a package. Such requirements are to the effect that, on the average, the contents of the individual packages of a particular commodity comprising a lot, shipment, or delivery must contain at least the quantity declared on the label. The fact that a prepackaging scale may overregister, but within established tolerances, and is approved for commercial service is not a legal justification for packages to contain, on the average, less than the labeled quantity.

(Amended 2003)

UR.3.11. Minimum Count. – A prescription scale with an operational counting feature shall not be used to count a quantity of less than 30 pieces weighing a minimum of 90 e.

(Added 2003)

Note: The minimum count as defined in this paragraph refers to the use of the device in the filling of prescriptions and is different from the minimum sample piece count as defined in S.1.2.3. and as required to be marked on the scale by S.6.6.

(Note Added 2004)

UR.3.12. Correct Stored Piece Weight. – For prescription scales with a counting feature, the user is responsible for maintaining the correct stored piece weight. This is especially critical when a medicine has been reformulated or comes from different lots.

(Added 2003)

UR.4. Maintenance Requirements.

UR.4.1. Balance Condition. – The zero-load adjustment of a scale shall be maintained so that, with no load on the load-receiving element and with all load-counterbalancing elements of the scale (such as poises, drop weights, or counterbalance weights) set to zero, the scale shall indicate or record a zero balance condition. A scale not equipped to indicate or record a zero-load balance shall be maintained in balance under any no-load condition.

UR.4.2. Level Condition. – If a scale is equipped with a level-condition indicator, the scale shall be maintained in level.

UR.4.3. Scale Modification. – The dimensions (e.g., length, width, thickness, etc.) of the load receiving element of a scale shall not be changed beyond the manufacturer's specifications, nor shall the capacity of a scale be increased beyond its design capacity by replacing or modifying the original primary indicating or recording element with one of a higher capacity, except when the modification has been approved by a competent engineering authority, preferably that of the engineering department of the manufacturer of the scale, and by the weights and measures authority having jurisdiction over the scale.

(Amended 1996)

UR.5. Coupled-in-Motion Railroad Weighing Systems. – A coupled-in-motion weighing system placed in service on or after January 1, 1991, should be tested in the manner in which it is operated, with the locomotive either pushing or pulling the cars at the designed speed and in the proper direction. The cars used in the test train should represent the range of gross weights that will be used during the normal operation of the weighing system. Except as provided in N.4.2. Weighing Systems Placed in Service Prior to January 1, 1991, and Used to Weigh Trains of Ten or More Cars and N.4.3.(a) Weighing Systems Placed in Service on or After January 1, 1991, and Used to Weigh Trains of Ten or More Cars, normal operating procedures should be simulated as nearly as practical. Approach conditions for a train length in each direction of the scale site are more critical for a weighing system used for individual car weights than for a unit-train-weights-only facility, and should be considered prior to installation.

(Added 1990) (Amended 1992)

THIS PAGE INTENTIONALLY LEFT BLANK

MARKUP COPY

Section 2.21. Belt-Conveyor Scale Systems

A. Application

A.1. General. – This code applies to belt-conveyor scale systems used for the weighing of bulk materials.

A.2. Exceptions. – The code does not apply to:

- (a) devices used for discrete weighing while moving on conveyors;
- (b) devices that measure quantity on a time basis;
- (c) checkweighers; or
- (d) controllers or other auxiliary devices except as they may affect the weighing performance of the belt-conveyor scale.

A.3. Additional Code Requirements. – In addition to the requirements of this code, Belt-Conveyor Scale Systems shall meet the requirements of Section 1.10. General Code.

S. Specifications

S.1. Design of Indicating and Recording Elements.

S.1.1. General. – A belt-conveyor scale shall be equipped with a primary indicating element in the form of a master weight totalizer *and shall also be equipped with a recording element, and a rate of flow indicator and recorder (which may be analog).** An auxiliary indicator shall not be considered part of the master weight totalizer.

*[*Nonretroactive as of January 1, 1986]*

(Amended 1986)

S.1.2. Units. – A belt-conveyor scale shall indicate and record weight units in terms of pounds, tons, long tons, metric tons, or kilograms. The value of a scale division (d) expressed in a unit of weight shall be equal to:

- (a) 1, 2, or 5; or
- (b) a decimal multiple or submultiples of 1, 2, or 5.

S.1.3. Value of the Scale Division.

S.1.3.1. For Scales Installed After January 1, 1986. – *The value of the scale division shall not be greater than 0.125 % ($1/800$) of the minimum totalized load.*

[Nonretroactive as of January 1, 1986]

(Added 1985)(Amended 2009)

S.1.3.2. For Scales Installed Before January 1, 1986. – The value of the scale division shall not be greater than $1/1200$ of the rated capacity of the device. However, provision shall be made so that compliance with the requirements of the zero-load test as prescribed in N.3.1. Zero Load Tests may be readily and accurately determined in 20 minutes of operation.

S.1.4. Recording Elements and Recorded Representations. – *The value of the scale division of the recording element shall be the same as that of the indicating element.*

- a) *The belt-conveyor scale system shall record the unit of measurement (i.e., kilograms, tonnes, pounds, tons, etc.), the date, and the time.*
- b) *The belt-conveyor scale system shall record the initial indication and the final indication of the master weight totalizer and the quantity.**

*All of the information in (a) and (b) must be recorded for each delivery.**

[Nonretroactive as of January 1, 1986]

*[*Nonretroactive as of January 1, 1994]*

(Amended 1993)

S.1.4.1. *The belt-conveyor scale system shall be capable of recording the results of automatic or semi-automatic zero load tests.***

*[**Nonretroactive as of January 1, 2004]*

(Added 2002)

S.1.5. Rate of Flow Indicators and Recorders. – *A belt-conveyor scale shall be equipped with a rate of flow indicator and an analog or digital recorder. Permanent means shall be provided to produce an audio or visual signal when the rate of flow is equal to or less than 20 % and when the rate of flow is equal to or greater than 100 % of the rated capacity of the scale. The type of alarm (audio or visual) shall be determined by the individual installation.*

[Nonretroactive as of January 1, 1986]

(Amended 1989 and 2004)

S.1.6. Advancement of Primary Indicating or Recording Elements. – *The master weight totalizer shall advance only when the belt conveyor is in operation and under load.*

(Amended 1989)

S.1.7. Master Weight Totalizer. – *The master weight totalizer shall not be resettable without breaking a security means.*

[Nonretroactive as of January 1, 1986]

S.1.8. Power Loss. – *In the event of a power failure of up to 24 hours, the accumulated measured quantity on the master weight totalizer of an electronic digital indicator shall be retained in memory during the power loss.*

[Nonretroactive as of January 1, 1986]

(Amended 1989)

S.1.9. Zero-Ready Indicator. – *A belt-conveyor scale shall be equipped with a zero-ready indicator that produces an audio or visual signal when the zero balance is within ± 0.12 % of the rated capacity of the scale during an unloaded belt condition. The type of indication (audio or visual) shall be determined by the individual installation.*

[Nonretroactive as of January 1, 2014]

(Added 2012)

S.2. Design of Weighing Elements. – *A belt-conveyor scale system shall be designed to combine automatically belt travel with belt load to provide a determination of the weight of the material that has passed over the scale.*

S.2.1. Speed Measurement. – *A belt-conveyor scale shall be equipped with a belt speed or travel sensor that will accurately sense the belt speed or travel whether the belt is empty or loaded.*

S.2.2. Adjustable Components. – An adjustable component that can affect the performance of the device (except as prescribed in S.3.1. Design of Zero-Setting Mechanism) shall be held securely in adjustment. (Amended 1998)

S.2.3. Overload Protection. – The load-receiving elements shall be equipped with means for overload protection of not less than 150 % of rated capacity. The accuracy of the scale in its normal loading range shall not be affected by overloading.

S.3. Zero Setting.

S.3.1. Design of Zero-Setting Mechanism. – Automatic and semiautomatic zero-setting mechanisms shall be so constructed that the resetting operation is carried out only after a whole number of belt revolutions and the completion of the setting or the whole operation is indicated. *An audio or visual signal shall be given when the automatic and semiautomatic zero-setting mechanisms reach the limit of adjustment of the zero-setting mechanism.**

(Amended 1999 and 2002)

*Except for systems that record the zero load reference at the beginning and end of a delivery, the range of the zero-setting mechanism shall not be greater than $\pm 2\%$ of the rated capacity of the scale without breaking the security means. For systems that record the zero-load reference at the beginning and end of a delivery, the range of zero-setting mechanism shall not be greater than $\pm 5\%$ without breaking the security means.***

*[*Nonretroactive as of January 1, 1990]*

*[**Nonretroactive as of January 1, 2004]*

(Amended 1989 and 2002)

S.3.1.1. Automatic Zero-Setting Mechanism. – *The automatic zero-setting mechanism shall indicate or record any change in the zero reference.*

[Nonretroactive as of January 1, 2010]

(Added 2009)

S.3.2. Sensitivity at Zero Load (For Type Evaluation). – *When a system is operated for a time period equal to the time required to deliver the minimum test load and with a test load calculated to indicate two scale divisions applied directly to the weighing element, the totalizer shall advance not less than one or more than three scale divisions. An alternative test of equivalent sensitivity, as specified by the manufacturer, shall also be acceptable.*

[Nonretroactive as of January 1, 1986]

S.4. Marking Requirements. – A belt-conveyor scale shall be marked with the following: (See Also see also G-S.1. Identification.)

- (a) the rated capacity in units of weight per hour (minimum and maximum);
- (b) the value of the scale division;
- (c) the belt speed in terms of feet (or meters) per minute at which the belt will deliver the rated capacity;
- (d) the load in terms of pounds per foot or kilograms per meter (determined by materials tests); and
- (e) *the operational temperature range if other than $-10\text{ }^{\circ}\text{C}$ to $40\text{ }^{\circ}\text{C}$ ($14\text{ }^{\circ}\text{F}$ to $104\text{ }^{\circ}\text{F}$).*

[Nonretroactive as of January 1, 1986]

S.5. Provision for Sealing. – *A device shall be designed using the format set forth in Table S.5. with provision(s) for applying a security seal that must be broken, or for using other approved means of providing security (e.g. data*

change audit trail available at the time of inspection), before any change that affects the metrological integrity of the device can be made to any electronic mechanism.

[Nonretroactive as of January 1, 1999]

(Added 1998)

| Table S.5. Categories of Device and Methods of Sealing | |
|---|---|
| <i>Categories of Devices</i> | <i>Methods of Sealing</i> |
| Category 1: <i>No remote configuration capability.</i> | <i>Seal by physical seal or two event counters: one for calibration parameters and one for configuration parameters.</i> |
| Category 3: <i>Remote configuration capability.</i> | <i>An event logger is required in the device; it must include an event counter (000 to 999), the parameter ID, the date and time of the change, and the new value of the parameter. A printed copy of the information must be available through the device or through another on-site device. The event logger shall have a capacity to retain records equal to 10 times the number of sealable parameters in the device, but not more than 1000 records are required. (Note: Does not require 1000 changes to be stored for each parameter.)</i> |

[Nonretroactive as of January 1, 1999]

(Table Added 1998)

N. Notes

N.1. General. – Belt-conveyor scales are capable of weighing bulk material accurately. (See Also see Tolerances.) However, their performance can be detrimentally affected by the conditions of the installation. (See Also see User Requirements.) The performance of the equipment is not to be determined by averaging the results of the individual tests. The results of all tests shall be within the tolerance limits.

(Amended 2002)

N.1.1. Official Test. – An official test of a belt-conveyor scale system shall include tests specified in N.3.1. Zero Load Tests, N.3.2. Material Tests, and, if applicable, N.3.3. Simulated Load Tests.

(Amended 2006)

N.1.2. Simulated Test. – Simulated loading conditions as recommended by the manufacturer and approved by the official with statutory authority may be used to properly monitor the system operational performance between official tests, but shall not be used for official certification.

(Amended 1991)

N.2. Conditions of Tests. – A belt-conveyor scale shall be tested after it is installed on the conveyor system with which it is to be used and under such environmental conditions as may normally be expected. Each test shall be conducted with test loads no less than the minimum test load. Before each test run, the inspector shall check the zero setting and adjust as necessary.

(Amended 1986, 2004, and 2009)

N.2.1. Initial Verification. – A belt-conveyor scale system shall be verified with a minimum of two test runs at each of the following flow rates:

- (a) normal use flow rate;
- (b) 35 % of the maximum rated capacity; and
- (c) an intermediate flow rate between these two points.

Test runs may also be conducted at any other rate of flow that may be used at the installation. A minimum of four test runs may be conducted at only one flow rate if evidence is provided that the system is used at a single flow rate and that rate does not vary in either direction by an amount more than 10 % of the normal flow rate that can be developed at the installation for at least 80 % of the time.

(Added 2004) (Amended 2009)

N.2.2. Subsequent Verification. – Subsequent testing shall include testing at the normal use flow rate and other flow rates used at the installation. The official with statutory authority may determine that testing only at the normal use flow rate is necessary for subsequent verifications if evidence is provided that the system is used to operate:

- (a) at no less than 70 % of the maximum rated capacity for at least 80 % of the time (excluding time that the belt is unloaded); or
- (b) with a normal use flow rate that does not vary by more than 10 % of the maximum rated capacity.

Example: If a belt-conveyor scale system has a maximum rated capacity of 200 tons per hour (tph), and the normal use flow rate is 150 tph (75 % of the maximum rated capacity), no testing at additional flow rates is required provided the flow rates remain above 140 tph for more than 80 % of the time. If the same device were operating with a normal use flow rate of 130 tph, it is operating at 65 % of the maximum rated capacity. In this case, testing at flow rates in addition to the normal use flow rate would be required if the normal use flow rate varies by more than 20 tph (10 % of the maximum rated capacity).

(Added 2004)

N.2.3. Minimum Test Load. – Except for applications where a normal weighment is less than 10 minutes, the minimum test load shall not be less than the largest of the following values.

- (a) 800 scale divisions;
- (b) the load obtained at maximum flow rate in one revolution of the belt; or
- (c) at least 10 minutes of operation.

For applications where a normal weighment is less than 10 minutes (e.g., belt-conveyor scale systems used exclusively to issue net weights for material conveyed by individual vehicles and railway track cars) the minimum test load shall be the normal weighment that also complies with (a) and (b).

The official with statutory authority may determine that a smaller minimum totalized load down to 2 % of the load totalized in 1 hour at the maximum flow rate may be used for subsequent tests, provided that:

1. the smaller minimum totalized load is greater than the quantities specified in (a) and (b); and
2. consecutive official testing with the minimum totalized loads described in N.2.3. (a), (b), or (c) and the smaller minimum test load has been conducted that demonstrates the system complies with applicable tolerances for repeatability, acceptance, and maintenance.

(Added 2004) (Amended 2008)

N.3. Test Procedures.

N.3.1. Zero-Load Tests. – A zero-load test shall be conducted to establish that the belt scale system (including the conveyor) is capable of holding a stable, in-service zero.

(Amended 1989 and 2002)

N.3.1.1. Determination of Zero. – A zero-load test is a determination of the error in zero, expressed as an internal reference, a percentage of the full-scale capacity, or a change in a totalized load over a whole number of complete belt revolutions. For belt-conveyor scales with electronic integrators, the test must be performed over a period of at least three minutes and with a whole number of complete belt revolutions. For belt-conveyor scales with mechanical integrators, the test shall be performed with no less than three complete revolutions or 10 minutes of operation, whichever is greater.

(Added 2002)

N.3.1.2. Test of Zero Stability. – The conveyor system shall be operated to warm up the belt and the belt scale shall be zero adjusted as required. A series of zero-load tests shall be carried out immediately before conducting the simulated load or materials test until the three consecutive zero-load tests each indicate an error which does not exceed $\pm 0.06\%$ of the totalized load at full scale capacity for the duration of the test. No adjustments can be made during the three consecutive zero-load test readings.

(Added 2002) (Amended 2004 and 2009)

N.3.1.3. Check for Consistency of the Conveyor Belt along Its Entire Length. – During a zero-load test with any operational low-flow lock-out disabled, the absolute value of the difference between the maximum and minimum totalizer readings indicated on the totalizer during any complete revolution of the belt shall not exceed 0.12% of the minimum test load.

Note: The end value of the zero-load test must meet the $\pm 0.06\%$ requirement referenced in the "Test for Zero Stability."

(Added 2002) (Amended 2004 and 2011)

N.3.2. Material Tests. – Material tests should be conducted using actual belt loading conditions. These belt loading conditions shall include, but are not limited to conducting materials tests using different belt loading points, all types and sizes of products weighed on the scale, at least one other belt speed, and in both directions of weighing.

On subsequent verifications, at least two individual tests shall be conducted. The results of all these tests shall be within the tolerance limits.

Either pass a quantity of pre-weighed material over the belt-conveyor scale in a manner as similar as feasible to actual loading conditions, or weigh all material that has passed over the belt-conveyor scale. Means for weighing the material test load will depend on the capacity of the belt-conveyor scale and availability of a suitable scale for the test. To assure that the test load is accurately weighed and determined, the following precautions shall be observed:

- (a) The containers, whether railroad cars, trucks, or boxes, must not leak, and shall not be overloaded to the point that material will be lost.
- (b) The actual empty or tare weight of the containers shall be determined at the time of the test. Stenciled tare weight of railway cars or trucks shall not be used. Gross and tare weights shall be determined on the same scale.
- (c) When a pre-weighed test load is passed over the scale, the belt-loading hopper shall be examined before and after the test to assure that the hopper is empty and that only the material of the test load has passed over the scale.

- (d) Where practicable, a reference scale should be tested within 24 hours preceding the determination of the weight of the test load used for a belt-conveyor scale material test.

A reference scale which is not “as found” within maintenance tolerance should have its accuracy re-verified after the belt-conveyor test with a suitable known weight load if the “as found” error of the belt-conveyor scale material test exceeds maintenance tolerance values.*

- (e) If any suitable known weight load other than a certified test weight load is used for re-verification of the reference scale accuracy, its weight shall be determined on the reference scale after the reference scale certification and before commencing the belt scale material test.*
- (f) The test shall not be conducted if the weight of the test load has been affected by environmental conditions.

*Note: Even if the reference scale is within maintenance tolerance it may require adjusting to be able to meet paragraph N.3.2.1. Accuracy of Material.

(Amended 1986, 1989, 1998, 2000, 2002, and 2009)

N.3.2.1. Accuracy of Material. – The quantity of material used to conduct a material test shall be weighed on a reference scale to an accuracy within 0.1 %. Scales typically used for this purpose include Class III and III L scales or a scale without a class designation as described in Handbook 44, Section 2.20., Table T.1.1. Tolerances for Unmarked Scales.

(Added 1989) (Amended 1991, 1993, 1998 and 2000)

N.3.3. Simulated Load Tests.

- (a) As required by the official with statutory authority, simulated load tests as recommended by the manufacturer are to be conducted between material tests to monitor the system’s operational performance, but shall not be used for official certification.

(Amended 1991)

- (b) A simulated load test consisting of at least three consecutive test runs shall be conducted as soon as possible, but not more than 12 hours after the completion of the material test, to establish the factor to relate the results of the simulated load test to the results of the material tests.

(Added 1990)

- (c) The results of the simulated load test shall repeat within 0.1 %.

(Added 1990)

(Amended 1989 and 1990)

T. Tolerances

T.1. Tolerance Values.³² – Maintenance and acceptance tolerances on materials tests, relative to the weight of the material, shall be ± 0.25 % of the test load.

(Amended 1993)

³² The variables and uncertainties included in the relative tolerance represent only part of the variables that affect the accuracy of the material weighed on belt-conveyor scales. If this tolerance was based on an error analysis beginning with mass standards through all of the test processes and following the principle expressed in Section 3.2. of the Fundamental Considerations in Appendix A, the tolerance would be 0.5 %.

(Added 1993)

T.1.1. Tolerance Values – Test of Zero Stability. – Immediately after material has been weighed over the belt-conveyor scale during the conduct of any material test run, the zero-load test shall be repeated. The change in the accumulated or subtracted weight during the zero-load test shall not exceed 0.12 % of the totalized load at full scale capacity for the duration of that test. If the range of zero adjustments during a complete (official) verification test exceeds 0.18 % of the totalized load at full scale capacity for the duration of the zero-load test, the official with statutory authority may establish an interval for zero-load testing during normal operation.

(Added 2004) (Amended 2009)

T.2. Tolerance Values, Repeatability Tests. – The variation in the values obtained during the conduct of materials tests shall not be greater than 0.25 % ($1/400$).

T.3. Influence Factors. – The following factors are applicable to tests conducted under controlled conditions only, provided that:

- (a) types of devices approved prior to January 1, 1986, and manufactured prior to January 1, 1988, need not meet the requirements of this section;
- (b) new types of devices submitted for approval after January 1, 1986, shall comply with the requirements of the section; and
- (c) all devices manufactured after January 1, 1988, shall comply with the requirements of this section.

T.3.1. Temperature. – Devices shall satisfy the tolerance requirements at temperatures from $-10\text{ }^{\circ}\text{C}$ to $40\text{ }^{\circ}\text{C}$ ($14\text{ }^{\circ}\text{F}$ to $104\text{ }^{\circ}\text{F}$).

T.3.1.1. Effect on Zero-Load Balance. – The zero-load indication shall not change by more than 0.035 % of the rated capacity of the scale (without the belt) for a change in temperature of $10\text{ }^{\circ}\text{C}$ ($18\text{ }^{\circ}\text{F}$) at a rate not to exceed $5\text{ }^{\circ}\text{C}$ ($9\text{ }^{\circ}\text{F}$) per hour.

(Amended 2004)

T.3.1.2. Temperature Limits. – *If a temperature range other than $-10\text{ }^{\circ}\text{C}$ to $40\text{ }^{\circ}\text{C}$ ($14\text{ }^{\circ}\text{F}$ to $104\text{ }^{\circ}\text{F}$) is specified for the device, the range shall be at least $30\text{ }^{\circ}\text{C}$ ($54\text{ }^{\circ}\text{F}$).*
[Nonretroactive as of January 1, 1990]

(Added 1989)

T.3.2. Power Supply, Voltage, and Frequency. – A belt-conveyor scale system shall satisfy the tolerance requirements over a range of 100 V to 130 V or 200 V to 250 V as appropriate and over a frequency range of 59.5 Hz to 60.5 Hz.

UR. User Requirements

UR.1. Installation Requirements.

UR.1.1. Protection from Environmental Factors. – The indicating elements, the lever system or load cells, and the load-receiving element of a belt-conveyor scale shall be adequately protected from environmental factors such as wind, moisture, dust, weather, and radio frequency interference (RFI) and electromagnetic interference (EMI) that may adversely affect the operation or performance of the device.

UR.1.2. Conveyor Installation. – The design and installation of the conveyor leading to and from the belt-conveyor scale is critical with respect to scale performance. The conveyor can be horizontal or inclined, but if inclined, the angle shall be such that slippage of material along the belt does not occur. Installation shall be in accordance with the scale manufacturer's instructions and the following:

- (a) **Installation - General.** – A belt-conveyor scale shall be so installed that neither its performance nor operation will be adversely affected by any characteristic of the installation, including but not limited to, the foundation, supports, covers, or any other equipment.
(Amended 2002)
- (b) **Live Portions of Scale.** – All live portions of the scale shall be protected with appropriate guard devices and clearances, as recommended by the scale manufacturer, to prevent accidental interference with the weighing operation. (Also see UR.3.1. Scale and Conveyor Maintenance.)
(Amended 2004)
- (c) **Storage of Simulated Load Equipment.** – Suitable protection shall be provided for storage of any simulated load equipment.
- (d) **Take-up Device.** – If the belt length is such that a take-up device is required, this device shall be of the counter-weighted type for either vertical or horizontal travel.
- (e) **Scale Location and Training Idlers.** – The scale shall be so installed that the first weigh idler of the scale is at least 6 m (20 ft) or five idler spaces, whichever is greater, from loading point, skirting, head or tail pulley, or convex curve in the conveyor. Any training idler shall be located at least 18 m (60 ft) from the centerline of the weigh span of the scale. Training idlers shall not be restrained at any time in order to force belt alignment.
(Amended 1998)
- (f) **Concave Curve.** – If there is a concave curve in the conveyor, before or after the scale, the scale shall be installed so that the belt is in contact with all the idler rollers at all times for at least 6 m (20 ft) or five idler spaces, whichever is greater, before and after the scale.³³ A concave curve shall start no closer than 12 m (40 ft) from the scale to the tangent point of the concave curve.
(Amended 1998)
- (g) **Tripper and Movable Pulleys.** – There shall be no tripper or movable head pulleys in the conveyor.
- (h) **Conveyor Length.** ~~The conveyor shall be no longer than 300 m (1000 ft) nor shorter than 12 m (40 ft) from head to tail pulley.~~
[Nonretroactive as of January 1, 1986]
- (h) **Conveyor Orientation.** – The conveyor may be horizontal or inclined, but, if inclined, the angle shall be such that slippage of material along the belt does not occur.
- (i) **Conveyor Stringers.** – Conveyor stringers at the scale and for not less than 6 m (20 ft) before and beyond the scale shall be continuous or securely joined and of sufficient size and so supported as to eliminate relative deflection between the scale and adjacent idlers when under load. The conveyor stringers should be so designed that the deflection between any two adjacent idlers within the weigh area does not exceed 0.6 mm (0.025 in) under load.

³³ Installing the belt scale five-idler spaces from the tail pulley or the infeed skirting will be in the area of least belt tension on the conveyor and should produce the best accuracy. The performance of a belt-conveyor scale may be adversely affected by a concave curve in the conveyor that is located between the loading point and the scale. Therefore, whenever possible, a belt-conveyor scale should not be installed with a concave curve in the conveyor between the loading point and the scale.

(Amended 1995 and 1998)

(j) **Identification of Scale Area.** – The scale area and five idlers on both ends of the scale shall be of a contrasting color, or other suitable means shall be used to distinguish the scale from the remainder of the conveyor installation, and the scale shall be readily accessible.

(Amended 1998)

(k) **Belt Composition and Maintenance.** – Conveyor belting shall be no heavier than is required for normal use. In a loaded or unloaded condition, the belt shall make constant contact with horizontal and wing rollers of the idlers in the scale area. Splices shall not cause any undue disturbance in scale operation ~~(Also see N.3. Test Procedures).~~

(Amended 1998, 2000, and 2001)

(l) **Uniformity of Belt Loading and Flow.** – The conveyor loading mechanism shall be designed to provide uniform belt loading. The distance from the loading point to the scale shall allow for adequate settling time of the material on the belt before it is weighed. Feeding mechanisms shall have a positive closing or stopping action so that material leakage does not occur. Feeders shall provide an even flow over the scale through the full range of scale operation. Sufficient impact idlers shall be provided in the conveyor under each loading point to prevent deflection of the belt during the time material is being loaded.

(m) **Belt Alignment.** – The belt shall not extend beyond the edge of the outermost roller of any carry side (top) roller in any area of the conveyor nor touch the conveyor structure on the return (bottom) side of the conveyor.

(Amended 1998 and 2008)

(Amended 2002, 2012, and ~~2012~~**2013**)

UR.1.3. Material Test. – A belt-conveyor scale shall be installed so that a material test can be conveniently conducted.

[Nonretroactive as of January 1, 1981]

UR.1.4. Belt Travel (Speed or Velocity). – The belt travel sensor shall be so positioned that it accurately represents the travel of the belt over the scale for all flow rates between the maximum and minimum values. The belt travel sensor shall be so designed and installed that there is no slip.

(Amended 2012)

UR.2. Use Requirements.

UR.2.1. Rate of Operation. – A belt-conveyor scale system shall be operated between 20 % and 100 % of its rated capacity.

(Amended 2004)

UR.2.2. Minimum Totalized Load. – Delivered quantities of less than the minimum test load shall not be considered a valid weighing.

UR.2.3. Security Means. – When a security means has been broken, it shall be reported to the official with statutory authority.

(Amended 1991)

UR.2.4. Loading. – The feed of material to the scale shall be controlled to assure that, during normal operation, the material flow is in accordance with the manufacturer's recommendation for rated capacity.

UR.2.5. Diversion or Loss of Measured Product. – There shall be no operation(s) or condition(s) of use that result in loss or diversion that adversely affects the quantity of measured product.

(Added 2005)

UR.2.6. Retention of Maintenance, Test, and Analog or Digital Recorder Information. – Records of calibration and maintenance, including conveyor alignment, analog or digital recorder, zero-load test, and material test data shall be maintained on site for at least the three concurrent years as a history of scale performance. Copies of any report as a result of a test or repair shall be mailed to the official with statutory authority as required. The current date and correction factor(s) for simulated load equipment shall be recorded and maintained in the scale cabinet.

(Added 2002)

(Amended 2012)

UR.3.2. Maintenance Requirements.

UR.3.1. Scale and Conveyor Maintenance. – Belt-conveyor scales and idlers shall be maintained and serviced in accordance with manufacturer’s instructions and the following:

(a) **Zero Balance.** – The zero balance condition of a belt-conveyor scale shall be maintained such that, prior to beginning any commercial transaction, with no load on the belt, the zero balance condition is within ± 0.12 % of the scale’s rated capacity.

(Added 2012)

(b) **Scale Clearance.** – The scale and area surrounding the scale shall be kept clean of debris or other foreign material that can detrimentally affect the performance of the system.

(c) **Weighed Material.** – There shall be provisions to ensure that weighed material does not adhere to the belt and return to the scale system area.

(Added 2004)

(d) **Simulated and Zero-Load Test Intervals.** – Zero-load tests and simulated load or material tests shall be conducted at periodic intervals between official tests and after a repair or mechanical adjustment to the conveyor system in order to provide reasonable assurance that the device is performing correctly. The minimum interval for periodic zero-load tests and simulated load tests shall be established by the official with statutory authority or according to manufacturer recommendations.

The actions to be taken as a result of the zero-load test are shown in the following table.

| Change in Zero ($\Delta 0$) | Actions to be Taken |
|--|---|
| If the change in zero is less than ± 0.25 % ($\Delta 0 < 0.25$ %) | Perform zero adjustment and proceed to simulated load test. |
| If the change in zero is ± 0.25 % to ± 0.5 % (0.25 % $\leq \Delta 0 \leq 0.5$ %) | Inspect the conveyor and weighing area for compliance with UR.2.1. Installation Requirements and repeat the zero-load test. |
| If the change in zero is greater than ± 0.5 % ($\Delta 0 > 0.5$ %) | Inspect the conveyor and weighing area for compliance with UR.2.1. Installation Requirements, repeat the zero-load test, and reduce the interval between zero-load tests. |

The action to be taken as a result of the simulated load or material tests is shown in the following table.

(Amended 2002)

| Change in Factor (Reference) Established in N.3.3.(b) [Δ N.3.3.(b)] | Action to be Taken |
|--|--|
| If the error is less than 0.25 % (Δ N.3.3.(b) < 0.25 %) | No Action |
| If the error is at least 0.25 % but not more than 0.6 % ($0.25 \% \leq \Delta$ N.3.3.(b) $\leq 0.6 \%$) | Inspect the conveyor and weighing area for compliance with UR.1. Installation Requirements and, after compliance is verified, repeat the test. If the result of that test remains greater than ± 0.25 %, a span correction shall be made and the official with statutory authority notified. (Amended 1991) |
| If the error is greater than 0.6 % but does not exceed 0.75 % ($0.6 \% < \Delta$ N.3.3.(b) $\leq 0.75 \%$) | Inspect the conveyor and weighing area for compliance with UR.1. Installation Requirements and, after compliance is verified, repeat the test. If the result of that test remains greater than ± 0.25 %, a span correction shall be made, the official with statutory authority shall be notified, and an official test shall be conducted. (Amended 1991) |
| If the error is greater than 0.75 % (Δ N.3.3.(b) > 0.75 %) | An official test is required. (Amended 1987) |

(e) **Scale Alignment.** – Alignment checks shall be conducted in accordance with the manufacturer’s recommendation when conveyor work is performed in the scale area. A material test is required after any realignment.

(Amended 1986 and 2000)

(f) **Simulated Load Equipment.** – Simulated load equipment shall be clean and properly maintained.

(g) **Zero Load Reference Information.** – When zero load reference information is recorded for a delivery, the information must be based upon zero load tests performed as a minimum both immediately before and immediately after the totalized load.

(Added 2002)

(Amended 2002, 2004, 2009, and 2012)

(Amended 2012)

UR.4. Compliance. – Prior to initial verification, the scale manufacturer or installer shall certify to the owner that the scale meets code requirements. Prior to initial verification and each subsequent verification, the scale owner or his agent shall notify the official with statutory authority in writing that the belt-conveyor scale system is in compliance with this specification and ready for material testing.

(Amended 1991)

Section 2.22. Automatic Bulk Weighing Systems³⁴

A. Application

A.1. General. – This code applies to automatic bulk weighing systems, that is, weighing systems adapted to the automatic weighing of a commodity in successive drafts of predetermined amounts automatically recording the no-load and loaded weight values and accumulating the net weight of each draft.

(Amended 1987)

A.2. Additional Code Requirements. – In addition to the requirements of this code, Automatic Bulk Weighing Systems shall meet the requirements of Section 1.10. General Code.

S. Specifications

S.1. Design of Indicating and Recording Elements and Recorded Representations.

S.1.1. Zero Indication. – Provisions shall be made to indicate and record a no-load reference value and, if the no-load reference value is a zero value indication, to indicate and record an out-of-balance condition on both sides of zero.

S.1.1.1. Digital Zero Indication. – A digital zero indication shall represent a balance condition that is within $\pm \frac{1}{2}$ the value of the scale division.

S.1.2. Value of Scale Division (*d*). – *The value of the scale division (*d*), expressed in a unit of weight, shall be equal to:*

- (a) 1, 2, or 5; or
- (b) a decimal multiple or submultiple of 1, 2, or 5; or
- (c) a binary submultiple of a unit of weight.

Examples: Scale divisions may be 0.01, 0.02, or 0.05; 0.1, 0.2, or 0.5; 1, 2, or 5; 10, 20, or 50; or $\frac{1}{2}$, $\frac{1}{4}$, $\frac{1}{8}$, $\frac{1}{16}$, etc.

[Nonretroactive as of January 1, 1986]

(Amended 1987)

S.1.3. Capacity Indication and Recorded Representation. – An indicating or recording element shall not indicate or record any values when the gross load is in excess of 105 % of the capacity of the system.

S.1.4. Weighing Sequence. – For systems used to receive (weigh in), the no-load reference value shall be determined and recorded only at the beginning of each weighing cycle. For systems used to deliver (weigh out), the no-load reference value shall be determined and recorded only after the gross load reference value for each weighing cycle has been indicated and recorded.

S.1.5. Recording Sequence. – Provision shall be made so that all weight values are indicated until the completion of the recording of the indicated value.

¹ (Title amended 1986)

S.1.6. Provision for Sealing Adjustable Components on Electronic Devices. – Provision shall be made for applying a security seal in a manner that requires the security seal to be broken before an adjustment can be made to any component affecting the performance of the device.

S.2. Design of Balance and Damping Mechanism.

S.2.1. Zero-Load Adjustment. – The weighing system shall be equipped with manual or semiautomatic means by which the zero-load balance or no-load reference value indication may be adjusted. Automatic zero-tracking and automatic zero-setting mechanisms are prohibited.

(Amended 2010)

S.2.1.1. Manual. – A manual zero-load or no-load reference value setting mechanism shall be operable or accessible only by a tool outside of or entirely separate from this mechanism or enclosed in a cabinet.

S.2.1.2. Semiautomatic. – A semiautomatic zero-load or no-load reference value setting mechanism shall meet the provisions of S.2.1.1. or shall be operable only when:

- (a) the indication is stable within ± 3 scale divisions; and
- (b) cannot be operated during a weighing operation.

S.2.2. Damping Means. – A system shall be equipped with effective means necessary to bring the indications quickly to a readable, stable equilibrium. Effective means shall also be provided to permit the recording of weight values only when the indication is stable within plus or minus three scale divisions for devices with 10 000 scale divisions, or plus or minus one division for devices with less than 10 000 scale divisions.

S.3. Interlocks and Gate Control.

S.3.1. Gate Position. – Provision shall be made to clearly indicate to the operator the position of the gates leading directly to and from the weigh hopper.

S.3.2. Interlocks. – Each automatic bulk weighing system shall have operating interlocks to provide for the following:

- (a) Product cannot be cycled and weighed if the weight recording element is disconnected or subjected to a power loss.
- (b) The recording element cannot print a weight if either of the gates leading directly to or from the weigh hopper is open.
- (c) A “low paper” sensor, when provided, is activated.
- (d) The system will operate only in the proper sequence in all modes of operation.
- (e) When an overflow alarm is activated, the system shall indicate and record an overflow condition.

(Amended 1993)

S.3.3. Overflow Sensor.

- (a) The weigh hopper shall be equipped with an overflow sensor which will cause the feed gate to close, activate an alarm, and inhibit weighing until the overflow condition has been corrected.

(Added 1993)

(b) *If the system is equipped with a lower garner or surge bin, that garner shall also be equipped with an overflow sensor which will cause the gate of the weigh hopper to remain open, activate an alarm, and inhibit weighing until the overflow condition has been corrected.*

[Nonretroactive as of January 1, 1998]

(Amended 1997)

S.4. Design of Weighing Elements.

S.4.1. Antifriction Means. – At all points at which a live part of the mechanism may come into contact with another part in the course of normal usage, frictional effects shall be reduced to a minimum by means of suitable antifriction means, opposing surfaces and points being properly shaped, finished, and hardened.

S.4.2. Adjustable Components. – An adjustable component, such as a potentiometer, shall be held securely in adjustment and, except for a component for adjusting level or a no-load reference value, shall not be adjustable from the outside of the device.

S.4.3. Multiple Load-Receiving Elements. – A system with a single indicating or recording element, or a combination indicating recording element, that is coupled to two or more load-receiving elements with independent weighing systems, shall be provided with means to prohibit the activation of any load-receiving element (or elements) not in use, and shall be provided with automatic means to indicate clearly and definitely which load-receiving element (or elements) is in use.

S.4.4. Venting. – All weighing systems shall be vented so that any internal or external pressure will not affect the accuracy or operation of the system.

S.5. Marking Requirements. (~~See also~~ Also see Section 1.10. General Code paragraph G-S.1. Identification.)

S.5.1. Capacity and Value of the Scale Division. – The capacity of the weighing system and the value of the scale division shall be clearly and conspicuously marked on the indicating element near the weight value indications.

S.5.2. Weighing Elements. – On a weighing element not permanently attached to an indicating element, there shall be clearly and permanently marked for the purposes of identification, the name, initials, or trademark of the manufacturer, the manufacturer's designation that positively identifies the pattern or design, and the nominal capacity.

S.5.3. Temperature Limits. – *Unless the temperature range is $-10\text{ }^{\circ}\text{C}$ to $+40\text{ }^{\circ}\text{C}$ ($14\text{ }^{\circ}\text{F}$ to $104\text{ }^{\circ}\text{F}$), the temperature range shall be marked on the device.*

[Nonretroactive as of January 1, 1986]

(Added 1985)

S.5.4. Accuracy Class.

(a) *All systems used to weigh grain shall be marked Class III.**

(b) *All other systems shall be marked either Class III or III L.**

(~~See~~ Also see Section 2.20. Scales Code for the parameters for these accuracy classes for scales. The specific requirements for automatic bulk weighing systems apply to these devices when there is a conflict between the Scales Code and the Automatic Bulk Weighing Systems Code.)*

[Nonretroactive as of January 1, 1986]

(Added 1985) (Amended 1992)

N. Notes

N.1. Testing Procedures.

N.1.1. Test Weights. – The increasing load test shall be conducted using test weights equal to at least 10 % of the capacity of the system:

(a) on automatic grain bulk-weighing systems installed after January 1, 1984; and

(b) on other automatic bulk-weighing systems installed after January 1, 1986.

(Amended 1987)

N.1.2. Increasing-Load Test. – An increasing-load test consisting of substitution and strain-load tests shall be conducted up to the used capacity of the weighing system.

(Amended 1987)

N.1.3. Decreasing-Load Test. – A decreasing-load test shall be conducted on devices used to weigh out.

(Added 1986)

N.1.4. Zero-Balance or No-Load Reference Value Change Test. – A test for change of zero-balance or no-load reference value shall be conducted on all scales after the removal of any test load. The change shall not be more than the minimum tolerance applicable.

N.1.5. Discrimination Test. – *A discrimination test shall be conducted on all automatic indicating scales with the weighing device in equilibrium at zero-load and at maximum test load, and under controlled conditions in which environmental factors are reduced to the extent that they will not affect the results obtained.*

[Nonretroactive as of January 1, 1986]

N.1.5.1. Digital Device. – On a digital device, this test is conducted from just below the lower edge of the zone of uncertainty for increasing-load tests, or from just above the upper edge of the zone of uncertainty for decreasing-load tests.

(Added 1987)

N.2. Verification (Testing) Standards. – Standard weights and masses used in verifying weighing devices shall comply with requirements of NIST Handbook 105-1 (Class F) or the tolerances expressed in Appendix A, Fundamental Considerations, paragraph 3.2. (i.e., one-third of the smallest tolerance applied).

T. Tolerances

T.1. Tolerance Application. – Tolerance values shall be applied to all indications and recorded representations of a weighing system.

T.1.1. To Errors of Underregistration and Overregistration. – The tolerances hereinafter prescribed shall be applied equally to errors of underregistration and errors of overregistration.

T.1.2. To Increasing-Load Tests. – Basic tolerances shall be applied.

T.1.3. To Decreasing-Load Tests. – Basic tolerances shall be applied to systems used to weigh out.

(Added 1986)

T.1.4. To Tests Involving Digital Indications or Representations. – To the tolerances that would otherwise be applied, there shall be added an amount equal to one-half the value of the scale division. This does not apply to digital indications or recorded representations that have been corrected for rounding using error weights.

(Added 1986)

T.2. Minimum Tolerance Values. – The minimum tolerance value shall not be less than half the value of the scale division.

T.2.1. For Systems Used to Weigh Construction Materials. – The minimum maintenance and acceptance tolerance shall be 0.1 % of the weighing capacity of the system, or the value of the scale division, whichever is less.

(Added 1986)

T.3. Basic Tolerance Values.

T.3.1. Acceptance Tolerance. – The basic acceptance tolerance shall be one-half the basic maintenance tolerance.

T.3.2. For Systems Used to Weigh Grain. – The basic maintenance tolerance shall be 0.1 % of test load.

T.3.3. For All Other Systems. – The basic maintenance tolerance shall be 0.2 % of test load.

(Amended 1986)

T.4. Time Dependence. – *At constant test conditions, the indication 20 seconds after the application of a load and the indication after one hour shall not differ by more than the absolute value of the applicable tolerance for the applied load.*

[Nonretroactive and enforceable as of January 1, 1987]

(Added 1986)

T.5. Repeatability. – The results obtained by several weighings of the same load under reasonably static test conditions shall agree within the absolute value of the maintenance tolerance for that load, and shall be within applicable tolerances.

(Added 1986)

T.6. Discrimination, Digital Automatic Indicating Scales. – A test load equivalent to 1.4 d shall cause a change in the indicated or recorded value of at least 2.0 d. This requires the zone of uncertainty to be not greater than 0.3 times the value of the scale division.

(Added 1985)

T.7. Influence Factors. – *The following factors are applicable to tests conducted under controlled conditions only, provided that:*

(a) *types of devices approved prior to January 1, 1986, and manufactured prior to January 1, 1988, need not meet the requirements of this section; and*

(b) *new types of devices submitted for approval after January 1, 1986, shall comply with the requirements of this section; and*

(c) *all devices manufactured after January 1, 1988, shall comply with the requirements of this section.*

[Nonretroactive as of January 1, 1986]

T.7.1. Temperature. – *Devices shall satisfy the tolerance requirements under the following temperature conditions:*

T.7.1.1. *If not marked on the device, the temperature limits shall be: – 10 °C to 40 °C (14 °F to 104 °F).*

T.7.1.2. *If temperature limits are specified for the device, the range shall be at least 30 °C (54 °F).*

T.7.1.3. Temperature Effect on Zero-Load Balance. – *The zero-load indicator shall not vary by more than one division per 5 °C (9 °F) change in temperature.*

T.7.1.4. Operating Temperature. – *An indicating or recording element shall not display or record any usable values until the operating temperature necessary for accurate weighing and a stable zero-balance condition has been attained.*

[Nonretroactive as of January 1, 1986]

T.7.2. Barometric Pressure. – *The zero indication shall not vary by more than one scale division for a change in barometric pressure of 1 kPa over the total barometric range of 95 kPa to 105 kPa (28 in to 31 in of mercury).*

[Nonretroactive as of January 1, 1986]

T.7.3. Electric Power Supply.

T.7.3.1. Power Supply, Voltage, and Frequency.

- (a) Weighing devices that operate using alternating current must perform within the conditions defined in paragraphs T.2. through T.7., inclusive over the line voltage range of 100 V to 130 V or 200 V to 250 V rms as appropriate and over the frequency range of 59.5 Hz to 60.5 Hz.
- (b) Battery-operated instruments shall not indicate nor record values outside the applicable tolerance limits when battery power output is excessive or deficient.

T.7.3.2. Power Interruption. – *A power interruption shall not cause an indicating or recording element to display or record any values outside the applicable tolerance limits.*

[Nonretroactive as of January 1, 1986]

(Added 1985)

UR. User Requirements

UR.1. Selection Requirements.

UR.1.1. For Systems used to Weigh Grain. – *The number of scale divisions of a weighing system shall not be less than 2 000 nor greater than 10 000 divisions.*

[Nonretroactive as of January 1, 1984]

(Amended 1986 and 1992)

UR.1.2. For Systems used to Weigh Commodities other than Grain. – *The number of scale divisions shall not be less than 500 nor greater than 10 000.*

[Nonretroactive as of January 1, 1987]

(Added 1986)

UR.2. Installation Requirements.

UR.2.1. Protection from Environmental Factors. – *The indicating elements, the lever system or load cells, the load-receiving element, and any permanently installed test weights shall be adequately protected from*

environmental factors such as wind, weather, and RFI that may adversely affect the operation or performance of the system.

UR.2.2. Foundation, Supports, and Clearance. – The foundation and supports of any system shall be such as to provide strength, rigidity, and permanence of all components, and clearance shall be provided around all live parts so that no contact can result before or during operation of the system.

UR.3. Loading Requirements.

UR.3.1. For Systems Used to Weigh Grain. – A system shall not be used to weigh drafts less than 40 % of the weighing capacity of the system except for a final partial draft. Loads shall not normally be retained on the weighing element for a period longer than a normal weighing cycle.

(Amended 1986)

UR.3.2. For Systems Used to Weigh Commodities Other than Grain. – *A system shall not be used to weigh drafts less than 20 % of the weighing capacity of the system except for a final partial draft. Loads shall not normally be retained on the weighing element for a period longer than a normal weighing cycle.*

[Nonretroactive as of January 1, 1987]

(Added 1986)

UR.4. System Modification. – The weighing system shall not be modified except when the modification has been approved by a competent engineering authority, preferably that of the engineering department of the manufacturer of the scale, and the official with statutory authority having jurisdiction over the scale.

(Amended 1991)

THIS PAGE INTENTIONALLY LEFT BLANK

MARKUP COPY

Section 2.23. Weights

A. Application

A.1. General. – This code applies to commercial weights; that is, weights used in connection with commercial weighing devices.

A.2. Exceptions. – This code does not apply to test weights or to other “standards” of mass.

A.3. Additional Code Requirements. – In addition to the requirements of this code, Weights shall meet the requirements of Section 1.10. General Code.

S. Specifications

S.1. Material. – The material used for weights shall be as follows:

- (a) Weights of 6 g or 100 gr and larger shall be made of a metal, or a metal alloy, not softer than brass.
- (b) Weights of less than 6 g or 100 gr may be made of aluminum, but shall not be made of iron or of unplated steel, except stainless steel.

S.2. Design.

S.2.1. Surface. – The surface of a weight shall be smooth and shall not be coated with thick, soft, or brittle material. A weight of more than 2 g or 30 gr or shall not have sharp edges, points, or corners.

S.2.2. Ring. – A ring on a weight shall not be split or removable.

S.3. Adjusting Material. – Adjusting material shall be securely positioned and shall not project beyond the surface of the weight.

S.4. Marking Requirements.

S.4.1. General. – A weight shall be marked to show clearly its nominal value, which shall include identification of the unit; however, the nominal value of a weight of 30 gr or 2 g, or less, may be designated by dots, lines, figures, distinctive shape, or other appropriate means.

S.4.2. Apothecaries’ Weights. – On apothecaries’ dram, ounce, and pound weights, the letters “ap” shall be used in combination with the nominal value and the appropriate abbreviation of or symbol for the unit.

S.4.3. Troy Weights. – On troy ounce and pound weights, the letter “t” shall be used in combination with the nominal value and the appropriate symbol of the unit.

S.4.4. Metric Weights. – On metric weights, the symbols “kg,” “g,” and “mg” shall be used in combination with the nominal value of kilograms, grams, and milligrams, respectively.

S.4.5. Carat Weights. – On carat weights, the letter “c” shall be used in combination with the nominal value.

S.4.6. Counterpoise Weight. – A counterpoise weight shall be marked to show clearly both its nominal value and the value it represents when used on the multiplying-lever scale for which it is intended.

N. Notes

N.1. Testing Procedures. – Commercial weights should be tested on a precision balance using standard weights, the errors of which, when used without correction, do not exceed $\frac{1}{3}$ of the smallest tolerance to be applied. (See Appendix A, Fundamental Considerations, paragraphs 3.2. Tolerance for ~~Standards~~ **Standards** and 3.3. Accuracy of Standards.)

T. Tolerances

T.1. In Excess and In Deficiency. – The tolerances hereinafter prescribed shall be applied equally to errors in excess and errors in deficiency.

T.2. On Avoirdupois Weights. – The maintenance tolerances shall be as shown in Table 1. Maintenance Tolerance for Avoirdupois Weights. Acceptance tolerances shall be one-half the maintenance tolerances.

MARKUP COPY

| Table 1. | | | | | | |
|--|--------------------------|-----------|--|-----------|--|-----------|
| Maintenance Tolerance for Avoirdupois Weights | | | | | | |
| Maintenance Tolerance | | | | | | |
| Nominal Value | Equal-Arm Weights | | Counterpoise Weights | | | |
| | | | For scales with multiples of less than 1000 | | For scales with multiples of 1000 or over | |
| oz | Grains | mg | Grains | mg | Grains | mg |
| 1/64 | 0.1 | 6 | | | | |
| 1/32 | 0.3 | 19 | | | | |
| 1/16 | 0.4 | 26 | | | | |
| 1/8 | 0.5 | 32 | | | | |
| 1/4 | 1.0 | 65 | | | | |
| 1/2 | 1.5 | 97 | 1.0 | 65 | | |
| 1 | 1.7 | 110 | 1.0 | 65 | | |
| 2 | 2.0 | 130 | 1.0 | 65 | | |
| 3 | 2.0 | 130 | 1.5 | 97 | | |
| 4 | 3.0 | 190 | 1.5 | 97 | 1.0 | 65 |
| 5 | 3.5 | 230 | 1.5 | 97 | 1.0 | 65 |
| 6 | 3.5 | 230 | 1.5 | 97 | | |
| 8 | 4.0 | 260 | 2.0 | 130 | 1.5 | 97 |
| 10 | 4.0 | 260 | 2.5 | 160 | 2.0 | 130 |
| 12 | 5.0 | 320 | 2.5 | 160 | 2.0 | 130 |
| Lb | Grains | mg | Grains | mg | Grains | mg |
| 1 | 5.0 | 320 | 3.0 | 190 | 2.5 | 160 |
| 2 | 7.0 | 450 | 6.0 | 390 | 4.0 | 260 |
| 3 | 9.0 | 580 | 9.0 | 580 | 5.0 | 320 |
| 4 | 11.0 | 710 | 11.0 | 710 | 6.0 | 390 |
| 5 | 15.0 | 970 | 12.0 | 780 | 6.5 | 420 |
| 6 | 17.0 | 1190 | | | | |
| 7 | 19.0 | 1200 | | | | |
| 8 | 21.0 | 1400 | 15.0 | 970 | 9.0 | 580 |
| 9 | 23.0 | 1500 | | | | |
| 10 | 25.0 | 1600 | 18.0 | 1160 | 10.0 | 650 |
| 15 | 28.0 | 1800 | | | | |
| 20 | 30.0 | 1900 | | | | |
| 25 | 35.0 | 2300 | | | | |
| 30 | 40.0 | 2600 | | | | |
| 40 | 45.0 | 2900 | | | | |
| 50 | 50.0 | 3200 | | | | |

T.3. On Metric Weights. – The maintenance tolerances shall be as shown in Table 2. Maintenance Tolerances for Metric Weights. Acceptance tolerances shall be one-half the maintenance tolerances.

T.4. On Carat Weights. – The maintenance tolerances shall be as shown in Table 2. Maintenance Tolerances for Metric Weights. Acceptance tolerances shall be one-half the maintenance tolerances.

| Table 2. Maintenance Tolerances for Metric Weights | | | |
|---|-----------------------------------|-------------------------------|-----------------------------------|
| Nominal Value (mg) | Maintenance Tolerance (mg) | Nominal Value (g) | Maintenance Tolerance (mg) |
| 5 or less | 0.1 | 1 | 4 |
| 10 | 0.3 | 2 | 6 |
| 20 | 0.4 | 3 | 8 |
| 30 | 0.6 | 5 | 10 |
| 50 | 0.8 | 10 | 15 |
| 100 | 1.0 | 20 | 20 |
| 200 | 1.5 | 30 | 30 |
| 300 | 2.0 | 50 | 40 |
| 500 | 3.0 | 100 | 70 |
| | | 200 | 100 |
| | | 300 | 150 |
| | | 500 | 175 |
| Nominal Value (kg) | Maintenance Tolerance (mg) | Nominal Value (carats) | Maintenance Tolerance (mg) |
| 1 | 250 | 0.25* | 0.6 |
| 2 | 400 | 0.5** | 1.0 |
| 3 | 500 | 1.0 | 1.5 |
| 5 | 800 | 2.0 | 2.0 |
| 10 | 1000 | 3.0 | 3.0 |
| 20 | 1500 | 5.0 | 4.0 |
| | | 10.0 | 6.0 |
| | | 20.0 | 10.0 |
| | | 30.0 | 12.0 |
| | | 50.0 | 15.0 |
| | | 100.0 | 25.0 |
| | | *25 points or less | |
| | | **50 points | |

T.5. On Apothecaries and Troy Weights. – The maintenance tolerances shall be as shown in Table 3. Maintenance Tolerances for Apothecaries' and Troy Weights. Acceptance tolerances shall be one-half the maintenance tolerances.

| Table 3. | | | | | |
|--|------------------------------|-----------|----------------------|------------------------------|-----------|
| Maintenance Tolerances for Apothecaries' and Troy Weights | | | | | |
| Nominal Value | Maintenance Tolerance | | Nominal Value | Maintenance Tolerance | |
| grains | grains | mg | oz | grains | mg |
| 1 | 0.01 | 0.6 | 1 | 0.4 | 25.0 |
| 2 | 0.02 | 1.3 | 2 | 0.6 | 40.0 |
| 3 | 0.03 | 2.0 | 3 | 1.0 | 65.0 |
| 5 | 0.03 | 2.0 | 4 | 1.5 | 100.0 |
| 10 | 0.04 | 2.5 | 5 | 1.6 | 105.0 |
| 20 | 0.06 | 4.0 | | | |
| scruples | grains | mg | oz | grains | mg |
| 1 | 0.06 | 4.0 | 6 | 1.8 | 115.0 |
| 2 | 0.10 | 6.5 | 7 | 1.9 | 125.0 |
| | | | 8 | 2.0 | 130.0 |
| | | | 9 | 2.1 | 135.0 |
| | | | 10 | 2.2 | 145.0 |
| dr | grains | mg | oz | grains | mg |
| 0.5 | 0.07 | 4.5 | 11 | 2.4 | 155.0 |
| 1.0 | 0.10 | 6.5 | 12 | 2.5 | 160.0 |
| 2.0 | 0.20 | 13.0 | 20 | 2.9 | 190.0 |
| 3.0 | 0.30 | 20.0 | 30 | 3.7 | 240.0 |
| 4.0 | 0.40 | 25.0 | 50 | 5.4 | 350.0 |
| 5.0 | 0.50 | 30.0 | | | |
| 6.0 | 0.60 | 40.0 | | | |
| dwt | grains | mg | oz | grains | mg |
| 1 | 0.06 | 4.0 | 100 | 7.7 | 500.0 |
| 2 | 0.10 | 6.5 | 200 | 12.3 | 800.0 |
| 3 | 0.15 | 10.0 | 300 | 15.4 | 1 000.0 |
| 4 | 0.20 | 13.0 | 500 | 23.1 | 1 500.0 |
| 5 | 0.30 | 20.0 | 1 000 | 38.6 | 2 500.0 |
| 10 | 0.40 | 25.0 | | | |

THIS PAGE INTENTIONALLY LEFT BLANK

MARKUP COPY

Section 2.24. Automatic Weighing Systems

A. Application

A.1. General. – This code applies to devices used to automatically weigh pre-assembled discrete loads or single loads or loose materials in applications where automatic weighing systems³⁵ are used or employed in the determination of quantities, things, produce, or articles for distribution, for purchase, offered or submitted for sale, for distribution, purchase, or in computing any basic charge or payment for services rendered on the basis of weight, and in packaging plants subject to regulation by the USDA. Some weigh-labelers and checkweighers may also include a scale that is incorporated in a conveyor system that weighs packages in a static or non-automatic weighing mode³⁶.

This includes:

- (a) Automatic weigh-labelers;
- (b) Combination automatic and non-automatic weigh-labelers;
- (c) Automatic checkweighers;
- (d) Combination automatic and non-automatic checkweighers; and
- (e) Automatic gravimetric filling machines that weigh discrete loads or single loads of loose materials and determine package and production lot compliance with net content representations.

(Amended 1997 and 2004)

A.2. Exceptions. - This code does not apply to:

- (a) Belt-Conveyor Scale Systems;
- (b) Railway Track Scales;
- (c) Monorail Scales;
- (d) Automatic Bulk-Weighing Systems;
- (e) Devices that measure quantity on a time basis;

³⁵ An automatic weighing system does not require the intervention of an operator during the weighing process. The necessity to give instructions to start a process or to release a load or the function of the instrument (static, dynamic, set-up, etc.) is not relevant in deciding the category of automatic or non-automatic instruments.

(Added 2004)

³⁶ Prepackaging scales (and other commercial devices) used for putting up packages in advance of sale are acceptable for use in commerce if all appropriate provisions of Handbook 44 are met. Users of such devices must be alert to the legal requirements relating to the declaration of quantity on a package. Such requirements are to the effect that, on the average, the contents of the individual packages of a particular commodity comprising a lot, shipment, or delivery must contain at least the quantity declared on the label. The fact that a scale or other commercial device may overregister, but within established tolerances, and is approved for commercial service is not a legal justification for packages to contain, on the average, less than the labeled quantity.

(Added 2004)

- (f) Controllers or other auxiliary devices except as they may affect the weighing performance; or
- (g) Automatic gravimetric filling machines and other automatic weighing systems employed in determining the weight of a commodity in a plant or business with a separate quantity control program (e.g., a system of statistical process control) using suitable weighing instruments and measurement standards traceable to national standards to determine production lot compliance with net content representations.³⁷
(Added 2004)

A.3. Additional Code Requirements. – In addition to the requirements of this code, Automatic Weighing Systems shall meet the requirements of Section 1.10. General Code.

S. Specifications

S.1. Design of Indicating and Recording Elements and of Recorded Representations.

S.1.1. Zero Indication.

- (a) A weigh-labeler shall be equipped with an indicating or recording element. Additionally, a weigh-labeler equipped with an indicating or recording element shall either indicate or record a zero-balance condition and an out-of-balance condition on both sides of zero.
(Amended 2004)
- (b) An automatic checkweigher may be equipped with an indicating or recording element.
- (c) A zero-balance condition may be indicated by other than a continuous digital zero indication, provided that effective automatic means is provided to inhibit a weighing operation or to return to a continuous digital indication when the device is in an out-of-balance condition.

S.1.1.1. Digital Indicating Elements.

- (a) A digital zero indication shall represent a balance condition that is within $\pm \frac{1}{2}$ scale division.
- (b) A digital indicating device shall either automatically maintain a “center of zero” condition to $\pm \frac{1}{4}$ scale division or less, or have an auxiliary or supplemental “center-of-zero” indicator that defines a zero-balance condition to $\pm \frac{1}{4}$ scale division or less.
- (c) Verification of the accuracy of the center of zero indication to $\pm \frac{1}{4}$ scale division or less during automatic operation is not required on automatic checkweighers.
(Amended 2004)

S.1.2. Value of Division Units. – The value of a division d expressed in a unit of weight shall be equal to:

- (a) 1, 2, or 5; or
- (b) a decimal multiple or submultiple of 1, 2, or 5.

The requirement that the value of the scale division be expressed only as 1, 2, or 5, or a decimal multiple or submultiple of only 1, 2, or 5 does not apply to net weight indications and recorded representations that are calculated from gross and tare weight indications where the scale division of the gross weight is different from the scale division of the tare weight(s) on multi-interval or multiple range scales. For example, a multiple range

³⁷ See NIST Handbook 130, Uniform Laws and Regulations in the Area of Legal Metrology and Engine Fuel Quality, Interpretations and Guidelines, paragraph 2.6.11. Good Quantity Control Practices.

or multi-interval scale may indicate and record tare weights in a lower weighing range (WR) or weighing segment (WS), gross weights in the higher weighing range or weighing segment, and net weights as follows:

| | |
|---|---|
| $\begin{array}{r} 55 \text{ kg Gross Weight (WR2 d = 5 kg)} \\ - 4 \text{ kg Tare Weight (WR1 d = 2 kg)} \\ \hline = 51 \text{ kg Net Weight (Mathematically Correct)} \end{array}$ | $\begin{array}{r} 10.05 \text{ lb Gross Weight (WS2 d = 0.05 lb)} \\ - 0.06 \text{ lb Tare Weight (WS1 d = 0.02 lb)} \\ \hline = 9.99 \text{ lb Net Weight (Mathematically Correct)} \end{array}$ |
|---|---|

(Amended 2008)

S.1.2.1. Weight Units. – Except for postal scales, indicating and recording elements for shipping and postal applications, and scales used to print standard pack labels, a device shall indicate weight values using only a single unit of measure.

(Amended 2004)

S.1.3. Provision for Sealing.

- (a) **Automatic Weighing Systems, Except Automatic Checkweighers.** – A device shall be designed with provision(s) as specified in Table S.1.3. Categories of Device and Methods of Sealing for applying a security seal that must be broken, or for using other approved means of providing security (e.g., data change audit trail available at the time of inspection), before any change that detrimentally affects the metrological integrity of the device can be made to any electronic mechanism.
- (b) **For Automatic Checkweighers.** – Security seals are not required in applications where it would prohibit an authorized user from having access to the calibration functions of a device.

| Table S.1.3. Categories of Device and Methods of Sealing | |
|--|--|
| Categories of Device | Methods of Sealing |
| Category 1: No Remote configuration capability. | Seal by physical seal or two event counters: one for calibration parameters and one for configuration parameters. |
| Category 2: Remote configuration capability, but access is controlled by physical hardware. The device shall clearly indicate that it is in the remote configuration mode and record such message if capable of printing in this mode. | The hardware enabling access for remote communication must be at the device and sealed using a physical seal or two event counters: one for calibration parameters and one for configuration parameters. |
| Category 3: Remote configuration capability access may be unlimited or controlled through a software switch (e.g., password). | An event logger is required in the device; it must include an event counter (000 to 999), the parameter ID, the date and time of the change, and the new value of the parameter. A printed copy of the information must be available through the device or through another on-site device. The event logger shall have a capacity to retain records equal to 10 times the number of sealable parameters in the device, but not more than 1 000 records are required. (Note: Does not require 1 000 changes to be stored for each parameter.) |

S.1.4. Automatic Calibration. – A device may be fitted with an automatic or a semi-automatic calibration mechanism. This mechanism shall be incorporated inside the device. After sealing, neither the mechanism nor the calibration process shall facilitate fraud.

S.1.5. Adjustable Components. – Adjustable components shall be held securely in adjustment and, except for a zero-load balance mechanism, shall be located within the housing of the element.

S.2. Design of Zero and Tare Mechanisms.

S.2.1. Zero Load Adjustment.

S.2.1.1. Automatic Zero-Tracking Mechanism. – Except for automatic checkweighers, under normal operating conditions the maximum load that can be “rezeroed,” when either placed on or removed from the platform all at once, shall be 1.0 scale division.

Except for an initial zero-setting mechanism, an automatic zero adjustment outside these limits is prohibited.

(Amended 2004 and 2010)

S.2.1.2. Initial Zero-Setting Mechanism. – Except for automatic checkweighers, an initial zero-setting mechanism shall not zero a load in excess of 20 % of the maximum capacity of the automatic weighing system unless tests show that the scale meets all applicable tolerances for any amount of initial load compensated by this device within the specified range.

S.2.2. Tare. – On any automatic weighing system (except for multi-interval scales or multiple range scales when the value of tare is determined in a lower weighing range or weighing segment) the value of the tare division shall be equal to the value of the scale division. The tare mechanism shall operate only in a backward direction (i.e., in a direction of underregistration) with respect to the zero-load balance condition of the automatic weighing system. A device designed to automatically clear any tare value shall also be designed to prevent the automatic clearing of tare until a complete transaction has been indicated.

(Amended 2008)

Note: On a computing automatic weighing system, this requires the input of a unit price, the display of the unit price, and a computed positive total price at a readable equilibrium. Other devices require that a transaction or lot run be completed.

(Note Amended 2004)

S.3. Verification Scale Interval.

S.3.1. Multiple Range and Multi-Interval Automatic Weighing System. – The value of e shall be equal to the value of d.

S.3.2. Load Cell Verification Interval Value. – The relationship of the value for the load cell verification scale interval, v_{\min} , to the scale division d for a specific scale installation shall be:

$$v_{\min} \leq \frac{d}{\sqrt{N}}, \quad \text{where } N \text{ is the number of load cells in the scale.}$$

Note: When the value of the scale division d differs from the verification scale division e for the scale, the value of e must be used in the formula above.

S.3.3. – For automatic checkweighers, the value of e shall be specified by the manufacturer and may be larger than d, but in no case can e be more than ten times the value of d.

S.4. Weight Indicators, Weight Displays, Reports, and Labels.

S.4.1. Additional Digits in Displays. – Auxiliary digital displays that provide additional digits for use during performance evaluation may be included on automatic checkweighers. However, in cases where these indications are not valid for determining the actual weight of a package (e.g., only appropriate for use in statistical process control programs by users) they shall be clearly and distinctly differentiated from valid weight displays by indicating them to the user.

For example, the additional digits may be differentiated by color, partially covered by placing crosshatch overlays on the display, or made visible only after the operator presses a button or turns a key to set the device in a mode which enables the additional digits.

S.4.2. Damping. – An indicating element equipped with other than automatic recording elements shall be equipped with effective means to permit the recording of weight values only when the indication is stable within plus or minus one scale division. The values recorded shall be within applicable tolerances.

S.4.3. Over Capacity Indication. – An indicating or recording element shall not display nor record any values when the scale capacity is exceeded by nine scale divisions.

S.4.4. Label Printer. – A device that produces a printed ticket to be used as the label for a package shall print all values digitally and of such size, style of type, and color as to be clear and conspicuous on the label.

S.4.4.1. Label Printing. – If an automatic checkweigher prints a label containing weight information that will be used in a commercial transaction, it must conform to all of the requirements specified for weigh-labelers so that the printed ticket meets appropriate requirements.

S.5. Accuracy Class.

S.5.1. Marking. – Weigh-labelers and automatic checkweighers shall be Class III devices and shall be marked accordingly, except that a weigh-labeler marked Class IIIS may be used in package shipping applications.

(Amended 1997)

S.6. Parameters for Accuracy Classes. – The number of divisions for device capacity is designated by the manufacturer and shall comply with parameters shown in Table S.6.

| Table S.6. Parameters for Accuracy Classes | | | |
|---|---|--------------------------------|----------------|
| | | Number of Divisions (n) | |
| Class | Value of the Verification Division (e) | Minimum | Maximum |
| SI Units | | | |
| III | 0.1 to 2 g inclusive | 100 | 10 000 |
| | equal to or greater than 5 g | 500 | 10 000 |
| Inch-Pound Units | | | |
| III | 0.0002 lb to 0.005 lb, inclusive | 100 | 10 000 |
| | 0.005 oz to 0.125 oz, inclusive | 100 | 10 000 |
| | equal to or greater than 0.01 lb | 500 | 10 000 |
| | equal to or greater than 0.25 oz | 500 | 10 000 |
| IIIS | greater than 0.01 lb | 100 | 1 000 |
| | greater than 0.25 oz | 100 | 1 000 |
| For Class III devices, the value of e is specified by the manufacturer as marked on the device; d shall not be smaller than 0.1 e. e shall be differentiated from d by size, shape, or color. | | | |

(Amended 2004)

S.7. Marking Requirements. [See also G-S.1. Identification, G-S.4. Interchange or Reversal of Parts, G-S.6. Marking Operational Controls, Indications, and Features, G-S.7. Lettering, G-UR.2.1.1. Visibility of Identification, and UR.3.3. Special Designs]

S.7.1. Location of Marking Information. – Automatic weighing systems which are not permanently attached to an indicating element, and for which the load-receiving element is the only part of the weighing/load-receiving element visible after installation, may have the marking information required in G-S.1. Identification of the General Code and Table S.7.a. Marking Requirements and S.7.b. Notes for Table S.7.a. of the Automatic Weighing Systems Code located in an area that is accessible only through the use of a tool; provided that the information is easily accessible (e.g., the information may appear on the junction box under an access plate). The identification information for these automatic weighing systems shall be located on the weighbridge (load-receiving element) near the point where the signal leaves the weighing element, or beneath the nearest access cover.

MARKUP COPY

Table S.7.a. Marking Requirements

| To Be Marked With ↓ | Weighing Equipment | | | | |
|--|--|--|--|------------------------|-------------------------------|
| | Weighing, load-receiving, and indicating element in same housing | Indicating element not permanently attached to weighing and load-receiving element | Weighing and load-receiving element not permanently attached to indicating element | Load cell with CC (10) | Other equipment or device (9) |
| Manufacturer's ID (1) | x | x | x | x | x |
| Model Designation (1) | x | x | x | x | x |
| Serial Number and Prefix (2) | x | x | x | x | x (13) |
| Certificate of Conformance (CC) Number (16) | x | x | x | x | x (16) |
| Accuracy Class (14) | x | x (8) | x | x | |
| Nominal Capacity (3)(15) | x | x | x | | |
| Value of Division, d (3) | x | x | | | |
| Value of e (4) | x | x | | | |
| Temperature Limits (5) | x | x | x | x | |
| Special Application (11) | x | x | x | | |
| Maximum Number of Scale Divisions, n_{max} (6) | | x (8) | x | x | |
| Minimum Verification Division, (e_{min}) | | | x | | |
| "S" or "M" (7) | | | | x | |
| Direction of Loading (12) | | | | x | |
| Minimum Dead Load | | | | x | |
| Maximum Capacity (Max) | x | | | x | |
| Minimum Capacity (Min) | x | | | | |
| Safe Load Limit | | | | x | |
| Load Cell Verification Interval (v_{min}) | | | | x | |
| Maximum Belt Speed (m/sec or m/min) | x | | x | | |

Note: See Table S.7.b. for applicable parenthetical notes.

(Amended 1999)

Table S.7.b.
Notes for Table S.7.a.

1. Manufacturer's identification and model designation. (See G-S.1. Identification)
2. Serial number and prefix. (See G-S.1. Identification)
3. The nominal capacity and value of the automatic weighing system division shall be shown together (e.g., 50 000 x 5 kg, or 30 x 0.01 lb) adjacent to the weight display when the nominal capacity and value of the automatic weighing system division are not immediately apparent. Each division value or weight unit shall be marked on variable-division value or division-unit automatic weighing systems.
4. Required only if different from d.
5. Required only on automatic weighing systems if the temperature range on the NTEP CC is narrower than and within – 10 °C to 40 °C (14 °F to 104 °F).
(Amended 2007)
6. This value may be stated on load cells in units of 1000; (e.g., n_{\max} 10 is 10 000 divisions.)
7. Denotes compliance for single or multiple load cell applications.
8. An indicating element not permanently attached to a weighing element shall be clearly and permanently marked with the accuracy Class III, or IIIS and the maximum number of divisions, n_{\max} .
9. Necessary to the weighing system but having no metrological effect, e.g., auxiliary remote display, keyboard, etc.
10. The markings may be either on the load cell or in an accompanying document; except that, if an accompanying document is provided, the serial number shall appear both on the load cell and in the document. The manufacturer's name or trademark, the model designation, and identifying symbol for the serial number shall also be marked both on the load cell and in any accompanying document.
11. An automatic weighing system designed for a special application rather than general use shall be conspicuously marked with suitable words visible to the operator and customer restricting its use to that application.
12. Required if the direction of loading the load cell is not obvious.
13. Serial number and prefix (See G-S.1. Identification) modules without "intelligence" on a modular system (e.g., printer, keyboard module, cash drawer, and secondary display in a point-of-sale system) are not required to have serial numbers.
14. The accuracy class of a device shall be marked on the device with the appropriate designation.
15. The nominal capacity shall be conspicuously marked on any automatic-indicating or recording automatic weighing system so constructed that the capacity of the indicating or recording element, or elements, is not immediately apparent.
16. Required only if a CC has been issued for the equipment.

S.7.2. Marking Required on Components of Automatic Weighing Systems. – The following components of automatic weighing systems shall be marked as specified in Tables S.7.a. Marking Requirements and S.7.b. Notes for Table S.7.2.a.:

- (a) Main elements and components when not contained in a single enclosure for the entire automatic weighing system;
- (b) Load cells for which Certificates of Conformance (CC) have been issued under the National Type Evaluation Program; and
- (c) Other equipment necessary to a weighing system but having no metrological effect on the weighing system.

N. Notes

N.1. Test Requirements for Automatic Weighing Systems.

N.1.1. Test Pucks and Packages.

- (a) Test pucks and packages shall be:
 - (1) representative of the type, size, and weight ranges to be weighed on a device; and
 - (2) stable while in motion, hence the length and width of a puck or package should be greater than its height.
- (b) For type evaluation the manufacturer shall supply the test pucks or packages for each range of test loads.

(Amended 1997)

N.1.2. Accuracy of Test Pucks or Packages. – The error in any test puck or package shall not exceed one-fourth ($\frac{1}{4}$) of the acceptance tolerance. If packages are used to conduct field tests on automatic weighing systems, the package weights shall be determined on a reference scale or balance with an inaccuracy that does not exceed one-fifth ($\frac{1}{5}$) of the smallest tolerance that can be applied to the device under test.

N.1.3. Verification (Testing) Standards. – Field standard weights shall comply with requirements of NIST Handbook 105-1 (Class F) or the tolerances expressed in Fundamental Considerations, paragraph 3.2. (i.e., one-third of the smallest tolerance applied).

N.1.4. Radio Frequency Interference (RFI) and Other Electromagnetic Interference Susceptibility, Field Evaluation. – An RFI test shall be conducted at a given installation when the presence of RFI has been verified and characterized if those conditions are considered “usual and customary.”

(Added 2004)

N.1.5. Tests Loads. – A performance test shall consist of four separate test runs conducted at different test loads according to Table N.1.5. Test Loads.

| Table N.1.5. Test Loads |
|---|
| At or near minimum capacity |
| At or near maximum capacity |
| At two (2) critical points between minimum and maximum capacity |
| Test may be conducted at other loads if the device is intended for use at other specific capacities |

N.1.6. Influence Factor Testing. – Influence factor testing shall be conducted statically.

N.2. Test Procedures - Weigh-Labelers. – If the device is designed for use in a non-automatic weighing mode, it shall be tested in the non-automatic mode according to Handbook 44 Section 2.20. Scales Code.

Note: If the device is designed for only automatic weighing, it shall only be tested in the automatic weighing mode.
(Amended 2004)

N.2.1. Non-Automatic Tests.

N.2.1.1. Increasing-Load Test. – The increasing-load test shall be conducted with the test loads approximately centered on the load-receiving element of the scale.

N.2.1.2. Decreasing-Load Test. – The decreasing-load test shall be conducted with the test loads approximately centered on the load-receiving element of the scale.

N.2.1.3. Shift Test. – To determine the effect of off-center loading, a test load equal to one-half (½) maximum capacity shall be placed in the center of each of the four points equidistant between the center and front, left, back, and right edges of the load receiver.

N.2.1.4. Discrimination Test. – A discrimination test shall be conducted with the weighing device in equilibrium at zero-load and at maximum test load, and under controlled conditions in which environmental factors are reduced to the extent that they will not affect the results obtained. This test is conducted from just below the lower edge of the zone of uncertainty for increasing-load tests, or from just above the upper edge of the zone of uncertainty for decreasing-load tests.

N.2.1.5. Zero-Load Balance Change. – A zero-load balance change test shall be conducted on all automatic weighing systems after the removal of any test load. The zero-load balance should not change by more than the minimum tolerance applicable. (See also G-UR.4.2. Abnormal Performance)

(Amended 2004)

N.2.2. Automatic Test Procedures.

N.2.2.1. Tests Non-Automatic. – If the automatic weighing system is designed to operate non-automatically, and is used in that manner, during normal use operation, it shall be tested non-automatically using mass standards. The device shall not be tested non-automatically if it is used only in the automatic mode.

N.2.2.2. Automatic Tests. – The device shall be tested at the normal operating speed using packages. Test runs should be conducted using at least two test loads distributed over its normal weighing range (e.g., near the lowest and highest ranges in which the device is typically operated.) Each test load should be run a minimum of ten consecutive times.

(Amended 2004)

N.3. Test Procedures - Automatic Checkweigher.

N.3.1. Tests Non-Automatic. – If the scale is designed to operate non-automatically during normal user operation, it shall be tested non-automatically according to paragraphs N.2.1.1. Increasing Load Test through N.2.1.5. Zero-Balance Change.

(Amended 2004)

N.3.2. Automatic Tests. – The device shall be tested at the highest speed in each weight range using standardized test pucks or packages. Test runs shall be conducted using two test loads. The number of consecutive test weighments shall be as specified in Table N.3.2. Number of Sample Weights per Test for Automatic Checkweighers.

(Amended 2004)

| Weighing Range m = mass of test load | Number of Sample Weights per Test | |
|--|--|------------------------|
| | Field | Type Evaluation |
| 20 divisions $\leq m \leq 10$ kg 20 divisions $\leq m \leq 22$ lb | 30 | 60 |
| 10 kg $< m \leq 25$ kg 22 lb $< m \leq 55$ lb | 16 | 32 |
| 25 kg $< m \leq 100$ kg 55 lb $< m \leq 220$ lb | 10 | 20 |
| 100 kg (220 lb) $< m$ | 10 | 10 |

T. Tolerances

T.1. Principles.

T.1.1. Design. – The tolerance for a weighing device is a performance requirement independent of the design principle used.

T.1.2. Scale Division. – The tolerance for a weighing device is related to the value of the scale division (d) or the value of the verification scale division (e) and is generally expressed in terms of d or e. The random tolerance for automatic checkweighers is expressed in terms of Maximum Allowable Variance (MAV).

T.2. Tolerance Application.

T.2.1. General. – The tolerance values are positive (+) and negative (–) with the weighing device adjusted to zero at no load. When tare is in use, the tolerance values are applied from the tare zero reference (zero net weight indication); the tolerance values apply to the net weight indication for any possible tare load using certified test loads.

(Amended 2008)

T.2.2. Type Evaluation Examinations. – For type evaluation examinations, the tolerance values apply to increasing and decreasing load tests within the temperature and power supply limits specified in T.7. Influence Factors.

(Amended 2004)

T.2.3. Subsequent Verification Examinations. – For subsequent verification examinations, the tolerance values apply regardless of the influence factors in effect at the time of the conduct of the examination. (Also see G-N.2. Testing with ~~Non-associated~~Nonassociated Equipment)
(Added 2007)

T.2.4. Multiple Range and Multi-Interval Automatic Weighing System. – For multiple range and multi-interval devices, the tolerance values are based on the value of the scale division of the range in use.

T.3. Tolerance Values.

| Table T.3. Class III - Tolerance in Divisions (e) | | |
|--|------------------------|-------------|
| Test Load in Divisions | Tolerance in Divisions | |
| Class III | Acceptance | Maintenance |
| 0 - 500 | ± 0.5 | ± 1 |
| 501 - 2000 | ± 1.0 | ± 2 |
| 2001 - 4000 | ± 1.5 | ± 3 |
| 4001 + | ± 2.5 | ± 5 |

T.3.1. Tolerance Values – Class III Weigh-Labeler. (See Section T.3.2. Class IIIS Weigh-Labelers)

T.3.1.1. Non-automatic Tests. – Tolerance values shall be as specified in Table T.3. Class III - Tolerance in Divisions (e).
(Amended 2004)

T.3.1.2. Automatic Tests. – Acceptance tolerance values shall be the same as maintenance tolerance values specified in Table T.3. Class III - Tolerance in Divisions (e).
(Amended 2004)

T.3.2. Tolerance Values - Class IIIS Weigh-labelers in Package Shipping Applications.
(Added 1997)

T.3.2.1. Non-automatic Tests. – Tolerance values shall be as specified in Table T.3.2.1. Non-automatic Tolerances for Class IIIS Weigh-labelers.
(Amended 2004)

T.3.2.2. Automatic Tests. – Tolerance values specified in Table T.3.2.2. Automatic Tolerances for Class IIIS Weigh-labelers shall be applied.
(Amended 2004)

| Table T.3.2.1. Non-automatic Tolerances for Class IIIS Weigh-labelers | | |
|---|------------------------|-------------|
| Test Load in Divisions | Tolerance in Divisions | |
| Class IIIS | Acceptance | Maintenance |
| 0 - 50 | ± 0.5 | ± 1 |
| 51 - 200 | ± 1.0 | ± 2 |
| 201 - 1000 | ± 1.5 | ± 3 |

(Added 1997) (Amended 2004)

| Table T.3.2.2. Automatic Tolerances for Class IIIS Weigh-labelers | | |
|---|------------------------|-------------|
| Test Load in Divisions | Tolerance in Divisions | |
| Class IIIS | Acceptance | Maintenance |
| 0 - 50 | ± 1.5 | ± 2 |
| 51 - 200 | ± 2.0 | ± 3 |
| 201 - 1000 | ± 2.5 | ± 4 |

(Added 1997) (Amended 2004)

T.3.3. Tolerance Values. – Automatic Checkweighers.**T.3.3.1. Laboratory Tests for Automatic Checkweighers.**

T.3.3.1.1. Non-Automatic Tests. – The acceptance tolerance values specified in Table T.3. Class III - Tolerance in Divisions (e), shall be applied.

(Amended 2004)

T.3.3.1.2. Automatic Tests.

- (a) The systematic error for each test run shall be within the acceptance tolerances specified in Table T.3. Class III - Tolerance in Divisions (e) for the test loads specified in Table N.1.5. Test Loads.

(Amended 2004)

- (b) The standard deviation of the results shall not exceed one-ninth ($1/9$) of the MAV for specific package weights (which means that three standard deviations cannot exceed one-third ($1/3$) of the MAV value) as required in the latest edition of NIST Handbook 133. This value does not change regardless of whether acceptance or maintenance tolerances are being applied to the device under test.

(Amended 2004)

- (1) For U.S. Department of Agriculture (USDA) inspected meat and poultry products packaged at a plant subject to inspection by the USDA Food Safety and Inspection Service, use Handbook 133 Table 2-9, U.S. Department of Agriculture, Meat and Poultry, Groups and Lower Limits for Individual Packages;

- (2) for all other packages with a labeled net quantity in terms of weight, use Handbook 133 Table 2-5, Maximum Allowable Variations for Packages Labeled by Weight; or

- (3) for all packages with a labeled net quantity in terms of liquid or dry volume use Handbook 133 Table 2-6, Maximum Allowable Variations for Packages Labeled by Liquid or Dry Volume.

(Amended 2004)

T.3.3.2. Field Tests for Automatic Checkweighers.

T.3.3.2.1. Non-Automatic Test. – The tolerance values shall be as specified in Table T.3. Class III – Tolerance in Divisions (e).

(Amended 2004)

T.3.3.2.2. Automatic Test.

- (a) The systematic error requirement is not applied in a field test.

- (b) The standard deviation of the test results shall not exceed one-ninth ($1/9$) of the MAV for specific package weights (which means that three standard deviations cannot exceed one-third ($1/3$) of the MAV value) as required in the latest Edition of NIST Handbook 133. This value does not change regardless of whether acceptance or maintenance tolerances are being applied to the device under test.

(Amended 2004)

- (1) For USDA inspected meat and poultry products packaged at a plant subject to inspection by the USDA Food Safety and Inspection Service, use Handbook 133 Table 2-9, U.S. Department of Agriculture, Meat and Poultry, Groups and Lower Limits for Individual Packages;
- (2) for all other packages with a labeled net quantity in terms of weight, use Handbook 133 Table 2-5, Maximum Allowable Variations for Packages Labeled by Weight; or
- (3) for all packages with a labeled net quantity in terms of liquid or dry volume use Handbook 133 Table 2-6. Maximum Allowable Variations for Packages Labeled by Liquid or Dry Volume.

T.4. Agreement of Indications. – In the case of a weighing system equipped with more than one indicating element or indicating element and recording element combination, the difference in the weight value indications of any load shall not be greater than the absolute value of the applicable tolerance for that load, and shall be within tolerance limits.

T.5. Repeatability. – The results obtained from several weighings of the same load under reasonably constant test conditions shall agree within the absolute value of the maintenance tolerance for that load, and shall be within applicable tolerances.

(Amended 2004)

T.6. Discrimination. – A test load equivalent to 1.4 d shall cause a change in the indicated or recorded value of at least 2.0 d. This requires the zone of uncertainty to be not greater than 0.3 d (See N.2.1.4. Discrimination Test).

(Amended 2004)

T.7. Influence Factors. – The following factors are applicable to tests conducted under controlled conditions only.

T.7.1. Temperature. – Devices shall satisfy the tolerance requirements under the following temperature conditions:

T.7.1.1. – ~~If~~ if not specified in the operating instructions or if not marked on the device, the temperature limits shall be: – 10 °C to 40 °C (14 °F to 104 °F).

T.7.1.2. – ~~If~~ if temperature limits are specified for the device, the range shall be at least 30 °C (54 °F).

T.7.1.3. Temperature Effect on Zero-Load Balance. – The zero-load indication shall not vary by more than one division per 5 °C (9 °F) change in temperature.

T.7.1.4. Operating Temperature. – The indicating or recording element shall not display nor record any usable values until the operating temperature necessary for accurate weighing and a stable zero balance condition have been attained.

T.7.2. Electric Power Supply.

T.7.2.1. Range of Voltages.

- (a) Automatic weighing systems that operate using alternating current must perform within the conditions defined in paragraphs T.3. through T.6., inclusive, when tested over the range of – 15 % to + 10 % of the marked nominal line voltage(s) at 60 Hz, or the voltage range marked by the manufacturer, at 60 Hz.

- (b) Automatic weighing systems that operate using DC current must perform within the conditions defined in paragraphs T.3. through T.6., inclusive, when tested over the range from minimum operating voltage³⁸ to + 20 % of the voltage marked on the instrument (nominal voltage).
- (c) Battery-operated electronic automatic weighing systems with external or plug-in power supply (AC or DC) shall either continue to function correctly or not indicate any weight values if the voltage is below the manufacturer's specified value, the latter being larger than or equal to the minimum operating voltage.⁴

Note: This requirement applies only to metrologically significant voltage supplies.

(Amended 2001)

(Amended 2004)

T.7.2.2. Power Interruption. – A power interruption shall not cause an indicating or recording element to display or record any values outside the applicable tolerance limits.

T.8. Radio Frequency Interference (RFI) and Other Electromagnetic Interference Susceptibility. – The difference between the weight indication with the disturbance and the weight indication without the disturbance (see also N.1.4. Radio Frequency Interference (RFI) and Other Electromagnetic Interference Susceptibility, Field Evaluation) shall not exceed one scale division (d) or the equipment shall:

- (a) blank the indication;
- (b) provide an error message; or
- (c) the indication shall be so completely unstable that it could not be interpreted, or transmitted into memory or to a recording element, as a correct measurement value.

(Amended 2004)

UR. User Requirements

UR.1. Selection Requirements. – Equipment shall be suitable for the service in which it is used with respect to elements of its design, including but not limited to, its capacity, number of scale divisions, value of the scale division or verification scale division, minimum capacity, and computing capability.

UR.1.1. General. – Automatic Weighing Systems shall be designated by the manufacturer for that service.

UR.1.2. Value of the Indicated and Recorded Scale Division. – The value of the division as recorded shall be the same as the division value indicated.

UR.2. Installation Requirements.

UR.2.1. Protection from Environmental Factors. – The indicating elements, the lever system or load cells, and the load-receiving element of a permanently installed scale, and the indicating elements of a scale not intended to be permanently installed, shall be adequately protected from environmental factors such as wind, weather, and RFI that may adversely affect the operation or performance of the device.

UR.2.2. Foundation, Supports, and Clearance. – The foundation and supports of any scale installed in a fixed location shall be such as to provide strength, rigidity, and permanence of all components, and clearance

³⁸ The minimum operating voltage is defined as the lowest possible operating voltage before the automatic weighing system no longer indicates nor records weight values.

(Added 2004)

shall be provided around all live parts to the extent that no contacts may result when the load-receiving element is empty, nor throughout the weighing range of the scale.

UR.2.3. Entry and Departure from Weighing Area. – The belt or other conveyance that introduces the weighed load to the weighing zone and that carries the weighed load away from the weighing zone shall be maintained per the manufacturer's recommendations.

UR.3. Use Requirements.

UR.3.1. Minimum Load. – The minimum load shall be as specified by the manufacturer, but not less than twenty divisions since the use of a device to weigh light loads is likely to result in relatively large errors.

UR.3.1.1. Minimum Load for Class IIIS Weigh-labelers. – The minimum load shall be as specified by the manufacturer, but not less than ten divisions since the use of a device to weigh light loads is likely to result in relatively large errors.

(Added 1997)

UR.3.2. Maximum Load. – An automatic weighing system shall not be used to weigh a load of more than its maximum capacity.

(Amended 2004)

UR.3.3. Special Designs. – An automatic weighing system designed and marked for a special application shall not be used for other than its intended purpose.

UR.3.4. Use of Manual Gross Weight Entries. – Manual entries are permitted only when a device or system is generating labels for standard weight packages.

UR.4. Maintenance Requirements.

UR.4.1. Balance Condition. – If an automatic weighing system is equipped with a zero-load display, the zero-load adjustment of an automatic weighing system shall be maintained so that the device indicates or records a zero balance condition.

UR.4.2. Level Condition. – If an automatic weighing system is equipped with a level-condition indicator, the automatic weighing system shall be maintained in level.

UR.4.3. Automatic Weighing System Modification. – The length or the width of the load-receiving element of an automatic weighing system shall not be increased beyond the manufacturer's design dimension, nor shall the capacity of an automatic weighing system be increased beyond its design capacity by replacing or modifying the original primary indicating or recording element with one of a higher capacity, except when the modification has been approved by competent engineering authority, preferably that of the engineering department of the manufacturer of the automatic weighing system, and by the weights and measures authority having jurisdiction over the automatic weighing system.

THIS PAGE INTENTIONALLY LEFT BLANK

MARKUP COPY

Section 3.30. Liquid-Measuring Devices

A. Application

A.1. General. – This code applies to:

- (a) devices used for the measurement of liquids, including liquid fuels and lubricants; and
- (b) wholesale devices used for the measurement and delivery of agri-chemical liquids such as fertilizers, feeds, herbicides, pesticides, insecticides, fungicides, and defoliant.
(Added 1985)

A.2. Exceptions. – This code does not apply to:

- (a) meters mounted on vehicle tanks (Also see Section 3.31. Code for Vehicle-Tank Meters);
- (b) devices used for dispensing liquefied petroleum gases (Also see Section 3.32. Code for Liquefied Petroleum Gas and Anhydrous Ammonia Liquid-Measuring Devices);
- (c) devices used for dispensing other liquids that do not remain in a liquid state at atmospheric pressures and temperatures;
- (d) water meters;
- (e) devices used solely for dispensing a product in connection with operations in which the amount dispensed does not affect customer charges; or
- (f) mass flow meters. (Also see Section 3.37. Code for Mass Flow Meters.)
(Added 1994)

A.3. Additional Code Requirements. – In addition to the requirements of this code, liquid-measuring devices shall meet the requirements of Section 1.10. General Code.

S. Specifications

S.1. Indicating and Recording Elements and Recorded Representations.

S.1.1. General. – A liquid-measuring device:

- (a) shall be equipped with a primary indicating element; and
- (b) may be equipped with a primary recording element.

S.1.2. Units. – A liquid-measuring device shall indicate, and record if the device is equipped to record, its deliveries in liters, gallons, quarts, pints, fluid ounces, or binary-submultiples or decimal subdivisions of the liter or gallon.

(Amended 1987, 1994, and 2006)

S.1.2.1. Retail Motor-Fuel Devices. – Deliveries shall be indicated and recorded, if the device is equipped to record, in liters or gallons and decimal subdivisions or fractional equivalents thereof.

(Added 1979)

S.1.2.2. Agri-Chemical Liquid Devices.

S.1.2.2.1. Liquid Measure. – Deliveries shall be indicated and recorded in liters or gallons and decimal subdivisions or fractional equivalents thereof.

S.1.2.3. Value of Smallest Unit. – The value of the smallest unit of indicated delivery, and recorded delivery if the device is equipped to record, shall not exceed the equivalent of:

- (a) 0.5 L (0.1 gal) on devices with a maximum rated flow rate of 750 L/min (200 gal/min) or less;
- (b) 5 L (1 gal) on devices with a maximum rated flow of more than 750 L/min (200 gal/min); or
- (c) 5 L (1 gal) on meters with a rated maximum flow rate of 375 L/min (100 gal/min) or more used for jet fuel aviation refueling systems.
(Added 2007)

This requirement does not apply to manually operated devices equipped with stops or stroke-limiting means.

(Amended 1983, 1986, and 2007)

S.1.3. Advancement of Indicating and Recording Elements. – It shall not be possible to advance primary indicating and recording elements except by the mechanical operation of the device. Clearing a device by advancing its elements to zero is permitted, but only if:

- (a) once started, the advancement movement cannot be stopped until zero is reached; and
- (b) in the case of indicating elements only, such elements are automatically obscured until the elements reach the correct zero position.

S.1.4. Graduations.

S.1.4.1. Length. – Graduations shall be varied in length so that they may be conveniently read.

S.1.4.2. Width. – In a series of graduations, the width of:

- (a) every graduation shall be at least 0.2 mm (0.008 in) but not greater than the minimum clear interval between graduations; and
- (b) main graduations shall be not more than 50 % greater than the width of subordinate graduations.

S.1.4.3. Clear Interval Between Graduations. – The clear interval between graduations shall be not less than 1.0 mm (0.04 in). If the graduations are not parallel, the measurement shall be made:

- (a) along the line of movement of the tip of the index of the indicator as it passes over the graduations; or
- (b) if the indicator extends over the entire length of the graduations, at the point of widest separation of the graduations.

S.1.5. Indicators.

S.1.5.1. Symmetry. – The portion of the index of an indicator associated with the graduations shall be symmetrical with respect to the graduations.

S.1.5.2. Length.

- (a) If the indicator and the graduations are in different planes, the index of the indicator shall extend to each graduation with which it is to be used.
- (b) If the indicator is in the same plane as the graduations, the distance between the index of the indicator and the ends of the graduations, measured along the line of the graduations, shall be not more than 1.0 mm (0.04 in).

S.1.5.3. Width.

- (a) *The index of an indicator shall not be wider than the width of the narrowest graduation.*
[Nonretroactive as of January 1, 2002]
(Amended 2000)
- (b) If the index of an indicator extends over the entire length of a graduation, it shall be of uniform width throughout the portion that coincides with the graduation.

S.1.5.4. Clearance. – If the indicator and the graduations are in different planes, the clearance between the index of an indicator and the plane of the graduations shall be no greater than 1.5 mm (0.06 in).

S.1.5.5. Parallax. – Parallax effects shall be reduced to the practical minimum.

S.1.6. Additional Operating Requirements, Retail Devices (Except Slow-flow Meters).

S.1.6.1. Indication of Delivery. – The device shall automatically show on its face the initial zero condition and the quantity delivered (up to the nominal capacity). However, the following requirements shall apply:

For electronic devices manufactured prior to January 1, 2006, the first 0.03 L (or 0.009 gal) of a delivery and its associated total sales price need not be indicated.

For electronic devices manufactured on or after January 1, 2006, the measurement, indication of delivered quantity, and the indication of total sales price shall be inhibited until the fueling position reaches conditions necessary to ensure that the delivery starts at zero.

[Nonretroactive as of January 1, 2006]

(Added 2005)

(Amended 1982 and 2005)

S.1.6.2. Provisions for Power Loss.

S.1.6.2.1. Transaction Information. – *In the event of a power loss, the information needed to complete any transaction in progress at the time of the power loss (such as the quantity and unit price, or sales price) shall be determinable for at least 15 minutes at the dispenser or at the console if the console is accessible to the customer.*

[Nonretroactive as of January 1, 1983]

S.1.6.2.2. User Information. – *The device memory shall retain information on the quantity of fuel dispensed and the sales price totals during power loss.*

[Nonretroactive as of January 1, 1983]

S.1.6.3. Return to Zero.

- (a) The primary indicating elements, and primary recording elements if the device is equipped to record, shall be readily returnable to a definite zero indication. However, a key-lock operated or

other self-operated device may be equipped with cumulative indicating or recording elements, provided that it is also equipped with a zero-return indicating element.

- (b) It shall not be possible to return primary indicating elements, or primary recording elements beyond the correct zero position.

(Amended 1972)

S.1.6.4. Display of Unit Price and Product Identity.

S.1.6.4.1. Unit Price.

- (a) A computing or money-operated device shall be able to display on each face the unit price at which the device is set to compute or to dispense.
- (b) *Except for dispensers used exclusively for fleet sales, other price contract sales, and truck refueling (e.g., truck stop dispensers used only to refuel trucks), whenever a grade, brand, blend, or mixture is offered for sale from a device at more than one unit price, then all of the unit prices at which that product is offered for sale shall meet the following conditions:*
- (1) *For a system that applies a discount prior to the delivery, all unit prices shall be displayed or shall be capable of being displayed on the dispenser ~~to~~ through a deliberate action of the customer prior to the delivery of the product. It is not necessary that all of the unit prices for all grades, brands, blends, or mixtures be simultaneously displayed prior to the delivery of the product.*
[Effective and nonretroactive as of January 1, 1991]
- (2) For a system that offers post-delivery discounts on fuel sales, display of pre-delivery unit price information is exempt from (b)(1), provided the system complies with S.1.6.8. Recorded Representations for Transactions Where a Post-Delivery Discount(s) is Provided.

(Added 2012)

Note: When a product is offered at more than one unit price, display of the unit price information may be through the deliberate action of the customer: 1) using controls on the device; 2) through the customer's use of personal or vehicle-mounted electronic equipment communicating with the system; or 3) verbal instructions by the customer.

(Added 2012)

(Amended 1989, 1997, and 2012)

S.1.6.4.2. Product Identity.

- (a) A device shall be able to conspicuously display on each side the identity of the product being dispensed.
- (b) A device designed to dispense more than one grade, brand, blend, or mixture of product also shall be able to display on each side the identity of the grade, brand, blend, or mixture being dispensed.

S.1.6.5. Money-Value Computations.

(a) *A computing device shall compute the total sales price at any single-purchase unit price (i.e., excluding fleet sales, other price contract sales, and truck stop dispensers used only to refuel trucks) for which the product being measured is offered for sale at any delivery possible within either the measurement range of the device or the range of the computing elements, whichever is less.*

[Effective and Nonretroactive as of January 1, 1991]

(b) The analog sales price indicated for any delivered quantity shall not differ from a mathematically computed price (quantity x unit price = total sales price) by an amount greater than the value in Table 1.

(Amended 1984, 1989, and 1993)

S.1.6.5.1. Money-Value Divisions, Analog. – The values of the graduated intervals representing money values on a computing type device shall be no greater than those in Table 1. Money-Value Divisions and Maximum Allowable Variations for Money-Value Computations on Mechanical Analog Computers.

(Amended 1991)

| Table 1. Money-Value Divisions and Maximum Allowable Variations for Money-Value Computations on Mechanical Analog Computers | | | | |
|--|-----------------------------------|---------------------------------|--|-----------------------|
| Unit Price | | Money-Value Division | Maximum Allowable Variation | |
| From | To and including | | Design Test | Field Test |
| 0 | \$0.25/liter or \$1.00/gallon | 1¢ | ± 1¢ | ± 1¢ |
| \$0.25/liter or \$1.00/gallon | \$0.75/liter or \$3.00/gallon | 1¢ or 2¢ | ± 1¢ | ± 2¢ |
| \$0.75/liter or \$3.00/gallon | \$2.50/liter or \$10.00/gallon | 1¢ or 2¢ | ± 1¢ | ± 2¢ |
| \$0.75/liter or \$3.00/gallon | \$2.50/liter or \$10.00/gallon | 5¢ | ± 2½¢ | ± 5¢ |

S.1.6.5.2. Money-Value Divisions, Digital. – A computing type device with digital indications shall comply with the requirements of paragraph G.S.5.5. Money-Values, Mathematical Agreement, and the total price computation shall be based on quantities not exceeding 0.05 L for devices indicating in metric units and 0.01 gal intervals for devices indicating in inch-pound units.

(Added 1980)

S.1.6.5.3. Auxiliary Elements. – *If a system is equipped with auxiliary indications, all indicated money-value divisions of the auxiliary element shall be identical with those of the primary element.*

[Nonretroactive and enforceable as of January 1, 1985]

S.1.6.5.4. Selection of Unit Price. – A system shall not permit a change to the unit price during delivery of product. When a product or grade is offered for sale at more than one unit price through a computing device, the following conditions shall be met:

Except for a system only capable of applying a post-delivery discount(s), the selection of the unit price shall be made prior to delivery through a deliberate action of the customer to select the unit price for the fuel delivery.

[Nonretroactive as of January 1, 1991]

For a system only capable of applying a post-delivery discount(s), the selection of the unit price shall be made through a deliberate action of the customer to select the unit price for the fuel delivery.

(Added 2012)

Note: When a product is offered at more than one unit price, selection of the unit price may be through the deliberate action of the customer: 1) using controls on the device; 2) through the customer's use of personal or vehicle-mounted electronic equipment communicating with the system; or 3) verbal instructions by the customer.

(Added 2012)

The provisions in (a) and (b) do not apply to dispensers used exclusively for fleet sales, other price contract sales, and truck refueling (e.g., truck stop dispensers used only to refuel trucks).

(Added 1989) (Amended 1991, 1992, 1993, 1996, and 2012)

S.1.6.5.5. Display of Quantity and Total Price. – *Except for aviation refueling applications, when a delivery is completed, the total price and quantity for that transaction shall be displayed on the face of the dispenser for at least 5 minutes or until the next transaction is initiated by using controls on the device or other customer-activated controls.*

[Nonretroactive as of January 1, 1994]

(Added 1992) (Amended 1996 and 2007)

S.1.6.5.6. Display of Quantity and Total Price, Aviation Refueling Applications.

(a) *The quantity shall be displayed throughout the transaction.*

(b) *The total price shall also be displayed under one of the following conditions:*

(1) *The total price can appear on the face of the dispenser or through a controller adjacent to the device.*

(2) *If a device is designed to continuously compute and display the total price, then the total price shall be computed and displayed throughout the transaction for the quantity delivered.*

(c) *The total price and quantity shall be displayed for at least 5 minutes or until the next transaction is initiated by using controls on the device or other customer-activated controls.*

(d) *A printed receipt shall be available and shall include, at a minimum, the total price, quantity, and unit price.*

[Nonretroactive as of January 1, 2008]

(Added 2007)

S.1.6.6. Agreement Between Indications.

- (a) When a quantity value indicated or recorded by an auxiliary element is a derived or computed value based on data received from a retail motor fuel dispenser, the value may differ from the quantity value displayed on the dispenser, provided the following conditions are met:
- (1) all total money-values for an individual sale that are indicated or recorded by the system agree; and
 - (2) *within each element, the values indicated or recorded meet the formula (quantity x unit price = total sales price) to the closest cent.*
[Nonretroactive as of January 1, 1988]
- (b) When a system applies a post-delivery discount(s) to a fuel's unit price through an auxiliary element, the following conditions shall apply for computed values:
- (1) the total volume of the delivery shall be in agreement between all elements in the system.

(Added 2012)

(Added 1985) (Amended 1987, 1988, and 2012)

S.1.6.7. Recorded Representations. – *Except for fleet sales and other price contract sales and for transactions where a post-delivery discount is provided, a printed receipt providing the following information shall be available through a built-in or separate recording element for all transactions conducted with point-of-sale systems or devices activated by debit cards, credit cards, and/or cash:*

- (a) *the total volume of the delivery;*
- (b) *the unit price;*
- (c) *the total computed price; and*
- (d) *the product identity by name, symbol, abbreviation, or code number.*

For systems equipped with the capability to issue an electronic receipt, the customer may be given the option to receive the receipt electronically (e.g., via cell phone, computer, etc.)

[Nonretroactive as of January 1, 1986]

(Added 1985) (Amended 1997 and 2012)

S.1.6.8. Recorded Representations for Transactions Where a Post-Delivery Discount(s) is Provided. – Except for fleet sales and other price contract sales, a printed receipt providing the following information shall be available through a built-in or separate recording element that is part of the system for transactions involving a post-delivery discount:

- (a) the product identity by name, symbol, abbreviation, or code number;
- (b) transaction information as shown on the dispenser at the end of the delivery and prior to any post-delivery discount(s), including the:
 - (1) total volume of the delivery;
 - (2) unit price; and
 - (3) total computed price of the fuel sale.

- (c) an itemization of the post-delivery discounts to the unit price; and
- (d) the final total price of the fuel sale after all post-delivery discounts are applied.

For systems equipped with the capability to issue an electronic receipt, the customer may be given the option to receive the receipt electronically (e.g., via cell phone, computer, etc.).

(Added 2012)

S.1.6.9. Lubricant Devices, Travel of Indicator. – The indicator shall move at least 2.5 cm (1 in) in relation to the graduations, if provided, for a delivery of 0.5 L (1 pt).

S.1.7. Additional Operating Requirements, Wholesale Devices Only.

S.1.7.1. Travel of Indicator. – A wholesale device shall be readily operable to deliver accurately any quantity from 200 L (50 gal) to the capacity of the device. If the most sensitive element of the indicating system utilizes an indicator and graduations, the relative movement of these parts corresponding to a delivery of 4 L (1 gal) shall be not less than 5 mm (0.20 in).

(Amended 1987)

S.1.7.2. Money-Values – Mathematical Agreement. – Any digital money-value indication and any recorded money-value on a computing-type device shall be in mathematical agreement with its associated quantity indication or representation to within 1 cent of money-value.

S.2. Measuring Elements.

S.2.1. Vapor Elimination.

- (a) A liquid-measuring device shall be equipped with a vapor or air eliminator or other automatic means to prevent the passage of vapor and air through the meter.
- (b) Vent lines from the air or vapor eliminator shall be made of metal tubing or other rigid material.

(Amended 1975)

S.2.1.1. Vapor Elimination on Loading Rack Metering Systems.

- (a) A loading rack metering system shall be equipped with a vapor or air eliminator or other automatic means to prevent the passage of vapor and air through the meter unless the system is designed or operationally controlled by a method, approved by the weights and measures jurisdiction having control over the device, such that air and/or vapor cannot enter the system.
- (b) Vent lines from the air or vapor eliminator (if present) shall be made of metal tubing or other rigid material.

(Added 1994)

S.2.2. Provision for Sealing. – Adequate provision shall be made for an approved means of security (e.g., data change audit trail) or for physically applying a security seal in such a manner that requires the security seal to be broken before an adjustment or interchange can be made of:

- (a) any measuring or indicating element;
- (b) any adjustable element for controlling delivery rate when such rate tends to affect the accuracy of deliveries; and
- (c) any metrological parameter that will affect the metrological integrity of the device or system.

When applicable, the adjusting mechanism shall be readily accessible for purposes of affixing a security seal.

*[Audit trails shall use the format set forth in Table S.2.2.]**

*[*Nonretroactive and enforceable as of January 1, 1995]*

(Amended 1991, 1993, 1995, and 2006)

| Table S.2.2. Categories of Device and Methods of Sealing | |
|--|---|
| <i>Categories of Device</i> | <i>Methods of Sealing</i> |
| Category 1: <i>No remote configuration capability.</i> | <i>Seal by physical seal or two event counters: one for calibration parameters and one for configuration parameters.</i> |
| Category 2: <i>Remote configuration capability, but access is controlled by physical hardware.</i> <i>The device shall clearly indicate that it is in the remote configuration mode and record such message if capable of printing in this mode or shall not operate while in this mode.</i> | <i>[The hardware enabling access for remote communication must be on-site. The hardware must be sealed using a physical seal or an event counter for calibration parameters and an event counter for configuration parameters. The event counters may be located either at the individual measuring device or at the system controller; however, an adequate number of counters must be provided to monitor the calibration and configuration parameters of the individual devices at a location. If the counters are located in the system controller rather than at the individual device, means must be provided to generate a hard copy of the information through an on-site device.]*</i> <i>[*Nonretroactive as of January 1, 1996]</i> |
| Category 3: <i>Remote configuration capability access may be unlimited or controlled through a software switch (e.g., password).</i> <i>[Nonretroactive as of January 1, 1995]</i> <i>The device shall clearly indicate that it is in the remote configuration mode and record such message if capable of printing in this mode or shall not operate while in this mode.</i> <i>[Nonretroactive as of January 1, 2001]</i> | <i>An event logger is required in the device; it must include an event counter (000 to 999), the parameter ID, the date and time of the change, and the new value of the parameter. A printed copy of the information must be available through the device or through another on-site device. The event logger shall have a capacity to retain records equal to 10 times the number of sealable parameters in the device, but not more than 1000 records are required. (Note: Does not require 1000 changes to be stored for each parameter.)</i> |

[Nonretroactive as of January 1, 1995]

(Table Added 1993) (Amended 1995, 1998, 1999, and 2006)

S.2.3. Directional Flow Valves. – Valves intended to prevent reversal of flow shall be automatic in operation.

S.2.4. Stop Mechanism.

S.2.4.1. Indication. – The delivery for which the device is set shall be conspicuously indicated.

(Amended 1983)

S.2.4.2. Stroke Limiting Elements. – Stops or other stroke limiting elements subject to direct pressure or impact shall be:

- (a) made secure by positive, nonfrictional engagement of these elements; and
- (b) adjustable to provide for deliveries within tolerances.

(Amended 1983)

S.2.4.3. Setting. – If two or more stops or other elements may be selectively brought into operation to permit predetermined quantities of deliveries:

- (a) the position for the proper setting of each such element shall be accurately defined; and
- (b) any inadvertent displacement from the proper setting shall be obstructed.

(Amended 1983)

S.2.5. Zero-Set-Back Interlock, Retail Motor-Fuel Devices. – A device shall be constructed so that:

- (a) after a delivery cycle has been completed by moving the starting lever to any position that shuts off the device, an automatic interlock prevents a subsequent delivery until the indicating elements, and recording elements if the device is equipped and activated to record, have been returned to their zero positions;
- (b) the discharge nozzle cannot be returned to its designed hanging position (that is, any position where the tip of the nozzle is placed in its designed receptacle and the lock can be inserted) until the starting lever is in its designed shut-off position and the zero-set-back interlock has been engaged; and
- (c) in a system with more than one dispenser supplied by a single pump, an effective automatic control valve in each dispenser prevents product from being delivered until the indicating elements on that dispenser are in a correct zero position.

(Amended 1981 and 1985)

S.2.6. Temperature Determination – Wholesale Devices. – *For test purposes, means shall be provided (e.g., thermometer well) to determine the temperature of the liquid either:*

- (a) *in the liquid chamber of the meter; or*
- (b) *in the meter inlet or discharge line immediately adjacent to the meter.*

[Nonretroactive as of January 1, 1985]

(Added 1984) (Amended 1986)

S.2.7. Wholesale Devices Equipped with Automatic Temperature Compensators.

S.2.7.1. Automatic Temperature Compensation. – A device may be equipped with an automatic means for adjusting the indication and registration of the measured volume of product to the volume at 15 °C (60 °F).

S.2.7.2. Provision for Deactivating. – On a device equipped with an automatic temperature-compensating mechanism that will indicate or record only in terms of gallons compensated to 15 °C (60 °F), provision shall be made for deactivating the automatic temperature-compensating mechanism so that the meter can indicate and record, if it is equipped to record, in terms of the uncompensated volume.

(Amended 1972)

S.2.7.3. Provision for Sealing Automatic Temperature-Compensating Systems. – Provision shall be made for applying security seals in such a manner that an automatic temperature-compensating system cannot be disconnected and that no adjustment may be made to the system without breaking the seal.

S.2.7.4. Temperature Determination with Automatic Temperature-Compensation. – For test purposes, means shall be provided (e.g., thermometer well) to determine the temperature of the liquid either:

- (a) in the liquid chamber of the meter; or
- (b) immediately adjacent to the meter in the meter inlet or discharge line.

(Amended 1987)

S.2.8. Exhaustion of Supply, Lubricant Devices Other than Meter Types. – When the level of the supply of lubricant becomes so low as to compromise the accuracy of measurement, the device shall:

- (a) automatically become inoperable; or
- (b) give a conspicuous and distinct warning.

S.3. Discharge Lines and Valves.

S.3.1. Diversion of Measured Liquid. – No means shall be provided by which any measured liquid can be diverted from the measuring chamber of the meter or its discharge line. Two or more delivery outlets may be installed only if automatic means are provided to ensure that:

- (a) liquid can flow from only one outlet at a time; and
- (b) the direction of flow for which the mechanism may be set at any time is clearly and conspicuously indicated.

An outlet that may be opened for purging or draining the measuring system or for recirculating, if recirculation is required in order to maintain the product in a deliverable state, shall be permitted only when the system is measuring food products, agri-chemicals, biodiesel, or biodiesel blends. Effective automatic means shall be provided to prevent passage of liquid through any such outlet during normal operation of the measuring system and to inhibit meter indications (or advancement of indications) and recorded representations while the outlet is in operation.

(Amended 1991, 1995, 1996, and 2007)

S.3.2. Exceptions. – The provisions of S.3.1. Diversion of Measured Liquid shall not apply to truck refueling devices when diversion of flow to other than the receiving vehicle cannot readily be accomplished and is readily apparent. Allowable deterrents include, but are not limited to, physical barriers to adjacent driveways, visible valves, or lighting systems that indicate which outlets are in operation, and explanatory signs.

(Amended 1982, 1990, 1991, and 2002)

S.3.3. Pump-Discharge Unit. – A pump-discharge unit equipped with a flexible discharge hose shall be of the wet-hose type.

S.3.4. Gravity-Discharge Unit. – On a gravity-discharge unit:

- (a) the discharge hose or equivalent pipe shall be of the dry-hose type with no shutoff valve at its outlet end unless the hose or pipe drains to the same level under all conditions of use;
- (b) the dry-hose shall be sufficiently stiff and only as long as necessary to facilitate drainage;

- (c) an automatic vacuum breaker, or equivalent mechanism, shall be incorporated to prevent siphoning and to ensure rapid and complete drainage; and
- (d) the inlet end of the hose or outlet pipe shall be high enough to ensure complete drainage.

S.3.5. Discharge Hose, Reinforcement. – A discharge hose shall be reinforced so that the performance of the device is not affected by the expansion or contraction of the hose.

S.3.6. Discharge Valve. – A discharge valve may be installed in the discharge line only if the device is of the wet-hose type. Any other shutoff valve on the discharge side of the meter shall be of the automatic or semiautomatic predetermined-stop type or shall be operable only:

- (a) by means of a tool (but not a pin) entirely separate from the device; or
- (b) by mutilation of a security seal with which the valve is sealed open.

S.3.7. Anti-drain Means. – In a wet-hose pressure-type device, means shall be incorporated to prevent the drainage of the discharge hose.

(Amended 1990)

S.4. Marking Requirements.

S.4.1. Limitation on Use. – The limitations on its use shall be clearly and permanently marked on any device intended to measure accurately only:

- (a) products having particular properties;
- (b) under specific installation or operating conditions; or
- (c) when used in conjunction with specific accessory equipment.

S.4.2. Air Pressure. – If a device is operated by air pressure, the air pressure gauge shall show by special graduations or other means the maximum and minimum working pressures recommended by the manufacturer.

S.4.3. Wholesale Devices.

S.4.3.1. Discharge Rates. – A wholesale device shall be marked to show its designed maximum and minimum discharge rates. However, the minimum discharge rate shall not exceed 20 % of the maximum discharge rate.

S.4.3.2. Temperature Compensation. – If a device is equipped with an automatic temperature compensation, the primary indicating elements, recording elements, and recorded representation shall be clearly and conspicuously marked to show that the volume delivered has been adjusted to the volume at 15 °C (60 °F).

S.4.4. Retail Devices.

S.4.4.1. Discharge Rates. – *On a retail device with a designed maximum discharge rate of 115 L (30 gal) per minute or greater, the maximum and minimum discharge rates shall be marked in accordance with S.4.4.2. Location of Marking Information; Retail Motor-Fuel Dispensers. The marked minimum discharge rate shall not exceed 20 % of the marked maximum discharge rate.*

[Nonretroactive as of January 1, 1985]

(Added 1984) (Amended 2003)

Example: With a marked maximum discharge rate of 230 L/min (60 gpm), the marked minimum discharge rate shall be 45 L/min (12 gpm) or less (e.g., 40 L/min [10 gpm] is acceptable). A marked minimum discharge rate greater than 45 L/min (12 gpm) (e.g., 60 L/min [15 gpm]) is not acceptable.

S.4.4.2. Location of Marking Information; Retail Motor-Fuel Dispensers. – *The marking information required in the General Code, paragraph G-S.1. Identification shall appear as follows:*

- (a) *within 60 cm (24 in) to 150 cm (60 in) from the base of the dispenser;*
- (b) *either internally and/or externally provided the information is permanent and easily read; and*
- (c) *on a portion of the device that cannot be readily removed or interchanged (i.e., not on a service access panel).*

Note: *The use of a dispenser key or tool to access internal marking information is permitted for retail liquid-measuring devices.*

[Nonretroactive as of January 1, 2003]

(Added 2002) (Amended 2004)

S.5. Totalizers for Retail Motor-Fuel Dispensers. – *Retail motor-fuel dispensers shall be equipped with a non-resettable totalizer for the quantity delivered through the metering device.*

[Nonretroactive as of January 1, 1995]

(Added 1993) (Amended 1994)

N. Notes

N.1. Test Liquid.

N.1.1. Type of Liquid. – The liquid used for testing a liquid-measuring device shall be the type the device is used to measure, or another liquid with the same general physical characteristics.

N.1.2. Labeling. – Following the completion of a successful examination of a wholesale device, the weights and measures official should attach a label or tag indicating the type of liquid used during the test.

N.2. Volume Change. – Care shall be taken to minimize changes in volume of the test liquid due to temperature changes and evaporation losses.

N.3. Test Drafts.

N.3.1. Retail Piston-Type and Visible-Type Devices. – Test drafts shall include the full capacity delivery and each intermediate delivery for which the device is designed.

N.3.2. Slow-flow Meters. – Test drafts shall be equal to at least four times the minimum volume that can be measured and indicated through either a visible indication or an audible signal.

N.3.3. Lubricant Devices. – Test drafts shall be 1 L (1 qt). Additional test drafts may include 0.5 L (1 pt), 4 L (4 qt), and 6 L (6 qt).

N.3.4. Other Retail Devices. – On devices with a designed maximum discharge rate of:

- (a) less than 80 L (20 gal) per minute, tests shall include drafts of one or more amounts, including a draft of at least 19 L (5 gal).

- (b) 80 L (20 gal) per minute or greater, tests shall include drafts of one or more amounts, including a draft of at least the amount delivered by the device in 1 minute at the maximum flow rate of the installation.

(Amended 1984)

N.3.5. Wholesale Devices. – The delivered quantity should be equal to at least the amount delivered by the device in 1 minute at its maximum discharge rate, and shall in no case be less than 200 L (50 gal).

(Amended 1987 and 1996)

N.4. Testing Procedures.

N.4.1. Normal Tests. – The “normal” test of a device shall be made at the maximum discharge flow rate developed under the conditions of installation. Any additional tests conducted at flow rates down to and including one-half of the sum of the maximum discharge flow rate and the rated minimum discharge flow rate shall be considered normal tests.

(Amended 1991)

N.4.1.1. Wholesale Devices Equipped with Automatic Temperature-Compensating Systems. – On wholesale devices equipped with automatic temperature-compensating systems, normal tests shall be conducted:

- (a) by comparing the compensated volume indicated or recorded to the actual delivered volume corrected to 15 °C (60 °F); and
- (b) with the temperature-compensating system deactivated, comparing the uncompensated volume indicated or recorded to the actual delivered volume.

The first test shall be performed with the automatic temperature-compensating system operating in the “as found” condition.

On devices that indicate or record both the compensated and uncompensated volume for each delivery, the tests in (a) and (b) may be performed as a single test.

(Amended 1987)

N.4.1.2. Repeatability Tests. – Tests for repeatability should include a minimum of three consecutive test drafts of approximately the same size and be conducted under controlled conditions where variations in factors such as temperature, pressure, and flow rate are reduced to the extent that they will not affect the results obtained.

(Added 2001)

N.4.2. Special Tests. – “Special” tests shall be made to develop the operating characteristics of a device and any special elements and accessories attached to or associated with the device. Any test except as set forth in N.4.1. Normal Tests shall be considered a special test.

N.4.2.1. Slow-Flow Meters. – A “special” test shall be made at a flow rate:

- (a) not larger than twice the actual minimum flow rate; and
- (b) not smaller than the actual minimum flow rate of the installation.

N.4.2.2. Retail Motor-Fuel Devices.

- (a) Devices without a marked minimum flow-rate shall have a “special” test performed at the slower of the following rates:

- (1) 19 L (5 gal) per minute; or

(2) the minimum discharge rate at which the device will deliver when equipped with an automatic discharge nozzle set at its slowest setting.

(b) Devices with a marked minimum flow-rate shall have a “special” test performed at or near the marked minimum flow rate.

(Added 1984) (Amended 2005)

N.4.2.3. Other Retail Devices. – “Special” tests of other retail devices shall be made at the slower of the following rates:

(a) 50 % of the maximum discharge rate developed under the conditions of installation; or

(b) the minimum discharge rate marked on the device.

N.4.2.4. Wholesale Devices. – “Special” tests shall be made to develop the operating characteristics of a measuring system and any special associated or attached elements and accessories. “Special” tests shall include a test at the slower of the following rates:

(a) 20 % of the marked maximum discharge rate; or

(b) the minimum discharge rate marked on the device.

N.4.3. Money-Value Computation Tests.

N.4.3.1. Laboratory Tests. – When testing the device in the laboratory:

(a) compliance with paragraph S.1.6.5. Money-Value Computations, shall be determined by using the cone gear as a reference for the total quantity delivered;

(b) the indicated quantity shall agree with the cone gear representation with the index of the indicator within the width of the graduation; and

(c) the maximum allowable variation of the indicated sales price shall be as shown in Table 1. Money-Value Divisions and Maximum Allowable Variations for Money-Value Computations on Mechanical Analog Computers.

(Amended 1984)

N.4.3.2. Field Tests. – In the conduct of field tests to determine compliance with paragraph S.1.6.5. Money-Value Computations, the maximum allowable variation in the indicated sales price shall be as shown in Table 1.

(Added 1982) (Amended 1984)

N.4.4. Pour and Drain Times.

N.4.4.1. Pour and Drain Times for Hand-held Test Measures. – Hand-held test measures require a 30-second (± 5 seconds) pour followed by a 10-second drain with the measure held at a 10-degree to 15-degree angle from vertical.

N.4.4.2. Drain Times for Bottom Drain Test Measures or Provers. – Bottom drain field standard provers require a 30-second drain time after main flow cessation.

(Added 2009)

N.5. Temperature Correction on Wholesale Devices. – Corrections shall be made for any changes in volume resulting from the differences in liquid temperatures between time of passage through the meter and time of volumetric determination in the prover. When adjustments are necessary, appropriate petroleum measurement tables should be used.

(Amended 1974)

T. Tolerances

T.1. Application to Underregistration and to Overregistration. – The tolerances hereinafter prescribed shall be applied to errors of underregistration and errors of overregistration, whether or not a device is equipped with an automatic temperature compensator.

T.2. Tolerance Values. – Maintenance, acceptance, and special test tolerances shall be as shown in Table T.2. Accuracy Classes and Tolerances for Liquid Measuring Devices Covered in NIST Handbook 44, Section 3.30.

MARKUP COPY

| Accuracy Class | Application | Acceptance Tolerance | Maintenance Tolerance | Special Test Tolerance ¹ |
|----------------|---|----------------------|-----------------------|-------------------------------------|
| 0.3 | <ul style="list-style-type: none"> - Petroleum products delivered from large capacity (flow rates greater than 115 L/min or 30 gpm)** devices, including motor-fuel devices - Heated products (other than asphalt) at <u>temperatures greater than 50 °C (122 °F)</u> - Asphalt at <u>temperatures equal to or below a temperature of 50 °C (122 °F)</u> - All other liquids not shown in the table where the typical delivery is over 200 L (50 gal) | 0.2 % | 0.3 % | 0.5 % |
| 0.3A | <ul style="list-style-type: none"> - Asphalt at temperatures greater than 50 °C (122 °F) | 0.3 % | 0.3 % | 0.5 % |
| 0.5* | <ul style="list-style-type: none"> - Petroleum products delivered from small capacity (at 4 L/min (1 gpm) through 115 L/min or 30 gpm)** motor-fuel devices - Agri-chemical liquids - All other applications not shown in the table where the typical delivery is ≤ 200 L (50 gal) | 0.3 % | 0.5 % | 0.5 % |
| 1.1 | <ul style="list-style-type: none"> - Petroleum products and other normal liquids from devices with flow rates** less than 1 gpm. - Devices designed to deliver less than 1 gal | 0.75 % | 1.0 % | 1.25 % |

* For test drafts ≤ 40 L or 10 gal, the tolerances specified for Accuracy Class 0.5 in the table above do not apply. For these test drafts, the following applies:

(a) Maintenance tolerances on normal and special tests shall be 20 mL plus 4 mL per indicated liter or 1 in³ plus 1 in³ per indicated gallon.

(b) Acceptance tolerances on normal and special tests shall be one-half the maintenance tolerance values.

¹ Special test tolerances are not applicable to retail motor fuel dispensers.

** Flow rate refers to designed or marked maximum flow rate.

(Added 2002) (Amended 2006 and 2013)

T.3. Repeatability. – When multiple tests are conducted at approximately the same flow rate and draft size, the range of the test results for the flow rate shall not exceed 40 % of the absolute value of the maintenance tolerance and the results of each test shall be within the applicable tolerance. This tolerance does not apply to the test of the automatic temperature-compensating system. **See (Also see also N.4.1.2. Repeatability Tests.)**

(Added 1992) (Amended 2001 and 2002)

T.4. Automatic Temperature-Compensating Systems. – The difference between the meter error (expressed as a percentage) for results determined with and without the automatic temperature-compensating system activated shall not exceed:

- (a) 0.2 % for mechanical automatic temperature-compensating systems; and
- (b) 0.1 % for electronic automatic temperature-compensating systems.

The delivered quantities for each test shall be approximately the same size. The results of each test shall be within the applicable acceptance or maintenance tolerance.

[Nonretroactive as of January 1, 1988]

(Added 1987) (Amended 1992, 1996, and 2002)

UR. User Requirements

UR.1. Selection Requirements.

UR.1.1. Discharge Hose.

UR.1.1.1. Length. – The length of the discharge hose on a retail motor-fuel device:

- (a) shall be measured from its housing or outlet of the discharge line to the inlet of the discharge nozzle;
- (b) shall be measured with the hose fully extended if it is coiled or otherwise retained or connected inside a housing; and
- (c) shall not exceed 5.5 m (18 ft) unless it can be demonstrated that a longer hose is essential to permit deliveries to be made to receiving vehicles or vessels.

An unnecessarily remote location of a device shall not be accepted as justification for an abnormally long hose.

(Amended 1972 and 1987)

UR.1.1.2. Marinas and Airports.

UR.1.1.2.1. Length. – The length of the discharge hose shall be as short as practicable, and shall not exceed 15 m (50 ft) unless it can be demonstrated that a longer hose is essential.

UR.1.1.2.2. Protection. – Discharge hoses exceeding 8 m (26 ft) in length shall be adequately protected from weather and other environmental factors when not in use.

(Made retroactive 1974 and Amended 1984)

UR.2. Installation Requirements.

UR.2.1. Manufacturer's Instructions. – A device shall be installed in accordance with the manufacturer's instructions, and the installation shall be sufficiently secure and rigid to maintain this condition.

(Added 1987)

UR.2.2. Discharge Rate. – A device shall be installed so that the actual maximum discharge rate will not exceed the rated maximum discharge rate. Automatic means for flow regulation shall be incorporated in the installation if necessary.

UR.2.3. Suction Head. – A piston-type device shall be installed so that the total effective suction head will not be great enough to cause vaporization of the liquid being dispensed under the highest temperature and lowest barometric pressure likely to occur.

UR.2.4. Diversion of Liquid Flow. – A motor-fuel device equipped with two delivery outlets used exclusively in the fueling of trucks shall be so installed that any diversion of flow to other than the receiving vehicle cannot be readily accomplished and is readily apparent. Allowable deterrents include, but are not limited to, physical barriers to adjacent driveways, visible valves, or lighting systems that indicate which outlets are in operation, and explanatory signs.

(Amended 1991)

UR.2.5. Product Storage Identification.

(a) The fill connection for any petroleum product storage tank or vessel supplying motor-fuel devices shall be permanently, plainly, and visibly marked as to product contained.

(b) When the fill connection device is marked by means of a color code, the color code key shall be conspicuously displayed at the place of business.

(Added 1975) (Amended 1976)

UR.3. Use of Device.

UR.3.1. Return of Indicating and Recording Elements to Zero. – On any dispenser used in making retail deliveries, the primary indicating element, and recording element if so equipped, shall be returned to zero before each delivery.

Exceptions to this requirement are totalizers on key-lock-operated or other self-operated dispensers and the primary recording element if the device is equipped to record.

UR.3.2. Unit Price and Product Identity.

(a) The following information shall be conspicuously displayed or posted on the face of a retail dispenser used in direct sale:

(1) except for unit prices resulting from any post-delivery discount and dispensers used exclusively for fleet sales, other price contract sales, and truck refueling (e.g., truck stop dispensers used only to refuel trucks), all of the unit prices at which the product is offered for sale; and

(2) in the case of a computing type or money-operated type, the unit price at which the dispenser is set to compute.

Provided that the dispenser complies with S.1.6.4.1. Display of Unit Price, it is not necessary that all the unit prices for all grades, brands, blends, or mixtures be simultaneously displayed or posted.

(b) The following information shall be conspicuously displayed or posted on each side of a retail dispenser used in direct sale:

(1) the identity of the product in descriptive commercial terms; and

(2) the identity of the grade, brand, blend, or mixture that a multi-product dispenser is set to deliver.

(Amended 1972, 1983, 1987, 1989, 1992, 1993, and 2012)

UR.3.3. Computing Device. – Any computing device used in an application where a product or grade is offered for sale at one or more unit prices shall be used only for sales for which the device computes and displays the sales price for the selected transaction.

(Added 1989) (Amended 1992)

The following exceptions apply:

- (a) Fleet sales and other price contract sales are exempt from this requirement.
- (b) A truck stop dispenser used exclusively for refueling trucks is exempt from this requirement provided that:
 - (1) all purchases of fuel are accompanied by a printed receipt of the transaction containing the applicable price per gallon, the total gallons delivered, and the total price of the sale; and
(Added 1993)
 - (2) unless a dispenser complies with S.1.6.4.1. Display of Unit Price, the price posted on the dispenser and the price at which the dispenser is set to compute shall be the highest price for any transaction which may be conducted.
(Added 1993)
- (c) A dispenser used in an application where a price per unit discount is offered following the delivery is exempt from this requirement, provided the following conditions are satisfied:
 - (1) the unit price posted on the dispenser and the unit price at which the dispenser is set to compute shall be the highest unit price for any transaction;
 - (2) all purchases of fuel are accompanied by a printed receipt recorded by the system for the transaction containing:
 - a. the product identity by name, symbol, abbreviation, or code number;
 - b. transaction information as shown on the dispenser at the end of the delivery and prior to any post-delivery discount including the:
 - 1. total volume of the delivery;
 - 2. unit price; and
 - 3. total computed price of the fuel sale prior to post-delivery discounts being applied.
 - c. an itemization of the post-delivery discounts to the unit price; and
 - d. the final total price of the fuel sale.

For systems equipped with the capability to issue an electronic receipt, the customer may be given the option to receive the receipt electronically (e.g., via cell phone, computer, etc.)

(Added 2012)

(Added 1998) (Amended 1992, 1993, and 2012)

UR.3.4. Printed Ticket. – The total price, the total volume of the delivery, and the price per liter or gallon shall be shown, either printed by the device or in clear hand script, on any printed ticket issued by a device and containing any one of these values.

(Amended 2001)

UR.3.5. Steps after Dispensing. – After delivery to a customer from a retail motor-fuel device:

- (a) the starting lever shall be returned to its shutoff position and the zero-set-back interlock engaged; and

- (b) the discharge nozzle shall be returned to its designed hanging position unless the primary indicating elements, and recording elements, if the device is equipped and activated to record, have been returned to a definite zero indication.

UR.3.6. Temperature Compensation, Wholesale.

UR.3.6.1. Automatic.

UR.3.6.1.1. When to be Used. – If a device is equipped with a mechanical automatic temperature compensator, it shall be connected, operable, and in use at all times. An electronic or mechanical automatic temperature-compensating system may not be removed, nor may a compensated device be replaced with an uncompensated device, without the written approval of the responsible weights and measures jurisdiction.

Note: This requirement does not specify the method of sale for product measured through a meter.
(Amended 1989)

UR.3.6.1.2. Invoices.

- (a) A written invoice based on a reading of a device that is equipped with an automatic temperature compensator shall show that the volume delivered has been adjusted to the volume at 15 °C (60 °F).
- (b) The invoice issued from an electronic wholesale device equipped with an automatic temperature-compensating system shall also indicate: (1) the API gravity, specific gravity or coefficient of expansion for the product; (2) product temperature; and (3) gross reading.

(Amended 1987)

UR.3.6.2. Nonautomatic.

UR.3.6.2.1. Temperature Determination. – If the volume of the product delivered is adjusted to the volume at 15 °C (60 °F), the product temperature shall be taken during the delivery in:

- (a) the liquid chamber of the meter; or
- (b) the meter inlet or discharge line adjacent to the meter; or
- (c) the compartment of the receiving vehicle at the time it is loaded.

UR.3.6.2.2. Invoices. – The accompanying invoice shall indicate that the volume of the product has been adjusted for temperature variations to a volume at 15 °C (60 °F) and shall also state the product temperature used in making the adjustment.

UR.3.6.3. Period of Use. – When fuel is bought or sold on an automatic or non-automatic temperature-compensated basis, it shall be bought or sold using this method over at least a consecutive 12-month period, unless otherwise agreed to by both the buyer and seller in writing.

(Added 2003)

THIS PAGE INTENTIONALLY LEFT BLANK

MARKUP COPY

Section 3.31. Vehicle-Tank Meters

A. Application

A.1. General. – This code applies to meters mounted on vehicle tanks including those used for the measurement and delivery of petroleum products or agri-chemical liquids such as fertilizers, feeds, pesticides, defoliants, and bulk deliveries of water.

(Amended 1985 and 1995)

A.2. Exceptions. – This code does not apply to the following devices:

- (a) Devices used for dispensing liquefied petroleum gases (~~see Section 3.32. Code for Liquefied Petroleum Gas and Anhydrous Ammonia Liquid-Measuring Devices~~), or other liquids that do not remain in a liquid state at atmospheric pressures and temperatures. (Also see Section 3.32. Code for Liquefied Petroleum Gas and Anhydrous Ammonia Liquid-Measuring Devices.)
- (b) Devices used solely for dispensing a product in connection with operations in which the amount dispensed does not affect customer charges.
- (c) Vehicle tanks used as measures ~~(. (Also see Section 4.40. Code for Vehicle Tanks Used as Measures).)~~
- (d) Mass flow meters ~~(. (Also see Section 3.37. Code for Mass Flow Meters).)~~
(Added 1994)
- (e) Devices used to measure cryogenic liquids ~~(. (Also see Section 3.34. Code for Cryogenic Liquid-Measuring Devices).)~~
- (f) Devices used to measure carbon dioxide liquids ~~(. (Also see Section 3.38. Code for Carbon Dioxide Liquid-Measuring Devices).)~~

A.3. Additional Code Requirements. – In addition to the requirements of this code, Vehicle-Tank Meters shall meet the requirements of 1.10. General Code requirements.

S. Specifications

S.1. Design of Indicating and Recording Elements and of Recorded Representations.

S.1.1. Primary Elements.

S.1.1.1. General. – A meter shall be equipped with a primary indicating element and may also be equipped with a primary recording element.

Note: Except for systems used solely for the sale of aviation fuel into aircraft and for aircraft-related operations, vehicle-tank meters shall be equipped with a primary recording element as required by paragraph UR.2.2. Ticket Printer; Customer Ticket.

(Amended 1993)

S.1.1.2. Units.

- (a) A meter shall indicate, and record if the meter is equipped to record, its deliveries in terms of liters or gallons. Fractional parts of the liter or gallon shall be in terms of either decimal or binary subdivisions.

- (b) When it is an industry practice to purchase and sell milk by weight based upon 1.03 kg/L (8.6 lb/gal), the primary indicating element may indicate in kilograms or pounds and decimal kilograms or pounds. The weight value division shall be a decimal multiple or submultiple of 1, 2, or 5 ~~€~~. (Also see Section S.5.5. Conversion Factor.)

S.1.1.3. Value of Smallest Unit. – The value of the smallest unit of indicated delivery, and recorded delivery if the meter is equipped to record, shall not exceed the equivalent of:

- (a) 0.5 L (0.1 gal) or 0.5 kg (1 lb) on milk-metering systems;
- (b) 0.5 L (0.1 gal) on meters with a rated maximum flow rate of 750 L/min (200 gal/min) or less;
- (c) 5 L (1 gal) on meters with a rated maximum flow of 375 L/min (100 gal/min) or more used for jet fuel aviation refueling systems; or
(Added 2006)
- (d) 5 L (1 gal) on other meters.

(Amended 1989, 1994 and 2006)

S.1.1.4. Advancement of Indicating and Recording Elements. – Primary indicating and recording elements shall be susceptible to advancement only by the mechanical operation of the meter. However, a meter may be cleared by advancing its elements to zero, but only if:

- (a) the advancing movement, once started, cannot be stopped until zero is reached; or
- (b) in the case of indicating elements only, such elements are automatically obscured until the elements reach the correct zero position.

S.1.1.5. Return to Zero. – Primary indicating elements shall be readily returnable to a definite zero indication. Means shall be provided to prevent the return of primary indicating elements, and of primary recording elements if these are returnable to zero, beyond their correct zero position.

S.1.2. Graduations.

S.1.2.1. Length. – Graduations shall be so varied in length that they may be conveniently read.

S.1.2.2. Width. – In any series of graduations, the width of a graduation shall in no case be greater than the width of the minimum clear interval between graduations, and the width of main graduations shall be not more than 50 % greater than the width of subordinate graduations. Graduations shall in no case be less than 0.2 mm (0.008 in) wide.

S.1.2.3. Clear Interval Between Graduations. – The clear interval shall be not less than 2.5 mm (0.10 in). If the graduations are not parallel, the measurement shall be made:

- (a) along the line of relative movement between the graduations at the end of the indicator; or
- (b) if the indicator is continuous, at the point of widest separation of the graduations.

(Amended 1986)

S.1.3. Indicators.

S.1.3.1. Symmetry. – The index of an indicator shall be symmetrical with respect to the graduations at least throughout that portion of its length associated with the graduations.

S.1.3.2. Length. – The index of an indicator shall reach to the finest graduations with which it is used, unless the indicator and the graduations are in the same plane, in which case the distance between the end of the indicator and the ends of the graduations, measured along the line of the graduations, shall be not more than 1.0 mm (0.04 in).

S.1.3.3. Width. – The width of the index of an indicator in relation to the series of graduations with which it is used shall be not greater than:

(a) *the width of the narrowest graduation;* and*
[*Nonretroactive as of January 1, 2002]
(Amended 2001)

(b) the width of the minimum clear interval between graduations.

When the index of an indicator extends along the entire length of a graduation, that portion of the index of the indicator that may be brought into coincidence with the graduation shall be of the same width throughout the length of the index that coincides with the graduation.

S.1.3.4. Clearance. – The clearance between the index of an indicator and the graduations shall in no case be more than 1.5 mm (0.06 in).

S.1.3.5. Parallax. – Parallax effects shall be reduced to the practicable minimum.

S.1.3.6. Travel of Indicator. – If the most sensitive element of the primary indicating element utilizes an indicator and graduations, the relative movement of these parts corresponding to the smallest indicated value shall not be less than 5 mm (0.20 in).

S.1.4. Computing-Type Device.

S.1.4.1. Display of Unit Price. – In a device of the computing type, means shall be provided for displaying, in a manner clear to the operator and an observer, the unit price at which the device is set to compute. The unit price is not required to be displayed continuously.
(Amended 1983 and 2005)

S.1.4.2. Printed Ticket. – If a computing-type device issues a printed ticket which displays the total computed price, the ticket shall also have printed clearly thereon the total quantity of the delivery, the appropriate fraction of the quantity, and the price per unit of quantity.
(Amended 1989)

S.1.4.3. Money-Value Computations. – Money-value computations shall be of the full-computing type in which the money-value at a single unit price, or at each of a series of unit prices, shall be computed for every delivery within either the range of measurement of the device or the range of the computing elements, whichever is less. Value graduations shall be supplied and shall be accurately positioned. The value of each graduated interval shall be ±one cent. On electronic devices with digital indications, the total price may be computed on the basis of the quantity indicated when the value of the smallest division indicated is equal to or less than 0.2 L (0.1 gal) or 0.2 kg (1 lb).
(Amended 1979 and 1989)

S.1.4.4. Money-Values, Mathematical Agreement. – Any digital money-value indication and any recorded money-value on a computing-type device shall be in mathematical agreement with its associated quantity indication or representation to within ±one cent of money-value.

S.2. Design of Measuring Elements.

S.2.1. Vapor Elimination. – A metering system shall be equipped with an effective vapor or air eliminator or other automatic means to prevent the passage of vapor and air through the meter. Vent lines from the air or vapor eliminator shall be made of metal tubing or some other suitable rigid material.

(Amended 1993)

S.2.2. Provision for Sealing. – Adequate provision shall be made for an approved means of security (e.g., data change audit trail) or for physically applying a security seal in such a manner that requires the security seal to be broken before a change or an adjustment or interchange may be made of:

- (a) any measuring or indicating element;
- (b) any adjustable element for controlling delivery rate when such rate tends to affect the accuracy of deliveries; and
- (c) any metrological parameter that will affect the metrological integrity of the device or system.

When applicable, the adjusting mechanism shall be readily accessible for purposes of affixing a security seal.

*[Audit trails shall use the format set forth in Table S.2.2. Categories of Device and Methods Sealing.]**

*[*Nonretroactive as of January 1, 1995]*

(Amended 2006)

| Table S.2.2. Categories of Device and Methods of Sealing | |
|--|--|
| Categories of Device | Methods of Sealing |
| Category 1: <i>No remote configuration capability.</i> | <i>Seal by physical seal or two event counters: one for calibration parameters and one for configuration parameters.</i> |
| Category 2: <i>Remote configuration capability, but access is controlled by physical hardware.</i> <i>The device shall clearly indicate that it is in the remote configuration mode and record such message if capable of printing in this mode or shall not operate while in this mode.</i> | <i>The hardware enabling access for remote communication must be on-site. The hardware must be sealed using a physical seal or an event counter for calibration parameters and an event counter for configuration parameters. The event counters may be located either at the individual measuring device or at the system controller; however, an adequate number of counters must be provided to monitor the calibration and configuration parameters of the individual devices at a location. If the counters are located in the system controller rather than at the individual device, means must be provided to generate a hard copy of the information through an on-site device.</i> |
| Category 3: <i>Remote configuration capability access may be unlimited or controlled through a software switch (e.g., password).</i> <i>The device shall clearly indicate that it is in the remote configuration mode and record such message if capable of printing in this mode or shall not operate while in this mode.</i> | <i>An event logger is required in the device; it must include an event counter (000 to 999), the parameter ID, the date and time of the change, and the new value of the parameter. A printed copy of the information must be available through the device or through another on-site device. The event logger shall have a capacity to retain records equal to 10 times the number of sealable parameters in the device, but not more than 1000 records are required. (Note: Does not require 1000 changes to be stored for each parameter.)</i> |

[Nonretroactive as of January 1, 1995]

(Table Added 2006)

S.2.3. Directional Flow Valves. – Valves intended to prevent reversal of flow shall be automatic in operation. However, on equipment used exclusively for fueling aircraft, such valves may be manual in operation.

S.2.4. Zero-Set-Back Interlock, Vehicle-Tank Meters, Electronic. – Except for vehicle-mounted metering systems used solely for the delivery of aviation fuel, a device shall be so constructed that after an individual or multiple deliveries at one location have been completed, an automatic interlock system shall engage to prevent a subsequent delivery until the indicating and, if equipped, recording elements have been returned to their zero position. For individual deliveries, if there is no product flow for three minutes the transaction must be completed before additional product flow is allowed. The 3-minute timeout shall be a sealable feature on an indicator.

[Nonretroactive as of January 1, 2006]

(Added 2005)

S.2.5. Automatic Temperature Compensation for Refined Petroleum Products.

S.2.5.1. Automatic Temperature Compensation for Refined Petroleum Products. – A device may be equipped with an automatic means for adjusting the indication and registration of the measured volume

of product to the volume at 15 °C for liters or the volume at 60 °F for gallons and decimal subdivisions or fractional equivalents thereof where not prohibited by state law.

S.2.5.2. Provision for Deactivating. – On a device equipped with an automatic temperature-compensating mechanism that will indicate or record only in terms of liters compensated to 15°C or gallons compensated to 60 °F, provision shall be made for deactivating the automatic temperature-compensating mechanism so the meter can indicate and record, if it is equipped to record, in terms of the uncompensated volume.

S.2.5.3. Gross and Net Indications. – A device equipped with automatic temperature compensation shall indicate or record, if equipped to record, both the gross (uncompensated) and net (compensated) volume for testing purposes. It is not necessary that both net and gross volume be displayed simultaneously.

S.2.5.4. Provision for Sealing Automatic Temperature-Compensating Systems. – Adequate provision shall be made for an approved means of security (e.g., data change audit trail) or physically applying security seals in such a manner that an automatic temperature-compensating system cannot be disconnected and no adjustment may be made to the system.

S.2.5.5. Temperature Determination with Automatic Temperature Compensation. – For test purposes, means shall be provided (e.g., thermometer well) to determine the temperature of the liquid either:

- (a) in the liquid chamber of the meter; or
- (b) immediately adjacent to the meter in the meter inlet or discharge line.

(Added 2007)

S.2.6. Thermometer Well, Temperature Determination. *For test purposes, means shall be provided (e.g., thermometer well) to determine the temperature ~~of~~ the liquid either in the:*

- (a) liquid chamber of the meter; or
- (b) meter inlet or discharge line immediately adjacent to the meter.

[Nonretroactive as of January 1, 2012)

(Added 2011)

S.3. Design of Discharge Lines and Discharge Line Valves.

(Not applicable to milk-metering systems.)

S.3.1. Diversion of Measured Liquid. – Except on equipment used exclusively for fueling aircraft, no means shall be provided by which any measured liquid can be diverted from the measuring chamber of the meter or the discharge line thereof. However, two or more delivery outlets may be installed if means is provided to insure that:

- (a) liquid can flow from only one such outlet at one time; and
- (b) the direction of flow for which the mechanism may be set at any time is definitely and conspicuously indicated.

S.3.2. Pump-Discharge Unit. – On a pump-discharge unit, the discharge hose shall be of the wet-hose type with a shutoff valve at its outlet end. However, a pump-discharge unit may be equipped also with a dry-hose without a shutoff valve at its outlet end, but only if:

- (a) the dry-hose is as short as practicable; and

- (b) there is incorporated in the discharge piping, immediately adjacent to the meter, effective means to insure that liquid can flow through only one of the discharge hoses at any one time and that the meter and the wet-hose remain full of liquid at all times.

S.3.3. Gravity-Discharge Unit. – On a gravity-discharge unit, the discharge hose or equivalent pipe shall be of the dry-hose type with no shutoff valve at its outlet end. The dry-hose shall be of such stiffness and only of such length as to facilitate its drainage. The inlet end of the hose or of an equivalent outlet pipe shall be of such height as to provide for proper drainage of the hose or pipe. There shall be incorporated an automatic vacuum breaker or equivalent means to prevent siphoning and to ensure the rapid and complete drainage.

S.3.4. Discharge Hose. – A discharge hose shall be adequately reinforced.

S.3.5. Discharge Valve. – A discharge valve may be installed in the discharge line only if the device is of the wet-hose type, in which case such valve shall be at the discharge end of the line. Any other shutoff valve on the discharge side of the meter shall be of the automatic or semiautomatic predetermined-stop type or shall be operable only:

- (a) by means of a tool (but not a pin) entirely separate from the device; or
- (b) by mutilation of a security seal with which the valve is sealed open.

S.3.6. Antidrain Valve. – In a wet-hose, pressure-type device, an effective antidrain valve shall be incorporated in the discharge valve or immediately adjacent thereto. The antidrain valve shall function so as to prevent the drainage of the discharge hose. However, a device used exclusively for fueling and defueling aircraft may be of the pressure type without an antidrain valve.

S.4. Design of Intake Lines (for Milk-Metering Systems).

S.4.1. Diversion of Liquid to be Measured. – No means shall be provided by which any liquid can be diverted from the supply tank to the receiving tank without being measured by the device.

S.4.2. Intake Hose. – The intake hose shall be:

- (a) of the dry-hose type;
- (b) adequately reinforced;
- (c) not more than 6 m (20 ft) in length, unless it can be demonstrated that a longer hose is essential to permit pickups from a supply tank; and
- (d) connected to the pump at horizontal or above, to permit complete drainage of the hose.

S.5. Marking Requirements.

S.5.1. Limitation of Use. – If a meter is intended to measure accurately only liquids having particular properties, or to measure accurately only under specific installation or operating conditions, or to measure accurately only when used in conjunction with specific accessory equipment, these limitations shall be clearly and permanently stated on the meter.

S.5.2. Discharge Rates. – A meter shall be marked to show its designed maximum and minimum discharge rates. However, the minimum discharge rate shall not exceed 20 % of the maximum discharge rate.

Note: See example in Section 3.30. Liquid-Measuring Devices Code, paragraph S.4.4.1. Discharge Rates.
(Added 2003)

S.5.3. Measuring Components, Milk-Metering System. – All components that affect the measurement of milk that are disassembled for cleaning purposes shall be clearly and permanently identified with a common serial number.

S.5.4. Flood Volume, Milk-Metering System. – When applicable, the volume of product necessary to flood the system when dry shall be clearly, conspicuously, and permanently marked on the air eliminator.

S.5.5. Conversion Factor. – When the conversion factor of 1.03 kg/L (8.6 lb/gal) is used to convert the volume of milk to weight, the conversion factor shall be clearly marked on the primary indicating element and recorded on the delivery ticket.

(Added 1989)

S.5.6. Temperature Compensation for Refined Petroleum Products. – If a device is equipped with an automatic temperature compensator, the primary indicating elements, recording elements, and recorded representations shall be clearly and conspicuously marked to show the volume delivered has been adjusted to the volume at 15 °C for liters or the volume at 60 °F for gallons and decimal subdivisions or fractional equivalents thereof.

(Added 2007)

S.5.7. Meter Size. – *Except for milk meters, if the meter model identifier does not provide a link to the meter size (in terms of pipe diameter) on an NTEP Certificate of Conformance, the meter shall be marked to show meter size.*

[Non-retroactive as of January 1, 2009]

(Added 2008)

N. Notes

N.1. Test Liquid.

(a) A measuring system shall be tested with the liquid to be commercially measured or with a liquid of the same general physical characteristics. Following a satisfactory examination, the weights and measures official should attach a seal or tag indicating the product used during the test.

(Amended 1975)

(b) A milk-measuring system shall be tested with the type of milk to be measured when the accuracy of the system is affected by the characteristics of milk (e.g., positive displacement meters).

(Added 1989)

(Amended 1975 and 1989)

N.2. Evaporation and Volume Change. – Care shall be exercised to reduce to a minimum, evaporation losses and volume changes resulting from changes in temperature of the test liquid.

N.3. Test Drafts. – Test drafts should be equal to at least the amount delivered by the device in 1 minute at its maximum discharge rate, and shall in no case be less than 180 L (50 gal) or 225 kg (500 lb).

(Amended 1989)

N.4. Testing Procedures.

N.4.1. Normal Tests. – The “normal” test of a measuring system shall be made at the maximum discharge rate that may be anticipated under the conditions of the installation. Any additional tests conducted at flow rates down to and including one-half of the sum of the maximum discharge flow rate and the rated minimum discharge flow rate shall be considered normal tests.

(Amended 1992)

N.4.1.1. Milk Measuring System. – The “normal” test shall include a determination of the effectiveness of the air elimination system.

N.4.1.2. Repeatability Tests. – Tests for repeatability should include a minimum of three consecutive test drafts of approximately the same size and be conducted under controlled conditions where variations in factors such as temperature, pressure, and flow rate are reduced to the extent that they will not affect the results obtained.

(Added 2001)

N.4.1.3. Automatic Temperature-Compensating Systems for Refined Petroleum Products. – On devices equipped with automatic temperature-compensating systems, normal tests shall be conducted:

- (a) by comparing the compensated volume indicated or recorded to the actual delivered volume corrected to 15 °C for liters or 60 °F for gallons and decimal subdivisions or fractional equivalents thereof; and
- (b) with the temperature-compensating system deactivated, comparing the uncompensated volume indicated or recorded to the actual delivered volume.

The first test shall be performed with the automatic temperature-compensating system operating in the “as-found” condition. On devices that indicate or record both the compensated and uncompensated volume for each delivery, the tests in (a) and (b) may be performed as a single test.

(Added 2007)

N.4.2. Special Tests (Except Milk-Measuring Systems). – “Special” tests shall be made to develop the operating characteristics of a measuring system and any special elements and accessories attached to or associated with the device. Any test except as set forth in N.4.1. Normal Tests and N.4.5. Product Depletion Test shall be considered a special test. Special tests of a measuring system shall be made at a minimum discharge rate of 20 % of the marked maximum discharge rate or at the minimum discharge rate marked on the device, whichever is less.

(Amended 1978 and 2005)

N.4.3. Antidrain Valve Test. – The effectiveness of the antidrain valve shall be tested after the pump pressure in the measuring system has been released and a valve between the supply tank and the discharge valve is closed.

N.4.4. System Capacity. – The test of a milk-measuring system shall include the verification of the volume of product necessary to flood the system as marked on the air eliminator.

N.4.5. Product Depletion Test. – Except for vehicle-mounted metering systems used solely for the delivery of aviation fuel, the effectiveness of the vapor eliminator or vapor elimination means shall be tested by dispensing product at the normal flow rate until the product supply is depleted and continuing until the lack of fluid causes the meter indication to stop completely for at least 10 seconds. If the meter indication fails to stop completely for at least 10 seconds, continue to operate the system for 3 minutes. Finish the test by switching to another compartment with sufficient product to complete the test on a multi-compartment vehicle or by adding sufficient product to complete the test to a single compartment vehicle. When adding product to a single compartment vehicle, allow appropriate time for any entrapped vapor to disperse before continuing the test. Test drafts shall be of the same size and run at approximately the same flow rate.

(Added 2005)

N.5. Temperature Correction for Refined Petroleum Products. – Corrections shall be made for any changes in volume resulting from the differences in liquid temperatures between the time of passage through the meter and the time of volumetric determination in the prover. When adjustments are necessary, appropriate petroleum measurement tables should be used.

(Added 2007)

T. Tolerances

T.1. Application.

T.1.1. To Underregistration and to Overregistration. – The tolerances hereinafter prescribed shall be applied to errors of underregistration and errors of overregistration.

T.2. Tolerance Values. – Tolerances shall be as shown in Table 1. Accuracy Classes and Tolerances for Vehicle-Tank Meters and Table 2. Tolerances for Vehicle-Mounted Milk Meters.
(Amended 1995)

| Table 1. Accuracy Classes and Tolerances for Vehicle-Tank Meters | | | | |
|---|---|----------------------|-----------------------|------------------------|
| Accuracy Class | Application | Acceptance Tolerance | Maintenance Tolerance | Special Test Tolerance |
| 0.3 | <ul style="list-style-type: none"> - Petroleum products delivered from large capacity (flow rates over 115 L/min or 30 gpm)** devices, including motor-fuel devices - Heated products (other than asphalt) at temperatures greater than 50 °C (122 °F) - Asphalt at temperatures equal to or below a temperature of 50 °C (122 °F) - All other liquids not shown in the table where the typical delivery is greater than 200 L (50 gal) | 0.15 % | 0.3 % | 0.45 % |
| 0.3A | <ul style="list-style-type: none"> - Asphalt at temperatures greater than 50 °C (122 °F) | 0.3 % | 0.3 % | 0.5 % |
| 0.5* | <ul style="list-style-type: none"> - Petroleum products delivered from small capacity (at 4 L/min (1 gpm) through 115 L/min or 30 gpm)** motor-fuel devices - Agri-chemical liquids - All other applications not shown in the table where the typical delivery is ≤ 200 L (50 gal) | 0.3 % | 0.5 % | 0.5 % |
| 1.1 | <ul style="list-style-type: none"> - Petroleum products and other normal liquids from devices with flow rates** less than 4 L/min (1 gpm) and - Devices designed to deliver less than 4 L (1 gal) | 0.75 % | 1.0 % | 1.25 % |
| 1.5 | <ul style="list-style-type: none"> - Water | Overregistration | 1.5 % | 1.5 % |
| | | Underregistration | 1.5 % | 5.0 % |
| <p>* For 5 gal and 10 gal test drafts, the tolerances specified for Accuracy Class 0.5 in the table above do not apply. For these test drafts, the maintenance tolerances on normal and special tests for 5 gal and 10 gal test drafts are 6 in³ and 11 in³, respectively. Acceptance tolerances on normal and special tests are 3 in³ and 5.5 in³.</p> <p>** Flow rate refers to designed or marked maximum flow rate.</p> | | | | |

(Added 2002) (Amended 2013)

| Table 2. Tolerances for Vehicle-Mounted Milk Meters | | |
|--|---|---|
| Indication (gallons) | Maintenance Tolerance (gallons) | Acceptance Tolerance (gallons) |
| 100 | 0.5 | 0.3 |
| 200 | 0.7 | 0.4 |
| 300 | 0.9 | 0.5 |
| 400 | 1.1 | 0.6 |
| 500 | 1.3 | 0.7 |
| Over 500 | Add 0.002 gallon per indicated gallon over 500 | Add 0.001 gallon per indicated gallon over 500 |

(Added 1989)

T.2.1. Automatic Temperature-Compensating Systems. – The difference between the meter error (expressed as a percentage) for results determined with and without the automatic temperature-compensating system activated shall not exceed:

- (a) 0.2 % for mechanical automatic temperature-compensating systems; and
- (b) 0.1 % for electronic automatic temperature-compensating systems.

The delivered quantities for each test shall be approximately the same size. The results of each test shall be within the applicable acceptance or maintenance tolerance.

(Added 2007) (Amended 2010)

T.3. Repeatability. – When multiple tests are conducted at approximately the same flow rate and draft size, the range of the test results for the flow rate shall not exceed 40 % of the absolute value of the maintenance tolerance and the results of each test shall be within the applicable tolerance. (~~See also~~ **Also see** N.4.1.2. Repeatability Tests.)

(Added 1992) (Amended 2001 and 2002)

T.4. Product Depletion Test. – The difference between the test result for any normal test and the product depletion test shall not exceed ~~the tolerance shown in Table T.4.~~ **0.5 % of the volume delivered in one minute at the maximum flow rate marked on the meter for meters rated higher than 380 Lpm (100 gpm) or 0.6 % of the volume delivered in one minute at the maximum flow rate marked on the meter for meters rated 380 Lpm (100 gpm) or lower.** Test drafts shall be of the same size and run at approximately the same flow rate.

Note: The result of the product depletion test may fall outside of the applicable test tolerance as specified in Table 1. Accuracy Classes and Tolerances for Vehicle-Tank Meters.

| Table T.4. Tolerances for Vehicle Tank Meters on Product Depletion Tests, Except Milk Meters | |
|---|--|
| Meter Size | Maintenance and Acceptance Tolerances |
| Up to, but not including, 50 mm (2 in) | 1.70 L (104 in ³) [†] |
| From 50 mm (2 in) up to, but not including, 75 mm (3 in) | 2.25 L (137 in ³) [†] |
| 75 mm (3 in) or larger | 3.75 L (229 in ³) [†] |

[†]Based on a test volume of at least the amount specified in N.3. Test Drafts.

(Table Added 2005)(Amended 2013)

UR. User Requirements

UR.1. Installation Requirements.

UR.1.1. Discharge Rate. – A meter shall be so installed that the actual maximum discharge rate will not exceed the rated maximum discharge rate. If necessary, means for flow regulation shall be incorporated in the installation, in which case this shall be fully effective and automatic in operation.

UR.1.2. Unit Price. – There shall be displayed on the face of a device of the computing type the unit price at which the device is set to compute.

UR.1.3. Intake Hose. – The intake hose in a milk-metering system shall be installed to permit complete drainage and ensure that all available product is measured following each pickup.

UR.1.4. Liquid Measured. – A vehicle-tank meter shall continue to be used to measure the same liquid or one with the same general physical properties as that used for calibration and weights and measures approval unless the meter is recalibrated with a different product and tested by a registered service agency or a weights and measures official and approved by the weights and measures jurisdiction having statutory authority over the device.

(Added 2003)

UR.2. Use Requirements.

UR.2.1. Return of Indicating and Recording Elements to Zero. – The primary indicating elements (visual), and the primary recording elements, when these are returnable to zero, shall be returned to zero immediately before each delivery is begun and after the pump has been activated and the product to be measured has been supplied to the measuring system.

(Amended 1981)

UR.2.2. Ticket Printer, Customer Ticket. – Vehicle-Mounted metering systems shall be equipped with a ticket printer which shall be used for all sales where product is delivered through the meter. A copy of the ticket issued by the device shall be left with the customer at the time of delivery or as otherwise specified by the customer.

(Added 1993) (Amended 1994)

UR.2.2.1. Exceptions for the Sale of Aviation Fuel. – The provisions of UR.2.2. Ticket Printer, Customer Ticket shall not apply to vehicle-mounted metering systems used solely for the delivery of aviation fuel into aircraft and for aircraft-related operations.

(Added 1999)

UR.2.3. Ticket in Printing Device. – A ticket shall not be inserted into a device equipped with a ticket printer until immediately before a delivery is begun, and in no case shall a ticket be in the device when the vehicle is in motion while on a public street, highway, or thoroughfare.

UR.2.4. Credit for Flood Volume. – The volume of product necessary to flood the system as marked on the air eliminator shall be individually recorded on the pickup ticket of each seller affected.

UR.2.5. Automatic Temperature Compensation for Refined Petroleum Products.

UR.2.5.1. When to be Used. – In a state that does not prohibit, by law or regulation, the sale of temperature-compensated product, a device equipped with an activated automatic-temperature compensator shall be connected, operable, and in use at all times. An electronic or mechanical automatic temperature-compensating device or system may not be removed or deactivated, nor may a compensated device be replaced with an uncompensated device or system, without the written approval of the responsible weights and measures jurisdiction.

Note: This requirement does not specify the method of sale for products measured through a meter.

(Amended 2009)

UR.2.5.2. Period of Use. – When fuel is bought or sold on an automatic temperature compensation basis, it shall be bought or sold using this basis over at least a consecutive 12-month period unless otherwise agreed to by both the buyer and seller in writing.

(Added 2009)

UR.2.5.3. Invoices. – An invoice based on a reading of a device that is equipped with an automatic temperature compensator shall show that the volume delivered has been adjusted to the volume at 15 °C for liters or the volume at 60 °F for gallons and decimal subdivisions or fractional equivalents thereof.

(Added 2007)

THIS PAGE INTENTIONALLY LEFT BLANK

MARKUP COPY

Section 3.32. Liquefied Petroleum Gas and Anhydrous Ammonia Liquid-Measuring Devices³⁹

A. Application.

A.1. General. – This code applies to devices used for the measurement of liquefied petroleum gas and anhydrous ammonia in the liquid state, whether such devices are installed in a permanent location or mounted on a vehicle.

A.2. Devices Used to Measure Other Liquid Products not Covered in Specific Codes. – Insofar as they are clearly appropriate, the requirements and provisions of the code may be applied to devices used for the measurement of other liquids that do not remain in a liquid state at atmospheric pressures and temperatures.

A.3. Exceptions. – This code does not apply to mass flow meters (~~←(Also see Section 3.37. Code for Mass Flow Meters)→~~)

(Added 1994)

A.4. Additional Code Requirements. – In addition to the requirements of this code, LPG and Anhydrous Ammonia Liquid-Measuring Devices shall meet the requirements of Section 1.10. General Code.

S. Specifications

S.1. Design of Indicating and Recording Elements and of Recorded Representations.

S.1.1. Primary Elements.

S.1.1.1. General. – A device shall be equipped with a primary indicating element and may also be equipped with a primary recording element.

Note: Vehicle-mounted metering systems shall be equipped with a primary recording element as required by paragraph UR.2.6. Ticket Printer; Customer Ticket.

S.1.1.2. Units. – A device shall indicate, and record if the device is equipped to record, its deliveries in terms of liters, gallons, quarts, pints, or binary-submultiple or decimal subdivisions of the liter or gallon.

(Amended 1987)

S.1.1.3. Value of Smallest Unit. – The value of the smallest unit of indicated delivery, and recorded delivery if the device is equipped to record, shall not exceed the equivalent of:

- (a) 0.5 L (1 pt) on retail devices; or
- (b) 5 L (1 gal) on wholesale devices.

(Amended 1987)

S.1.1.4. Advancement of Indicating and Recording Elements. – Primary indicating and recording elements shall be susceptible to advancement only by the mechanical operation of the device. However, a device may be cleared by advancing its elements to zero, but only if:

- (a) the advancing movement, once started, cannot be stopped until zero is reached; or

³⁹Title amended 1986.

- (b) in the case of indicating elements only, such elements are automatically obscured until the elements reach the correct zero position.

S.1.1.5. Money-Values, Mathematical Agreement. – Any digital money-value indication and any recorded money-value on a computing-type device shall be in mathematical agreement with its associated quantity indication or representation to within 1 cent of money-value; except that a stationary retail computing-type device must compute and indicate to the nearest 1 cent of money-value. (See Also see Section 1.10. General Code G-S.5.5. Money-Values, Mathematical Agreement.)
(Amended 1984 and 1988)

S.1.1.6. Printed Ticket. – Any printed ticket issued by a device of the computing type on which there is printed the total computed price, shall have printed clearly thereon the total volume of the delivery in terms of liters or gallons, and the appropriate decimal fraction of the liter or gallon, and the corresponding price per liter or gallon.
(Added 1979) (Amended 1987)

S.1.2. Graduations.

S.1.2.1. Length. – Graduations shall be so varied in length that they may be conveniently read.

S.1.2.2. Width. – In any series of graduations, the width of a graduation shall in no case be greater than the width of the minimum clear interval between graduations, and the width of main graduations shall be not more than 50 % greater than the width of subordinate graduations. Graduations shall in no case be less than 0.2 mm (0.008 in) in width.

S.1.2.3. Clear Interval between Graduations. – The clear interval shall be not less than 1.0 mm (0.04 in). If the graduations are not parallel, the measurement shall be made:

- (a) along the line of relative movement between the graduations at the end of the indicator; or
- (b) if the indicator is continuous, at the point of widest separation of the graduations.

S.1.3. Indicators.

S.1.3.1. Symmetry. – The index of an indicator shall be symmetrical with respect to the graduations, at least throughout that portion of its length associated with the graduations.

S.1.3.2. Length. – The index of an indicator shall reach to the finest graduations with which it is used, unless the indicator and the graduations are in the same plane, in which case the distance between the end of the indicator and the ends of the graduations, measured along the line of graduations, shall be not more than 1.0 mm (0.04 in).

S.1.3.3. Width. – The width of the index of an indicator in relation to the series of graduations with which it is used shall be not greater than:

- (a) *the width of the narrowest graduation;** and
[*Nonretroactive as of January 1, 2002]
(Amended 2001)
- (b) the width of the minimum clear interval between graduations.

When the index of an indicator extends along the entire length of a graduation, that portion of the index of the indicator that may be brought into coincidence with the graduation shall be of the same width throughout the length of the index that coincides with the graduation.

S.1.3.4. Clearance. – The clearance between the index of an indicator and the graduations shall in no case be more than 1.5 mm (0.06 in).

S.1.3.5. Parallax. – Parallax effects shall be reduced to the practicable minimum.

S.1.4. For Retail Devices Only.

S.1.4.1. Indication of Delivery. – A retail device shall be constructed to show automatically its initial zero condition and the amounts delivered up to the nominal capacity of the device.

S.1.4.2. Return to Zero.

- (a) Primary indicating elements shall be readily returnable to a definite zero indication.
- (b) Primary recording elements on a stationary retail device shall be readily returnable to a definite zero indication if the device is equipped to record.
- (c) Means shall be provided to prevent the return of primary indicating elements and of primary recording elements if these are returnable to zero, beyond their correct zero position.

(Amended 1990)

S.1.5. For Stationary Retail Devices Only.

S.1.5.1. Display of Unit Price and Product Identity. – In a device of the computing type, means shall be provided for displaying on each face of the device the unit price at which the device is set to compute or to deliver as the case may be, and there shall be conspicuously displayed on each side of the device the identity of the product that is being dispensed. If a device is so designed as to dispense more than one grade, brand, blend, or mixture of product, the identity of the grade, brand, blend, or mixture being dispensed shall also be displayed on each face of the device.

S.1.5.2. Money-Value Computations. – A computing device shall compute the total sales price at any single-purchase unit price (excluding fleet sales and other price contract sales) for which the product is offered for sale at any delivery possible within either the measurement range of the device or the range of the computing elements, whichever is less. The analog money-value indication shall not differ from the mathematically computed money-value (quantity x unit price = sales price), for any delivered quantity, by an amount greater than the values shown in Table 1. Money-Value Divisions and Maximum Allowable Variations for Money-Value Computations on Mechanical Analog Computers.

(Amended 1995)

| Table 1. Money-Value Divisions and Maximum Allowable Variations for Money-Value Computations on Mechanical Analog Computers | | | | |
|--|-----------------------------------|--------------------------------------|--|-----------------------|
| Unit Price | | Money- Value Division | Maximum Allowable Variation | |
| From | To and Including | | Design Test | Field Test |
| 0 | \$0.25/liter or \$1.00/gallon | 1¢ | ± 1¢ | ± 1¢ |
| \$0.25/liter or \$1.00/gallon | \$0.75/liter or \$3.00/gallon | 1¢ or 2¢ | ± 1¢ | ± 2¢ |
| \$0.75/liter or \$3.00/gallon | \$2.50/liter or \$10.00/gallon | 1¢ or 2¢ | ± 1¢ | ± 2¢ |
| \$0.75/liter or \$3.00/gallon | \$2.50/liter or \$10.00/gallon | 5¢ | ± 2½¢ | ± 5¢ |

S.1.5.2.1. Money-Value Divisions, Analog. – The value of the graduated intervals representing money-values on a computing-type device with analog indications shall be as follows:

- (a) Not more than 1 cent at all unit prices up to and including \$0.25 per liter or \$1.00 per gallon.
 - (b) Not more than 2 cents at unit prices greater than \$0.25 per liter or \$1.00 per gallon up to and including \$0.75 per liter or \$3.00 per gallon.
 - (c) Not more than 5 cents at all unit prices greater than \$0.75 per liter or \$3.00 per gallon.
- (Amended 1984)

S.1.5.2.2. Money-Value Divisions, Digital. – A computing-type device with digital indications shall comply with the requirements of paragraph G.-S.5.5. Money-Values, Mathematical Agreement, and the total price computation shall be based on quantities not exceeding 0.01 gal intervals for devices indicating in inch-pound units and 0.05 L for devices indicating in metric units.

S.1.5.2.3. Money-Value Divisions, Auxiliary Indications. – *In a system equipped with auxiliary indications, all indicated money-value divisions shall be identical.*
[Nonretroactive as of January 1, 1985.]

S.1.6. For Wholesale Devices Only.

S.1.6.1. Travel of Indicator. – A wholesale device shall be readily operable to deliver accurately any quantity from 180 L (50 gal) to the capacity of the device. If the most sensitive element of the indicating system uses an indicator and graduations, the relative movement of these parts corresponding to a delivery of 5 L (1 gal) shall be not less than 5 mm (0.20 in).

(Amended 1987)

S.2. Design of Measuring Elements.

S.2.1. Vapor Elimination. – A device shall be equipped with an effective vapor eliminator or other effective means to prevent the passage of vapor through the meter.

S.2.2. Provision for Sealing. – Adequate provision shall be made for an approved means of security (e.g., data change audit trail) or for physically applying a security seal in such a manner that requires the security seal to be broken before an adjustment or interchange may be made of:

- (a) any measuring or indicating element;
- (b) any adjustable element for controlling delivery rate, when such rate tends to affect the accuracy of deliveries; and
- (c) any metrological parameter that will affect the metrological integrity of the device or system.

When applicable, the adjusting mechanism shall be readily accessible for purposes of affixing a security seal.

*[Audit trails shall use the format set forth in Table S.2.2. Categories of Device and Methods of Sealing.]**
*[*Nonretroactive as of January 1, 1995]*

(Amended 2006)

| Table S.2.2. Categories of Device and Methods of Sealing | |
|--|--|
| Categories of Device | Methods of Sealing |
| Category 1: <i>No remote configuration capability.</i> | <i>Seal by physical seal or two event counters: one for calibration parameters and one for configuration parameters.</i> |
| Category 2: <i>Remote configuration capability, but access is controlled by physical hardware.</i> <i>The device shall clearly indicate that it is in the remote configuration mode and record such message if capable of printing in this mode or shall not operate while in this mode.</i> | <i>The hardware enabling access for remote communication must be on-site. The hardware must be sealed using a physical seal or an event counter for calibration parameters and an event counter for configuration parameters. The event counters may be located either at the individual measuring device or at the system controller; however, an adequate number of counters must be provided to monitor the calibration and configuration parameters of the individual devices at a location. If the counters are located in the system controller rather than at the individual device, means must be provided to generate a hard copy of the information through an on-site device.</i> |
| Category 3: <i>Remote configuration capability access may be unlimited or controlled through a software switch (e.g., password).</i> <i>The device shall clearly indicate that it is in the remote configuration mode and record such message if capable of printing in this mode or shall not operate while in this mode.</i> | <i>An event logger is required in the device; it must include an event counter (000 to 999), the parameter ID, the date and time of the change, and the new value of the parameter. A printed copy of the information must be available through the device or through another on-site device. The event logger shall have a capacity to retain records equal to 10 times the number of sealable parameters in the device, but not more than 1000 records are required. (Note: Does not require 1000 changes to be stored for each parameter.)</i> |

[Nonretroactive as of January 1, 1995]

(Table Added 2006)

S.2.3. Directional Flow Valves. – A measuring system shall be equipped with a valve or other effective means, automatic in operation and installed in or adjacent to the measuring element, to prevent reversal of flow of the product being measured.

(Amended 1982)

S.2.4. Maintenance of Liquid State. – A device shall be so designed and installed that the product being measured will remain in a liquid state during the passage through the meter.

S.2.5. Thermometer Well. – For test purposes, means shall be provided to determine the temperature of the liquid either:

- (a) in the liquid chamber of the meter; or
- (b) in the meter inlet or discharge line and immediately adjacent to the meter.

(Amended 1987)

S.2.6. Automatic Temperature Compensation. – A device may be equipped with an adjustable automatic means for adjusting the indication and registration of the measured volume of product to the volume at 15 °C (60 °F).

S.2.6.1. Provision for Deactivating. – On a device equipped with an automatic temperature-compensating mechanism that will indicate or record only in terms of liters or gallons adjusted to 15 °C (60 °F), provision shall be made to facilitate the deactivation of the automatic temperature-compensating mechanism so that the meter may indicate, and record if it is equipped to record, in terms of the uncompensated volume.

(Amended 1972)

S.2.6.2. Provision for Sealing. – Provision shall be made for applying security seals in such a manner that an automatic temperature-compensating system cannot be disconnected and that no adjustment may be made to the system.

S.3. Design of Discharge Lines and Discharge Line Valves.

S.3.1. Diversion of Measured Liquid. – No means shall be provided by which any measured liquid can be diverted from the measuring chamber of the meter or the discharge line therefrom. However, two or more delivery outlets may be permanently installed if means are provided to insure that:

- (a) liquid can flow from only one such outlet at one time; and
- (b) the direction of flow for which the mechanism may be set at any time is definitely and conspicuously indicated.

In addition, a manually controlled outlet that may be opened for the purpose of emptying a portion of the system to allow for repair and maintenance operations shall be permitted. Effective means shall be provided to prevent the passage of liquid through any such outlet during normal operation of the device and to indicate clearly and unmistakably when the valve controls are so set as to permit passage of liquid through such outlet.

(Amended 1975)

S.3.2. Delivery Hose. – The delivery hose of a retail device shall be of the wet-hose type with a shutoff valve at its outlet end.

S.4. Marking Requirements.

S.4.1. Limitation of Use. – If a device is intended to measure accurately only products having particular properties, or to measure accurately only under specific installation or operating conditions, or to measure accurately only when used in conjunction with specific accessory equipment, these limitations shall be clearly and permanently stated on the device.

S.4.2. Discharge Rates. – A device shall be marked to show its designed maximum and minimum discharge rates. The marked minimum discharge rate shall not exceed:

(a) 20 L (5 gal) per minute for stationary retail devices; or

(b) 20 % of the marked maximum discharge rate for other retail devices and for wholesale devices.

(Amended 1987)

Note: ~~See~~Also see example in Section 3.30. Liquid-Measuring Devices Code, paragraph S.4.4.1. Discharge Rates. (Added 2003)

S.4.3. Location of Marking Information; Retail Motor-Fuel Dispensers. – *The marking information required in General Code, paragraph G-S.1. Identification shall appear as follows:*

(d) *within 60 cm (24 in) to 150 cm (60 in) from the base of the dispenser;*

(e) *either internally and/or externally provided the information is permanent and easily read; and*

(f) *on a portion of the device that cannot be readily removed or interchanged (i.e., not on a service access panel).*

Note: The use of a dispenser key or tool to access internal marking information is permitted for retail motor-fuel dispensers. [Nonretroactive as of January 1, 2003]

(Added 2006)

S.4.4. Temperature Compensation. – If a device is equipped with an automatic temperature compensator, the primary indicating elements, recording elements, and recorded representation shall be clearly and conspicuously marked to show that the volume delivered has been adjusted to the volume at 15 °C (60 °F).

N. Notes

N.1. Test Liquid. – A device shall be tested with the liquid to be commercially measured or with a liquid of the same general physical characteristics.

N.2. Vaporization and Volume Change. – Care shall be exercised to reduce to a minimum, vaporization and volume changes.

N.3. Test Drafts. – Test drafts should be equal to at least the amount delivered by the device in one minute at its normal discharge rate.

(Amended 1982)

N.4. Testing Procedures.

N.4.1. Normal Tests. – The “normal” test of a device shall be made at the maximum discharge flow rate developed under the conditions of the installation. Any additional tests conducted at flow rates down to and including one-half the sum of the maximum discharge flow rate and the rated minimum discharge flow rate shall be considered normal tests.

(Amended 1998)

N.4.1.1. Automatic Temperature Compensation. – On devices equipped with automatic temperature-compensating systems, normal tests shall be conducted as follows:

- (a) by comparing the compensated volume indicated or recorded to the actual delivered volume adjusted to 15 °C (60 °F); and
- (b) with the temperature-compensating system deactivated, comparing the uncompensated volume indicated or recorded to the actual delivered volume.

The first test shall be performed with the automatic temperature-compensating system operating in the “as found” condition. On devices that indicate or record both the compensated and uncompensated volume for each delivery, the tests in (a) and (b) may be performed as a single test.

(Amended 1987)

N.4.1.2. Repeatability Tests. – Tests for repeatability should include a minimum of three consecutive test drafts of approximately the same size and be conducted under controlled conditions where variations in factors such as temperature, pressure, and flow rate are reduced to the extent that they will not affect the results obtained.

(Added 2001)

N.4.2. Special Tests. – “Special” tests shall be made to develop the operating characteristics of a device and any special elements and accessories attached to or associated with the device. Any test except as set forth in N.4.1. Normal Tests shall be considered a special test.

N.4.2.1. For Motor-Fuel Devices. – A motor-fuel device shall be so tested at a minimum discharge rate of:

- (a) 20 L (5 gal) per minute; or
- (b) the minimum discharge rate marked on the device, whichever is less.

N.4.2.2. For Other Retail Devices. – A retail device other than a motor-fuel device shall be tested at a minimum discharge rate of the:

- (a) minimum discharge rate that can be developed under the conditions of installation; or
- (b) minimum discharge rate marked on the device, whichever is greater.

(Amended 1973)

N.4.2.3. For Wholesale Devices. – A wholesale device shall be so tested at a minimum discharge rate of:

- (a) 40 L (10 gal) per minute for a device with a rated maximum discharge less than 180 L (50 gal) per minute.
- (b) 20 % of the marked maximum discharge rate for a device with a rated maximum discharge of 180 L (50 gal) per minute or more, or
- (c) the minimum discharge rate marked on the device, whichever is least.

(Amended 1987)

N.4.3. Money-Value Computation Tests.

N.4.3.1. Laboratory Design Evaluation Tests. – In the conduct of laboratory design evaluation tests, compliance with paragraph S.1.5.2. Money-Value Computations shall be determined by using the cone gear as a reference for the total quantity delivered. The indicated delivered quantity shall agree with the cone gear representation with the index of the indicator within the width of the graduation. The maximum allowable variation of the indicated sales price shall be as shown in Table 1. Money-Value Divisions and Maximum Allowable Variations for Money-Value Computations on Mechanical Analog Computers.

N.4.3.2. Field Tests. – In the conduct of field tests to determine compliance with paragraph S.1.5.2. Money-Value Computations the maximum allowable variation in the indicated sales price shall be as shown in Table 1. Money-Value Divisions and Maximum Allowable Variations for Money-Value Computations on Mechanical Analog Computers.

(Added 1984)

N.5. Temperature Correction. – Adjustments shall be made for any changes in volume resulting from the differences in liquid temperatures between time of passage through the meter and time of volumetric determination in the prover. When adjustments are necessary, appropriate petroleum measurement tables should be used.

T. Tolerances

T.1. Application.

T.1.1. To Underregistration and to Overregistration. – The tolerances hereinafter prescribed shall be applied to errors of underregistration and errors of overregistration, whether or not a device is equipped with an automatic temperature compensator.

T.2. Tolerance Values. – The maintenance and acceptance tolerances for normal and special tests shall be as shown in Table T.2. Accuracy Classes and Tolerances for LPG and Anhydrous Ammonia Liquid-Measuring Devices.

(Amended 2003)

| Accuracy Class | Application | Acceptance Tolerance | Maintenance Tolerance | Special Test Tolerance |
|-----------------------|--|-----------------------------|------------------------------|-------------------------------|
| 1.0 | Anhydrous ammonia, LPG (including vehicle-mounted meters) | 0.6 % | 1.0 % | 1.0 % |

(Added 2003)

T.3. Repeatability. – When multiple tests are conducted at approximately the same flow rate and draft size, the range of the test results for the flow rate shall not exceed 40 % of the absolute value of the maintenance tolerance and the results of each test shall be within applicable tolerance. This tolerance does not apply to the test of the automatic temperature-compensating system. See (Also see also N.4.1.2. Repeatability Tests-)

(Added 1992) (Amended 1997 and 2001)

T.4. Automatic Temperature-Compensating Systems. – The difference between the meter error (expressed as a percentage) for results determined with and without the automatic temperature-compensating system activated shall not exceed:

- (a) 1.0 % for mechanical automatic temperature-compensating systems; and
- (b) 0.5 % for electronic automatic temperature-compensating systems.

The delivered quantities for each test shall be approximately the same size. The results of each test shall be within the applicable acceptance or maintenance tolerance.

(Added 1991) (Amended 1992, 1996, and 1997)

UR. User Requirements

UR.1. Installation Requirements.

UR.1.1. Discharge Rate. – A device shall be so installed that the actual maximum discharge rate will not exceed the rated maximum discharge rate. If necessary, means for flow regulation shall be incorporated in the installation, in which case this shall be fully effective and automatic in operation.

UR.1.2. Length of Discharge Hose. – The length of the discharge hose on a stationary motor-fuel device shall not exceed 5.5 m (18 ft), measured from the outside of the housing of the device to the inlet end of the discharge nozzle, unless it can be demonstrated that a longer hose is essential to permit deliveries to be made to receiving vehicles or vessels. Unnecessarily remote location of a device shall not be accepted as justification for an abnormally long hose.

(Amended 1991)

UR.2. Use Requirements.

UR.2.1. Return of Indication and Recording Elements to Zero. – The primary indicating elements (visual), and the primary recording elements when these are returnable to zero, shall be returned to zero before each delivery.

UR.2.2. Condition of Fill of Discharge Hose. – The discharge hose shall be completely filled with liquid before the “zero” condition is established prior to the start of a commercial delivery, whether this condition is established by resetting the primary indicating elements to zero indication or by recording the indications of the primary indicating elements. (Also see UR.2.1. Return of Indication and Recording Elements to Zero.)

UR.2.3. Vapor-Return Line. – During any metered delivery of liquefied petroleum gas from a supplier’s tank to a receiving container, there shall be no vapor-return line from the receiving container to the supplier’s tank:

- (a) in the case of any receiving container to which normal deliveries can be made without the use of such vapor-return line; or
- (b) in the case of any new receiving container when the ambient temperature is below 90 °F.

UR.2.4. Temperature Compensation.

UR.2.4.1. Use of Automatic Temperature Compensators. – If a device is equipped with an automatic temperature compensator, this shall be connected, operable, and in use at all times. Such automatic temperature compensator may not be removed, nor may a compensated device be replaced with an uncompensated device, without the written approval of the weights and measures authority having jurisdiction over the device.

UR.2.4.2. Temperature Compensated Sale. – All sales of liquefied petroleum gas in a liquid state, when the quantity is determined by an approved measuring system equipped with a temperature-compensating mechanism, or by weight and converted to liters or gallons, or by a calibrated container, shall be in terms of liters or the U.S. gallon of 231 in³ at 15 °C (60 °F).

(Added 1984)

UR.2.4.3. Invoices. – Any invoice based on a reading of a device that is equipped with an automatic temperature compensator or based on a weight converted to gallons, or based on the volume of a calibrated container, shall have shown thereon that the volume delivered has been adjusted to the volume at 15 °C (60 °F).

(Amended 1984)

UR.2.4.4. Automated Temperature-Compensating Systems. – Means for determining the temperature of measured liquid in an automatic temperature-compensating system shall be so designed and located that, in any “usual and customary” use of the system, the resulting indications and/or recorded representations are within applicable tolerances.

(Added 1987)

UR.2.5. Ticket in Printing Device. – A ticket shall not be inserted into a device equipped with a ticket printer until immediately before a delivery is begun, and in no case shall a ticket be in the device when the vehicle is in motion while on a public street, highway, or thoroughfare.

UR.2.6. Ticket Printer; Customer Ticket. – Vehicle-mounted metering systems shall be equipped with a ticket printer. The ticket printer shall be used for all sales; a copy of the ticket issued by the device shall be left with the customer at the time of delivery or as otherwise specified by the customer.

(Added 1992)

THIS PAGE INTENTIONALLY LEFT BLANK

MARKUP COPY

Section 3.33. Hydrocarbon Gas Vapor-Measuring Devices⁴⁰

A. Application

A.1. General. – This code applies to devices used for the measurement of hydrocarbon gas in the vapor state, such as propane, propylene, butanes, butylenes, ethane, methane, natural gas, and any other hydrocarbon gas/air mix. (Amended 1984, 1986, 1988, and 1991)

A.2. Exceptions. – This code does not apply to:

- (a) Liquid-measuring devices used for dispensing liquefied petroleum gases in liquid form (~~(Also see Section 3.32. Code for Liquefied Petroleum Gas and Anhydrous Ammonia Liquid-Measuring Devices).~~)
- (b) Natural, liquefied petroleum, and manufactured-gas-vapor meters when these are operated in a public utility system.
- (c) Mass flow meters (~~(Also see Section 3.37. Code for Mass Flow Meters).~~) (Added 1994)

A.3. Additional Code Requirements. – In addition to the requirements of this code, Hydrocarbon Gas Vapor-Measuring Devices shall meet the requirements of Section 1.10. General Code.

S. Specifications

S.1. Design of Indicating and Recording Elements and of Recorded Representations.

S.1.1. Primary Elements.

S.1.1.1. General. – A device shall be equipped with a primary indicating element and may also be equipped with a primary recording element.

S.1.1.2. Units. – A volume-measuring device shall indicate, and record if equipped to record, its deliveries in terms of cubic meters or cubic feet, or multiple or decimal subdivisions of cubic meters or cubic feet.

(Amended 1972 and 1991)

S.1.1.3. Value of Smallest Unit. – The value of the smallest unit of indicated delivery, and recorded delivery if the device is equipped to record, shall not exceed:

- (a) 1 m³ (1000 dm³) (100 ft³) when the maximum rated gas capacity is less than 280 m³/h (10 000 ft³/h);
- (b) 10 m³ (1000 ft³) when the maximum rated gas capacity is 280 m³/h (10 000 ft³/h) up to, but not including, 1700 m³/h (60 000 ft³/h); and
- (c) 100 m³ (10 000 ft³) when the maximum rated gas capacity is 1700 m³/h (60 000 ft³/h) or more.

(Amended 1972, 1988, and 1991)

¹Title changed 1986.

S.1.1.4. Advancement of Indicating and Recording Elements. – Primary indicating and recording elements shall advance digitally or continuously and be susceptible to advancement only by the mechanical operation of the device.

S.1.1.5. Proving Indicator. – Devices rated less than 280 m³/h (10 000 ft³/h) gas capacity shall be equipped with a proving indicator measuring 0.025, 0.05, 0.1, 0.2, or 0.25 m³ per revolution, (1, 2, 5, or 10 ft³ per revolution) for testing the meter. Devices with larger capacities shall be equipped as follows:

- (a) Devices rated 280 m³ (10 000 ft³) up to but not including 1700 m³/h (60 000 ft³/h) gas capacity shall be equipped with a proving indicator measuring not greater than 1 m³ (100 ft³) per revolution.
- (b) Devices rated 1700 m³/h (60 000 ft³/h) gas capacity or more shall be equipped with a proving indicator measuring not more than 10 m³ (1000 ft³) per revolution.

The test circle of the proving indicator shall be divided into ten equal parts. Additional subdivisions of one or more of such equal parts may be made.

(Amended 1973 and 1988)

S.1.2. Graduations.

S.1.2.1. Length. – Graduations shall be so varied in length that they may be conveniently read.

S.1.2.2. Width. – In any series of graduations, the width of a graduation shall in no case be greater than the width of the minimum clear interval between graduations, and in no case should it exceed 1.0 mm (0.04 in) for indicating elements and 0.5 mm (0.02 in) for proving circles.

S.1.2.3. Clear Interval Between Graduations. – The clear interval shall be not less than 1.0 mm (0.04 in). If the graduations are not parallel, the measurement shall be made:

- (a) along the line of relative movement between the graduations at the end of the indicator; or
- (b) if the indicator is continuous, at the point of widest separation of the graduations.

S.1.3. Indicators.

S.1.3.1. Symmetry. – The index of an indicator shall be symmetrical with respect to the graduations, at least throughout that portion of its length associated with the graduations.

S.1.3.2. Length. – The index of an indicator shall reach to the finest graduations with which it is used.

S.1.3.3. Width. – The width of the index of an indicator in relation to the series of graduations with which it is used shall be not greater than the:

- (a) *width of the narrowest graduation;* and*
*[*Nonretroactive as of January 1, 2002]*
 (Amended 2001)

- (b) width of the minimum clear interval between graduations.

When the index of an indicator extends along the entire length of a graduation, that portion of the index of the indicator that may be brought into coincidence with the graduation shall be of the same width throughout the length of the index that coincides with the graduation.

S.1.3.4. Clearance. – The clearance between the index of an indicator and the graduations shall in no case be more than 1.5 mm (0.06 in).

S.1.3.5. Parallax. – Parallax effects shall be reduced to the practicable minimum.

S.2. Design of Measuring Elements.

S.2.1. Pressure Regulation. – The vapor should be measured at a normal gauge pressure (psig) of:
(Amended 1991)

- (a) 2740 Pa ± 685 Pa (11 in of water column (0.40 psig) ± 2.75 in of water column (0.10 psig)) for liquefied petroleum gas vapor; or
- (b) 1744 Pa ± 436 Pa (7 in of water column (0.25 psig) ± 1.75 in of water column (0.06 psig)) for natural and manufactured gas.

When vapor is measured at a pressure other than what is specified above for the specific product, a volume multiplier shall be applied within the meter or to the billing invoice based on the following equation:

$$VPM = \frac{AAP + GP}{AAP + NGP}$$

Where:

VPM = Volume pressure multiplier
 AAP = Assumed atmospheric pressure in Pa or psia
 GP = Gauge pressure in Pa or psig
 NGP = Normal gauge pressure in Pa or psig

The assumed atmospheric pressure is to be taken from Tables 2 and 2M.

When liquefied petroleum gas vapor is measured at a pressure of 6900 Pa (1 psig) or more, the delivery pressure shall be maintained within ± 1725 Pa (± 0.25 psig).

Pressure variations due to regulator lock off shall not increase the operating pressure by more than 25 %.
(Amended 1980, 1984, and 1991)

S.2.2. Provision for Sealing. – Adequate provision shall be made for applying security seals in such a manner that no adjustment or interchange may be made of any measurement element.

S.2.3. Maintenance of Vapor State. – A device shall be so designed and installed that the product being measured will remain in a vapor state during passage through the meter.

S.2.4. Automatic Temperature Compensation. – A device may be equipped with an adjustable automatic means for adjusting the indication and registration of the measured volume of vapor product to the volume at 15 °C (60 °F).

S.3. Design of Discharge Lines.

S.3.1. Diversion of Measured Vapor. – No means shall be provided by which any measured vapor can be diverted from the measuring chamber of the meter or the discharge line therefrom.

S.4. Marking Requirements.

S.4.1. Limitations of Use. – If a device is intended to measure accurately only products having particular properties, or to measure accurately only under specific installation or operating conditions, or to

measure accurately only when used in conjunction with specific accessory equipment, these limitations shall be clearly and permanently stated on the device.

S.4.2. Discharge Rates. – A ~~volume measuring~~ device shall be marked to show its rated gas capacity in cubic meters per hour or cubic feet per hour.

S.4.3. Temperature Compensation. – If a device is equipped with an automatic temperature compensator, this shall be indicated on the badge or immediately adjacent to the badge of the device and on the register.

S.4.4. Badge. – A badge affixed in a prominent position on the front of the device shall show the manufacturer's name, serial number and model number of the device, and capacity rate of the device for the particular products that it was designed to meter as recommended by the manufacturer.

N. Notes

N.1. Test Medium. – The device shall be tested with air or the product to be measured.
(Amended 1991)

N.2. Temperature and Volume Change. – Care should be exercised to reduce to a minimum any volume changes. The temperature of the air, bell-prover oil, and the meters under test should be within 1 °C (2 °F) of one another. The devices should remain in the proving room for at least 16 hours before starting any proving operations to allow the device temperature to approximate the temperature of the proving device.

N.3. Test Drafts. – Except for low-flame tests, test drafts shall be at least equal to one complete revolution of the largest capacity proving indicator, and shall in no case be less than 0.05 m³ or 2 ft³. All flow rates shall be controlled by suitable outlet orifices.
(Amended 1973 and 1991)

| Metric Units | | Inch-pound Units | |
|---|-------------------------|--|-------------------------|
| Rated Capacity | Low-Flow Test Rate | Rated Capacity | Low-Flow Test Rate |
| Up to and including 7 m ³ /h | 0.007 m ³ /h | Up to and including 250 ft ³ /h | 0.25 ft ³ /h |
| Over 7 m ³ /h up to and including 14 m ³ /h | 0.014 m ³ /h | Over 250 ft ³ /h up to and including 500 ft ³ /h | 0.50 ft ³ /h |
| Over 14 m ³ /h | 0.1 % of capacity rate | Over 500 ft ³ /h | 0.1 % of capacity rate |

N.4. Test Procedures. – If a device is equipped with an automatic temperature compensator, the proving device reading shall be corrected to 15 °C (60 °F), using an approved table.
(Amended 1972)

N.4.1. Normal Tests. – The normal test of a device shall be made at a rate not to exceed the capacity rate given on the badge of the meter.
(Amended 1988)

N.4.1.1. Automatic Temperature Compensation. – If a device is equipped with an automatic temperature compensator, the quantity of the test draft indication of the standard shall be corrected to 15 °C (60 °F).

N.4.1.2. Repeatability Tests. – Tests for repeatability should include a minimum of three consecutive test drafts of approximately the same size and be conducted under controlled conditions where variations in factors such as temperature, pressure, and flow rate are reduced to the extent that they will not affect the results obtained.

(Added 2002)

N.4.2. Special Tests. – “Special” tests shall be made to develop the operating characteristics of a device and any special elements and accessories attached to or associated with the device. Any test except as set forth in N.4.1. Normal Tests shall be considered a special test.

N.4.2.1. Slow Test. – The device shall be tested at a rate not less than 20 % of the marked capacity rate, or (at the check rate) not less than the minimum flow rate if marked on the device, whichever is less.

(Amended 1988)

N.4.2.2. Low-Flame Test. – The device shall be tested at an extremely low-flow rate as given in Table 1. The test shall consist of passing air at a pressure of 375 Pa (1.5 in water column) through the meter for not less than 60 minutes. The meter shall continue to advance at the conclusion of the test period.

(Amended 1990 and 1991)

N.4.2.3. Pressure Regulation Test. – On devices operating at a pressure of 6900 Pa (1 psig) or more, a pressure regulation test shall be made at both the minimum and maximum use load to determine the proper operation of the regulator and the proper sizing of the piping and dispensing equipment. These tests may include a test of 24 hours during which the pressure is recorded.

(Added 1984)

N.5. Temperature Correction. – Corrections shall be made for any changes in volume resulting from the difference in air temperatures between time of passage through the device and time of volumetric determination in the proving device.

N.6. Frequency of Test. – A hydrocarbon gas vapor-measuring device shall be tested before installation and allowed to remain in service for 10 years from the time last tested without being retested, unless a test is requested by:

- (a) the purchaser of the product being metered;
- (b) the seller of the product being metered; or
- (c) the weights and measures official.

T. Tolerances

T.1. Tolerance Values on Normal Tests and on Special Tests Other Than Low-Flame Tests. – Maintenance and acceptance tolerances for normal and special tests for hydrocarbon gas vapor-measuring devices shall be as shown in Table T.1. Accuracy Classes and Tolerances for Hydrocarbon Gas Vapor-Measuring Devices.

(Amended 1981 and 2003)

| Table T.1. Accuracy Classes and Tolerances for Hydrocarbon Gas Vapor-Measuring Devices | | | | |
|---|---|-----------------------------|------------------------------|-------|
| Accuracy Class | Application | Acceptance Tolerance | Maintenance Tolerance | |
| 3.0 | Gases at low pressure (for example, LPG vapor) | Overregistration | 1.5 % | 1.5 % |
| | | Underregistration | 3.0 % | 3.0 % |

(Added 2003)

T.2. Repeatability. – When multiple tests are conducted at approximately the same flow rate and draft size, the range of the test results for the flow rate shall not exceed 0.9 % and the results of each test shall be within the applicable tolerance. (See also N.4.1.2. Repeatability Test.)

(Added 2002)

UR. User Requirements

UR.1. Installation Requirements.

UR.1.1. Capacity Rate. – A device shall be so installed that the actual maximum flow rate will not exceed the capacity rate except for short durations. If necessary, means for flow regulation shall be incorporated in the installation, in which case this shall be fully effective and automatic in operation.

UR.1.2. Leakage. – The metering system shall be installed and maintained as a pressure-tight and leak-free system.

UR.2. Use Requirements.

UR.2.1. Automatic Temperature Compensation. – A compensated device may not be replaced with an uncompensated device without the written approval of the weights and measures authority having jurisdiction over the device.

UR.2.2. Invoices. – A customer purchasing hydrocarbon gas measured by a vapor meter shall receive from the seller an invoice for each billing period. The invoice shall clearly and separately show the following:

- (a) The opening and closing meter readings and the dates of those readings.
- (b) The altitude correction factor.
- (c) The total cubic meters (cubic feet) billed, corrected for elevation.
- (d) The charge per cubic meter (cubic foot) after correction for elevation.
- (e) All periodic charges independent of the measured gas, such as meter charges, meter reading fees, service charges or a minimum charge for a minimum number of cubic meters (cubic feet).
- (f) The total charge for the billing period.

If the vapor meter is equipped with an automatic temperature compensator, or any other means are used to compensate for temperature, the invoice shall show that the volume has been adjusted to the volume at 15 °C (60 °F).

(Amended 1988 and 1991)

UR.2.3. Correction for Elevation. – The metered volume of gas shall be corrected for changes in the atmospheric pressure with respect to elevation to the standard pressure of 101.56 kPa (14.73 psia). The appropriate altitude correction factor from Table 2M. Corrections for Altitude, Metric Units or Table 2. Corrections for Altitude, Inch-Pound Units shall be used. (The table is modified from NIST Handbook 117.)

(Amended 1988)

Elevation correction factors (ACF) were obtained by using the following equation:

$$ACF = \frac{GP \text{ of gas} + AAP}{\text{base pressure}}$$

Where:

GP = gauge pressure
 AAP = assumed atmospheric pressure
 base pressure = 101.560 kPa = 14.73 psia

2740 Pa = 11 in of water column = 0.397 psig

1744 Pa = 7 in of water column = 0.253 psig

(Added 1988)

UR.2.4. Valves and Test Tee. – *All gas meter installations shall be provided with a shut-off valve located adjacent to and on the inlet side of the meter. In the case of a single meter installation utilizing a liquefied petroleum gas tank, the tank service valve may be used in lieu of the shut-off valve. All gas meter installations shall be provided with a test tee located adjacent to and on the outlet side of the meter.*
 [Nonretroactive as of January 1, 1990]

(Added 1989)

UR.2.5. Use of Auxiliary Heated Vaporizer Systems. – Automatic temperature compensation shall be used on hydrocarbon gas vapor meters equipped with an auxiliary heated vaporizer system unless there is sufficient length of underground piping to provide gas at a uniform temperature to the meter inlet. When required by weights and measures officials, a thermometer well (appropriately protected against freezing) shall be installed immediately up-stream of the meter.

(Added 1990)

| Table 2M. Corrections for Altitude, Metric Units | | | | | | | |
|---|---------|------|----------------------------------|-------------------------------|------------------------------------|--|-------------------------------|
| Elevation (meters) | | | Altitude Correction Factor | | Assumed Atmospheric Pressure | Assumed Atmospheric Pressure Plus Gauge Pressure | |
| | | | 2.74 kPa Gauge Pressure | 1.74 kPa Gauge Pressure | (kPa) | 2.74 kPa Gauge Pressure | 1.74 kPa Gauge Pressure |
| | – 50 to | 120 | 1.02 | 1.01 | 100.85 | 103.59 | 102.58 |
| above | 120 to | 300 | 1.00 | 0.99 | 98.82 | 101.56 | 100.54 |
| above | 300 to | 470 | 0.98 | 0.97 | 96.79 | 99.53 | 98.51 |
| above | 470 to | 650 | 0.96 | 0.95 | 94.76 | 97.50 | 96.48 |
| above | 650 to | 830 | 0.94 | 0.93 | 92.73 | 95.47 | 94.45 |
| above | 830 to | 1020 | 0.92 | 0.91 | 90.70 | 93.44 | 92.42 |
| above | 1020 to | 1210 | 0.90 | 0.89 | 88.66 | 91.40 | 90.39 |
| above | 1210 to | 1400 | 0.88 | 0.87 | 86.63 | 89.37 | 88.36 |
| above | 1400 to | 1590 | 0.86 | 0.85 | 84.60 | 87.34 | 86.33 |
| above | 1590 to | 1790 | 0.84 | 0.83 | 82.57 | 85.31 | 84.29 |
| above | 1790 to | 2000 | 0.82 | 0.81 | 80.54 | 83.28 | 82.26 |
| above | 2000 to | 2210 | 0.80 | 0.79 | 78.51 | 81.25 | 80.23 |
| above | 2210 to | 2420 | 0.78 | 0.77 | 76.48 | 79.22 | 78.20 |
| above | 2420 to | 2640 | 0.76 | 0.75 | 74.45 | 77.19 | 76.17 |
| above | 2640 to | 2860 | 0.74 | 0.73 | 72.41 | 75.15 | 74.15 |
| above | 2860 to | 3080 | 0.72 | 0.71 | 70.38 | 73.12 | 72.12 |
| above | 3080 to | 3320 | 0.70 | 0.69 | 68.35 | 71.09 | 70.08 |
| above | 3320 to | 3560 | 0.68 | 0.67 | 66.32 | 69.06 | 68.05 |
| above | 3560 to | 3800 | 0.66 | 0.65 | 64.29 | 67.03 | 66.01 |
| above | 3800 to | 4050 | 0.64 | 0.63 | 62.26 | 65.00 | 63.98 |
| above | 4050 to | 4310 | 0.62 | 0.61 | 60.23 | 62.97 | 61.95 |
| above | 4310 to | 4580 | 0.60 | 0.59 | 58.20 | 60.94 | 59.92 |

| Table 2. | | | | | | | |
|---|-----------|--------|---|----------------------|---|---|-----------------------------|
| Corrections for Altitude, Inch-Pound Units | | | | | | | |
| Elevation (feet) | | | Altitude Correction Factor | | Assumed Atmospheric Pressure | Assumed Atmospheric Pressure Plus Gauge Pressure | |
| | | | 11 inch WC | 7 inch WC | (psia) | 11 inch WC (psia) | 7 inch WC (psia) |
| | – 150 to | 400 | 1.02 | 1.01 | 14.64 | 15.04 | 14.89 |
| above | 400 to | 950 | 1.00 | 0.99 | 14.35 | 14.74 | 14.60 |
| above | 950 to | 1 550 | 0.98 | 0.97 | 14.05 | 14.45 | 14.30 |
| above | 1 550 to | 2 100 | 0.96 | 0.95 | 13.76 | 14.15 | 14.01 |
| above | 2 100 to | 2 700 | 0.94 | 0.93 | 13.46 | 13.86 | 13.71 |
| above | 2 700 to | 3 300 | 0.92 | 0.91 | 13.17 | 13.56 | 13.42 |
| above | 3 300 to | 3 950 | 0.90 | 0.89 | 12.87 | 13.27 | 13.12 |
| above | 3 950 to | 4 550 | 0.88 | 0.87 | 12.58 | 12.97 | 12.83 |
| above | 4 550 to | 5 200 | 0.86 | 0.85 | 12.28 | 12.68 | 12.53 |
| above | 5 200 to | 5 850 | 0.84 | 0.83 | 11.99 | 12.38 | 12.24 |
| above | 5 850 to | 6 500 | 0.82 | 0.81 | 11.69 | 12.09 | 11.94 |
| above | 6 500 to | 7 200 | 0.80 | 0.79 | 11.40 | 11.79 | 11.65 |
| above | 7 200 to | 7 900 | 0.78 | 0.77 | 11.10 | 11.50 | 11.35 |
| above | 7 900 to | 8 600 | 0.76 | 0.75 | 10.81 | 11.20 | 11.06 |
| above | 8 600 to | 9 350 | 0.74 | 0.73 | 10.51 | 10.91 | 10.76 |
| above | 9 350 to | 10 100 | 0.72 | 0.71 | 10.22 | 10.61 | 10.47 |
| above | 10 100 to | 10 850 | 0.70 | 0.69 | 9.92 | 10.32 | 10.17 |
| above | 10 850 to | 11 650 | 0.68 | 0.67 | 9.63 | 10.03 | 9.88 |
| above | 11 650 to | 12 450 | 0.66 | 0.65 | 9.33 | 9.73 | 9.58 |
| above | 12 450 to | 13 250 | 0.64 | 0.63 | 9.04 | 9.44 | 9.29 |
| above | 13 250 to | 14 100 | 0.62 | 0.61 | 8.75 | 9.14 | 9.00 |
| above | 14 100 to | 14 950 | 0.60 | 0.59 | 8.45 | 8.85 | 8.70 |

THIS PAGE INTENTIONALLY LEFT BLANK

MARKUP COPY

Section 3.34. Cryogenic Liquid-Measuring Devices

A. Application

A.1. General. – This code applies to devices used for the measurement of cryogenic liquids such as, but not limited to oxygen, nitrogen, hydrogen, and argon.

(Amended 1986 and 1995)

A.2. Exceptions. – This code does not apply to the following:

- (a) Devices used for dispensing liquefied petroleum gases (for which see Section 3.32. Code for Liquefied Petroleum Gas and Anhydrous Ammonia Liquid-Measuring Devices).
- (b) Devices used solely for dispensing a product in connection with operations in which the amount dispensed does not affect customer charges.
- (c) Devices used solely for dispensing liquefied natural gas.

(d) Mass flow meters (~~—(Also see Section 3.37. Code for Mass Flow Meters)—~~)
(Added 1994)

A.3. Additional Code Requirements. – In addition to the requirements of this code, Cryogenic Liquid-Measuring Devices shall meet the requirements of Section 1.10. General Code.

S. Specifications

S.1. Design of Indicating and Recording Elements and of Recorded Representations.

S.1.1. Primary Elements.

S.1.1.1. General. – A device shall be equipped with a primary indicating element and may also be equipped with a primary recording element.

S.1.1.2. Units. – A device shall indicate and record, if equipped to record, its deliveries in terms of: kilograms or pounds; liters or gallons of liquid at the normal boiling point of the specific cryogenic product; cubic meters (cubic feet) of gas at a normal temperature of 21 °C (70 °F) and an absolute pressure of 101.325 kPa (14.696 psia); or decimal subdivisions or multiples of the measured units cited above.

(Amended 2002)

S.1.1.3. Value of Smallest Unit. – The value of the smallest unit of indicated delivery, and recorded delivery, if the device is equipped to record, shall not exceed the equivalent of:

(a) for small delivery devices:

- (1) 1 L;
- (2) 0.1 gal;
- (3) 1 kg;
- (4) 1 lb;

- (5) 0.1 m³ of gas; or
 - (6) 10 ft³ of gas.
- (b) for large delivery devices:
- (1) 10 L;
 - (2) 1 gal;
 - (3) 10 kg;
 - (4) 10 lb;
 - (5) 1 m³ of gas; or
 - (6) 100 ft³ of gas.

(Amended 2002)

S.1.1.4. Advancement of Indicating and Recording Elements. – Primary indicating and recording elements shall be susceptible to advancement only by the normal operation of the device. However, a device may be cleared by advancing its elements to zero, but only if:

- (a) the advancing movement, once started, cannot be stopped until zero is reached; or
- (b) in the case of indicating elements only, such elements are automatically obscured until the elements reach the correct zero position.

S.1.1.5. Return to Zero. – Primary indicating and recording elements shall be readily returnable to a definite zero indication. Means shall be provided to prevent the return of primary indicating elements and of primary recording elements beyond their correct zero position.

S.1.2. Graduations.

S.1.2.1. Length. – Graduations shall be so varied in length that they may be conveniently read.

S.1.2.2. Width. – In any series of graduations, the width of a graduation shall in no case be greater than the width of the minimum clear interval between graduations, and the width of main graduations shall be not more than 50 % greater than the width of subordinate graduations. Graduations shall in no case be less than 0.2 mm (0.008 in) in width.

S.1.2.3. Clear Interval Between Graduations. – The clear interval shall be no less than 1.0 mm (0.04 in). If the graduations are not parallel, the measurement shall be made:

- (a) along the line of relative movement between the graduations at the end of the indicator; or
- (b) if the indicator is continuous, at the point of widest separation of the graduations.

(See Also see also S.1.3.6. Travel of Indicator.)

S.1.3. Indicators.

S.1.3.1. Symmetry. – The index of an indicator shall be symmetrical with respect to the graduations, at least throughout that portion of its length associated with the graduations.

S.1.3.2. Length. – The index of an indicator shall reach to the finest graduations with which it is used, unless the indicator and the graduations are in the same plane, in which case the distance between the end

of the indicator and the ends of the graduations, measured along the line of the graduations, shall be not more than 1.0 mm (0.04 in).

S.1.3.3. Width. – The width of the index of an indicator in relation to the series of graduations with which it is used shall be not greater than the:

- (a) *width of the narrowest graduation;* and*
[*Nonretroactive as of January 1, 2002]
(Amended 2001)
- (b) width of the minimum clear interval between graduations.

When the index of an indicator extends along the entire length of a graduation, that portion of the index of the indicator that may be brought into coincidence with the graduation shall be of the same width throughout the length of the index that coincides with the graduation.

S.1.3.4. Clearance. – The clearance between the index of an indicator and the graduations shall in no case be more than 1.5 mm (0.06 in).

S.1.3.5. Parallax. – Parallax effect shall be reduced to the practicable minimum.

S.1.3.6. Travel of Indicator. – If the most sensitive element of the primary indicating element uses an indicator and graduations, the relative movement of these parts corresponding to the smallest indicated value shall be not less than 0.5 mm (0.20 in).

S.1.4. Computing-Type Device.

S.1.4.1. Printed Ticket. – Any printed ticket issued by a device of the computing type on which there is printed the total computed price shall have printed clearly thereon also the total quantity of the delivery and the price per unit.

S.1.4.2. Money-Value Computations. – Money-value computations shall be of the full-computing type in which the money-value at a single unit price, or at each of a series of unit prices, shall be computed for every delivery within either the range of measurement of the device or the range of the computing elements, whichever is less. Value graduations shall be supplied and shall be accurately positioned. The total price shall be computed on the basis of the quantity indicated when the value of the smallest division indicated is equal to or less than the values specified in S.1.1.3. Value of Smallest Unit.

S.1.4.3. Money-Values, Mathematical Agreement. – Any digital money-value indication and any recorded money-value on a computing type device shall be in mathematical agreement with its associated quantity indication or representation to within 1 cent of money-value.

S.2. Design of Measuring Elements.

S.2.1. Vapor Elimination. – A measuring system shall be equipped with an effective vapor eliminator or other effective means to prevent the measurement of vapor that will cause errors in excess of the applicable tolerances. (See Also see Section T. Tolerances.)

S.2.2. Directional Flow Valves. – A valve or valves or other effective means, automatic in operation, to prevent the reversal of flow shall be installed in or adjacent to the measuring device.
(Amended 1978)

S.2.3. Maintenance of Liquid State. – A device shall be so designed that the product being measured will remain in a liquid state during passage through the device.

S.2.4. Automatic Temperature or Density Compensation. – A device shall be equipped with automatic means for adjusting the indication and/or recorded representation of the measured quantity of the product, to indicate and/or record in terms of: kilograms or pounds; or liters or gallons of liquid at the normal boiling point of the specific cryogenic product; or the equivalent cubic meters (cubic feet) of gas at a normal temperature of 21 °C (70 °F) and an absolute pressure of 101.325 kPa (14.696 lb/in² absolute). *When a compensator system malfunctions, the indicating and recording elements may indicate and record in uncompensated volume if the mode of operation is clearly indicated, e.g., by a marked annunciator, recorded statement, or other obvious means.**

*[*Nonretroactive as of January 1, 1992]*

(Amended 1991 and 2002)

S.2.5. Provision for Sealing. – Adequate provision shall be made for an approved means of security (e.g., data change audit trail) or for physically applying a security seal in such a manner that requires the security seal to be broken before an adjustment or interchange may be made of:

- (a) any measuring or indicating element;
- (b) any adjustable element for controlling delivery rate when such rate tends to affect the accuracy of deliveries;
- (c) any automatic temperature or density compensating system; and
- (d) any metrological parameter that will affect the metrological integrity of the device or system.

When applicable, any adjusting mechanism shall be readily accessible for purposes of affixing a security seal.

*[Audit trails shall use the format set forth in Table S.2.5. Categories of Device and Methods of Sealing]**

*[*Nonretroactive as of January 1, 1995]*

(Amended 2006)

| Table S.2.5. Categories of Device and Methods of Sealing | |
|--|---|
| Categories of Device | Methods of Sealing |
| Category 1: No remote configuration capability. | Seal by physical seal or two event counters: one for calibration parameters and one for configuration parameters. |
| Category 2: Remote configuration capability, but access is controlled by physical hardware. The device shall clearly indicate that it is in the remote configuration mode and record such message if capable of printing in this mode or shall not operate while in this mode. | The hardware enabling access for remote communication must be on-site. The hardware must be sealed using a physical seal or an event counter for calibration parameters and an event counter for configuration parameters. The event counters may be located either at the individual measuring device or at the system controller; however, an adequate number of counters must be provided to monitor the calibration and configuration parameters of the individual devices at a location. If the counters are located in the system controller rather than at the individual device, means must be provided to generate a hard copy of the information through an on-site device. |
| Category 3: Remote configuration capability access may be unlimited or controlled through a software switch (e.g., password). The device shall clearly indicate that it is in the remote configuration mode and record such message if capable of printing in this mode or shall not operate while in this mode. | An event logger is required in the device; it must include an event counter (000 to 999), the parameter ID, the date and time of the change, and the new value of the parameter. A printed copy of the information must be available through the device or through another on-site device. The event logger shall have a capacity to retain records equal to 10 times the number of sealable parameters in the device, but not more than 1000 records are required. (Note: Does not require 1000 changes to be stored for each parameter.) |

[Nonretroactive as of January 1, 1995]

(Table Added 2006)

S.3. Design of Discharge Lines and Discharge Line Valves.

S.3.1. Diversion of Measured Liquid. – No means shall be provided by which any measured liquid can be diverted from the measuring chamber of the device or the discharge line therefrom, except that a manually controlled outlet that may be opened for purging or draining the measuring system shall be permitted. Effective means shall be provided to prevent the passage of liquid through any such outlet during normal operation of the device and to indicate clearly and unmistakably when the valve controls are so set as to permit passage of liquid through such outlet.

S.3.2. Discharge Hose. – The discharge hose of a measuring system shall be of the completely draining dry-hose type.

S.4. Marking Requirements.

S.4.1. Limitation of Use. – If a measuring system is intended to measure accurately only liquids having particular properties, or to measure accurately only under specific installation or operating conditions, or to

measure accurately only when used in conjunction with specific accessory equipment, these limitations shall be clearly and permanently marked on the device.

S.4.2. Discharge Rates. – A meter shall be marked to show its designed maximum and minimum discharge rates.

S.4.3. Temperature or Density Compensation. – Devices equipped with an automatic temperature or density compensator, shall be clearly and conspicuously marked on the primary indicating elements, recording elements, and recorded representations to show that the quantity delivered has been adjusted to the conditions specified in S.2.4. Automatic Temperature or Density Compensation.

N. Notes

N.1. Test Liquid. – A meter shall be tested with the liquid to be commercially measured except that, in a type evaluation examination, nitrogen may be used.

N.2. Vaporization and Volume Change. – Care shall be exercised to reduce to a minimum vaporization and volume changes. When testing by weight, the weigh tank and transfer systems shall be pre-cooled to liquid temperature prior to the start of the test to avoid the venting of vapor from the vessel being weighed.

N.3. Test Drafts.

N.3.1. Gravimetric Test. – Weight test drafts shall be equal to at least the amount delivered by the device in 2 minutes at its maximum discharge rate, and shall in no case be less than 907 kg (2000 lb).

N.3.2. Transfer Standard Test. – When comparing a meter with a calibrated transfer standard, the test draft shall be equal to at least the amount delivered by the device in ~~2~~**two** minutes at its maximum discharge rate, and shall in no case be less than 180 L (50 gal) or equivalent thereof. When testing uncompensated volumetric meters in a continuous recycle mode, appropriate corrections shall be applied if product conditions are abnormally affected by this test mode.

(Amended 1976)

N.4. Density. – Temperature and pressure of the metered test liquid shall be measured during the test for the determination of density or volume correction factors when applicable. For Liquid Density and Volume Correction Factors (with respect to temperature and pressure) the publications shown in Table N.4. Density or Volume Correction Factors shall apply.

(Amended 1986 and 2004)

| Table N.4. Density or Volume Correction Factors | |
|---|---|
| Cryogenic Liquid | Publication |
| Argon | Tegeler, Ch., Span, R., Wagner, W. “A New Equation of State for Argon Covering the Fluid Region for Temperatures from the Melting Line to 700 K at Pressures up to 1000 Mpa.” <i>J. Phys. Chem. Ref. Data</i> , 28(3):779-850, 1999. |
| Ethylene | Smukala, J., Span, R., Wagner, W. “New Equation of State for Ethylene Covering the Fluid Region for Temperatures from the Melting Line to 450 k at Pressures up to 300 Mpa.” <i>J. Phys. Chem. Ref. Data</i> , 29(5):1053-1122, 2000. |
| Nitrogen | Span, R., Lemmon, E.W., Jacobsen, R.T, Wagner, W., and Yokozeki, A. “A Reference Thermodynamic Property Formulation for Nitrogen.” <i>J. Phys. Chem. Ref. Data</i> , Volume 29, Number 6, pp. 1361-1433, 2000. |
| Oxygen | Schmidt, R., Wagner, W. “A New Form of the Equation of State for Pure Substances and its Application to Oxygen.” <i>Fluid Phase Equilib.</i> , 19:175-200, 1985 |
| Hydrogen | Leachman, J. W., Jacobsen, R. T., Lemmon, E.W., and Penoncello, S.G. “Fundamental Equations of State for Parahydrogen, Normal Hydrogen, and Orthohydrogen” <i>J. Phys. Chem. Ref. Data</i> , Volume 38, Number 3, pp. 565, 2009. |
| <p>Note: A complete database program containing all of the most recent equations for calculating density for various cryogenic liquids is available at www.nist.gov/srd/nist23.cfm. There is a fee for download of this database.</p> | |

(Added 2004)

N.5. Testing Procedures.

N.5.1. Normal Tests. – The “normal” tests of a device shall be made over a range of discharge rates that may be anticipated under the conditions of installation.

N.5.1.1. Repeatability Tests. – Tests for repeatability should include a minimum of three consecutive test drafts of approximately the same size and be conducted under controlled conditions where variations in factors such as temperature, pressure, and flow rate are reduced to the extent that they will not affect the results obtained.

(Added 2001)

N.5.2. Special Tests. – Any test except as set forth in N.5.1. Normal Tests shall be considered a “special” test. Tests shall be conducted, if possible, to evaluate any special elements or accessories attached to or associated with the device. A device shall be tested at a minimum discharge rate of:

- (a) 50 % of the maximum discharge rate developed under the conditions of installation, or the minimum discharge rate marked on the device, whichever is less; or
- (b) the lowest discharge rate practicable under conditions of installation.

Special tests may be conducted to develop any characteristics of the device that are not normally anticipated under the conditions of installation.

N.6. Temperature Correction. – Corrections shall be made for any changes in volume resulting from the differences in liquid temperature between time of passage through the meter and time of volumetric determination of test draft.

N.7. Automatic Temperature or Density Compensation. – When a device is equipped with an automatic temperature or density compensator, the compensator shall be tested by comparing the quantity indicated or recorded by the device (with the compensator connected and operating) with the actual delivered quantity corrected to the normal boiling point of the cryogenic product being measured or to the normal temperature and pressure as applicable.

T. Tolerances

T.1. Application.

T.1.1. To Underregistration and to Overregistration. – The tolerances hereinafter prescribed shall be applied to errors of underregistration and errors of overregistration.

T.2. Tolerance Values. – The maintenance and acceptance tolerances for normal and special tests shall be as shown in Table T.2. Accuracy Classes and Tolerances for Cryogenic Liquid-Measuring Devices.

(Amended 2003)

| Accuracy Class | Application | Acceptance Tolerance | Maintenance Tolerance | Special Test Tolerance |
|-----------------------|---|-----------------------------|------------------------------|-------------------------------|
| 2.5 | Cryogenic products; liquefied compressed gases other than liquid carbon dioxide | 1.5 % | 2.5 % | 2.5 % |

(Added 2003)

T.3. On Tests Using Transfer Standards. – To the basic tolerance values that would otherwise be applied, there shall be added an amount equal to two times the standard deviation of the applicable transfer standard when compared to a basic reference standard.

(Added 1976)

T.4. Repeatability. – When multiple tests are conducted at approximately the same flow rate and draft size, the range of the test results for the flow rate shall not exceed 40 % of the absolute value of the maintenance tolerance and the results of each test shall be within the applicable tolerance. ~~See also~~ **Also see** N.5.1.1. Repeatability Tests.

(Added 2001)

UR. User Requirements

UR.1. Installation Requirements.

UR.1.1. Discharge Rate. – A device shall be so installed that the actual maximum discharge rate will not exceed the rated maximum discharge rate. If necessary, means for flow regulation shall be incorporated in the installation.

UR.1.2. Length of Discharge Hose. – The discharge hose shall be of such a length and design as to keep vaporization of the liquid to a minimum.

UR.1.3. Maintenance of Liquid State. – A device shall be so installed and operated that the product being measured shall remain in the liquid state during passage through the meter.

UR.2. Use Requirements.

UR.2.1. Return of Indicating and Recording Elements to Zero. – The primary indicating elements (visual) and the primary recording elements shall be returned to zero immediately before each delivery.

UR.2.2. Condition of Discharge System. – The discharge system, up to the measuring element, shall be precooled to liquid temperatures before a “zero” condition is established prior to the start of a commercial delivery.

UR.2.3. Vapor Return Line. – A vapor return line shall not be used during a metered delivery.
(Amended 1976)

UR.2.4. Drainage of Discharge Line. – On a dry-hose system, upon completion of a delivery, the vendor shall leave the discharge line connected to the receiving container with the valve adjacent to the meter in the closed position and the valve at the discharge line outlet in the open position for a period of at least:

- (a) 1 minute for small delivery devices; and
- (b) 3 minutes for large delivery devices,

to allow vaporization of some product in the discharge line to force the remainder of the product in the line to flow into the receiving container.

(Amended 1976)

UR.2.5. Conversion Factors. – Established conversion values (see Also see references in Table N.4. Density or Volume Correction Factors⁴¹) shall be used whenever metered liquids are to be billed in terms of:

- (a) kilograms or pounds based on a meter indication of liters, gallons, cubic meters of gas, or cubic feet of gas;
- (b) cubic meters or cubic feet of gas based on a meter indication of liters or gallons, kilograms, or pounds; or
- (c) liters or gallons based on a meter indication of kilograms or pounds, cubic meters of gas or cubic feet of gas.

All sales of cryogenics shall be based on either kilograms or pounds, liters or gallons of liquid at NBP⁴¹, cubic meters of gas or cubic feet of gas at NTP¹.

(Amended 1986)

UR.2.6. Temperature or Density Compensation.

UR.2.6.1. Use of Automatic Temperature or Density Compensators. – If a device is equipped with an automatic temperature or density compensator, this shall be connected, operable, and in use at all times. Such automatic temperature or density compensator may not be removed, nor may a compensated device be replaced with an uncompensated device, without the written approval of the weights and measures authority having jurisdiction over the device.

⁴¹ See Appendix D, Definitions.

UR.2.6.2. Tickets or Invoices. – Any written invoice or printed ticket based on a reading of a device that is equipped with an automatic temperature or density compensator shall have shown thereon that the quantity delivered has been adjusted to the quantity at the NBP of the specific cryogenic product or the equivalent volume of gas at NTP.

UR.2.6.3. Printed Ticket. – Any printed ticket issued by a device of the computing type on which there is printed the total computed price, the total quantity of the delivery, or the price per unit, shall also show the other two values (either printed or in clear hand script).

UR.2.6.4. Ticket in Printing Device. – A ticket shall not be inserted into a device equipped with a ticket printer until immediately before a delivery is begun, and in no case shall a ticket be in the device when the vehicle is in motion while on a public street, highway, or thoroughfare.

UR.2.7. Pressure of Tanks with Volumetric Metering Systems without Temperature Compensation. – When the saturation pressure of the product in the vendor's tank exceeds 240 kPa (35 psia), a correction shall be applied to the written invoice or printed ticket using the appropriate tables as listed in Table N.4. Density or Volume Correction Factors; or the saturation pressure shall be reduced to 207 kPa (30 psia) (if this can be safely accomplished) prior to making a delivery.

(Added 1976)

Section 3.35. Milk Meters

A. Application

A.1. General. – This code applies to devices used for the measurement of milk; generally applicable to, but not limited to, meters used in dairies, milk processing plants, and cheese factories, to measure incoming bulk milk.

A.2. Exceptions. – This code does not apply to mass flow meters ~~(. (Also see Section 3.37. Code for Mass Flow Meters).)~~

(Added 1994)

A.3. Additional Code Requirements. – In addition to the requirements of this code, Milk Meters shall meet the requirements of Section 1.10. General Code.

S. Specifications

S.1. Design of Indicating and Recording Elements and of Recorded Representations.

S.1.1. Primary Elements.

S.1.1.1. General. – A meter shall be equipped with a primary indicating element and may also be equipped with a primary recording element.

S.1.1.2. Units.

- (a) A meter shall indicate, and record if the meter is equipped to record, its deliveries in terms of liters or gallons. Fractional parts of the liter shall be in terms of decimal subdivisions. Fractional parts of the gallon shall be in terms of either decimal or binary subdivisions.
- (b) When it is an industry practice to purchase and sell milk by weight based upon 1.03 kg/L (8.6 lb/gal), the primary indicating element may indicate in kilograms or pounds. The weight value division shall be a decimal multiple or submultiple of 1, 2, or 5. Fractional parts of the kilogram or pound shall be in decimal subdivisions. ~~(See Also see S.4.5. Conversion Factor).~~

S.1.1.3. Value of Smallest Unit. – The value of the smallest unit of indicated quantity and recorded quantity, if the meter is equipped to record, shall not exceed the equivalent of:

- (a) 0.5 L or 0.5 kg (1 pt or 1 lb) when measuring quantities less than or equal to 4000 L or 4000 kg (1000 gal or 8600 lb); or
- (b) 5 L or 5 kg (1 gal or 10 lb) when measuring quantities in excess of 4000 L or 4000 kg (1000 gal or 8600 lb).

(Amended 1989)

S.1.1.4. Advancement of Indicating and Recording Elements. – Primary indicating and recording elements shall be susceptible to advancement only by the mechanical operation of the meter. However, a meter may be cleared by advancing its elements to zero, but only if:

- (a) the advancing movement, once started, cannot be stopped until zero is reached; or
- (b) in the case of indicating elements only, such elements are automatically obscured until the elements reach the correct zero position.

S.1.1.5. Return to Zero. – Primary indicating elements and primary recording elements, if the device is equipped to record, shall be readily returnable to a definite zero indication. Means shall be provided to prevent the return of the primary indicating elements and the primary recording elements, if the device is so equipped, beyond their correct zero position.

S.1.1.6. Indication of Measurement. – A meter shall be constructed to show automatically its initial zero condition and the volume measured up to the nominal capacity of the device.

S.1.2. Graduations.

S.1.2.1. Length. – Graduations shall be so varied in length that they may be conveniently read.

S.1.2.2. Width. – In any series of graduations, the width of a graduation shall in no case be greater than the width of the minimum clear interval between graduations, and the width of main graduations shall be not more than 50 % greater than the width of subordinate graduations. Graduations shall in no case be less than 0.2 mm (0.008 in) in width.

S.1.2.3. Clear Interval between Graduations. – The clear interval shall be not less than 1.0 mm (0.04 in). If the graduations are not parallel, the measurement shall be made:

- (a) along the line of relative movement between the graduations at the end of the indicator; or
- (b) if the indicator is continuous, at the point of widest separation of the graduations.

S.1.3. Indicators.

S.1.3.1. Symmetry. – The index of an indicator shall be symmetrical with respect to the graduations, at least throughout that portion of its length associated with the graduations.

S.1.3.2. Length. – The index of an indicator shall reach to the finest graduations with which it is used, unless the indicator and the graduations are in the same plane, in which case the distance between the end of the indicator and the ends of the graduations, measured along the line of graduations, shall be not more than 1.0 mm (0.04 in).

S.1.3.3. Width. – The width of the index of an indicator in relation to the series of graduations with which it is used shall be not greater than:

- (a) *the width of the narrowest graduation;** and
[*Nonretroactive as of January 1, 2002]
(Amended 2001)
- (b) the width of the minimum clear interval between graduations.

When the index of an indicator extends along the entire length of a graduation, that portion of the index of the indicator that may be brought into coincidence with the graduation shall be of the same width throughout the length of the index that coincides with the graduation.

S.1.3.4. Clearance. – The clearance between the index of an indicator and the graduations shall in no case be more than 1.5 mm (0.06 in).

S.1.3.5. Parallax. – Parallax effects shall be reduced to the practicable minimum.

S.1.3.6. Travel of Indicator. – If the most sensitive element of the primary indicating element utilizes an indicator and graduations, the relative movement of these parts corresponding to the smallest indicated value shall be not less than 5 mm (0.20 in).

S.1.4. Computing-Type Devices.

S.1.4.1. Display of Unit Price. – In a device of the computing type, means shall be provided for displaying on the outside of the device, and in close proximity to the display of the total computed price, the price per unit at which the device is set to compute.

S.1.4.2. Printed Ticket. – If a computing-type device issues a printed ticket which displays the total computed price, the ticket also shall have printed clearly thereon the total quantity of the delivery, the appropriate fraction of the quantity, and the price per unit of quantity.

(Amended 1989)

S.1.4.3. Money-Value Computations. – Money-value computations shall be of the full-computing type in which the money-value at a single unit price, or at each of a series of unit prices, shall be computed for every delivery within either the range of measurement of the device or the range of the computing elements, whichever is less. Value graduations shall be supplied and shall be accurately positioned. The value of each graduated interval shall be 1 cent.

S.1.4.4. Money-Values, Mathematical Agreement. – Any digital money-value indication and any recorded money-value on a computing-type device shall be in mathematical agreement with its associated quantity indicating or representation to within 1 cent of money-value.

S.2. Design of Measuring Elements.

S.2.1. Vapor Elimination. – A metering system shall be equipped with an effective vapor eliminator or other effective means automatic in operation to prevent the passage of vapor and air through the meter. Vent lines from the air (or vapor) eliminator shall be made of metal tubing or some other suitably rigid material.

S.2.2. Maintaining Flooded Condition. – The vent on the vapor eliminator shall be positioned or installed in such a manner that the vapor eliminator cannot easily be emptied between uses.

S.2.3. Provision for Sealing. – Adequate provision shall be made for an approved means of security (e.g., data change audit trail) or for physically applying a security seal in such a manner that requires the security seal to be broken before an adjustment or interchange may be made of any:

- (a) measuring element or indicating element;
- (b) adjustable element for controlling delivery rate, when such rate tends to affect the accuracy of deliveries; and
- (c) metrological parameter that will affect the metrological integrity of the device or system.

When applicable, the adjusting mechanism—register shall be readily accessible for purposes of affixing a security seal.

*[Audit trails shall use the format set forth in Table S.2.3. Categories of Device and Methods of Sealing]**

*[*Nonretroactive as of January 1, 1995]*

(Amended 2006)

| Table S.2.3. Categories of Device and Methods of Sealing | |
|---|---|
| Categories of Device | Methods of Sealing |
| <p>Category 1: <i>No remote configuration capability.</i></p> | <p><i>Seal by physical seal or two event counters: one for calibration parameters and one for configuration parameters.</i></p> |
| <p>Category 2: <i>Remote configuration capability, but access is controlled by physical hardware.</i></p> <p><i>The device shall clearly indicate that it is in the remote configuration mode and record such message if capable of printing in this mode or shall not operate while in this mode.</i></p> | <p><i>The hardware enabling access for remote communication must be on-site. The hardware must be sealed using a physical seal or an event counter for calibration parameters and an event counter for configuration parameters. The event counters may be located either at the individual measuring device or at the system controller; however, an adequate number of counters must be provided to monitor the calibration and configuration parameters of the individual devices at a location. If the counters are located in the system controller rather than at the individual device, means must be provided to generate a hard copy of the information through an on-site device.</i></p> |
| <p>Category 3: <i>Remote configuration capability access may be unlimited or controlled through a software switch (e.g., password).</i></p> <p><i>The device shall clearly indicate that it is in the remote configuration mode and record such message if capable of printing in this mode or shall not operate while in this mode.</i></p> | <p><i>An event logger is required in the device; it must include an event counter (000 to 999), the parameter ID, the date and time of the change, and the new value of the parameter. A printed copy of the information must be available through the device or through another on-site device. The event logger shall have a capacity to retain records equal to 10 times the number of sealable parameters in the device, but not more than 1000 records are required. (Note: Does not require 1000 changes to be stored for each parameter.)</i></p> |

[Nonretroactive as of January 1, 1995]

(Table Added 2006)

S.2.4. Directional Flow Valves. – Valves intended to prevent reversal of flow shall be automatic in operation.

S.3. Design of Intake Lines.

S.3.1. Diversion of Liquid to be Measured. – No means shall be provided by which any liquid can be diverted from the supply tank to the receiving tank without being measured by the device. A manually controlled outlet that may be opened for purging or draining the measuring system shall be permitted. Effective means shall be provided to prevent passage of liquid through any such outlet during normal operation of the measuring system.

(Amended 1994)

S.3.2. Intake Hose. – The intake hose shall be:

- (a) of the dry-hose type;
- (b) adequately reinforced;

(c) not more than 6 m (20 ft) in length unless it can be demonstrated that a longer hose is essential to permit transfer from a supply tank; and

(d) connected to the pump at horizontal or above to permit complete drainage of the hose.

(Amended 1991)

S.4. Marking Requirements.

S.4.1. Limitation of Use. – If a meter is intended to measure accurately only liquids having particular properties, or to measure accurately only under specific installation or operating conditions, or to measure accurately only when used in conjunction with specific accessory equipment, these limitations shall be clearly and permanently stated on the meter.

S.4.2. Discharge Rates. – A meter shall be marked to show its designed maximum and minimum discharge rates. The marked minimum discharge rate shall not exceed 20 % of the marked maximum discharge rate.

Note: ~~See~~ Also see example in Section 3.30. Liquid-Measuring Devices Code, paragraph S.4.4.1. Discharge Rates.

(Added 2003)

S.4.3. Measuring Components. – All components that affect the measurement of milk that are disassembled for cleaning purposes shall be clearly and permanently identified with a common serial number.

S.4.4. Flood Volume. – When applicable, the volume of product (to the nearest minimum division of the meter) necessary to flood the system when dry shall be clearly, conspicuously, and permanently marked on the air eliminator.

S.4.5. Conversion Factor. – When the conversion factor of 1.03 kg/L (8.6 lb/gal) is used to convert the volume of milk to weight, the conversion factor shall be clearly marked on the primary indicating element and recorded on the delivery ticket.

N. Notes

N.1. Test Liquid.

(a) A meter shall be tested with the liquid to be commercially measured or with a liquid of the same general physical characteristics. Following a satisfactory examination, the weights and measures official should attach a seal or tag indicating the product used during the test.

(Amended 1989)

(b) A milk measuring system shall be tested with the type of milk to be measured when the accuracy of the system is affected by the characteristics of milk (e.g., positive displacement meters).

(Added 1989)

N.2. Evaporation and Volume Change. – Care shall be exercised to reduce to a minimum, evaporation losses and volume changes resulting from changes in temperature of the test liquid.

N.2.1. Temperature Correction. – Corrections shall be made for any changes in volume resulting from the differences in liquid temperatures between time of passage through the meter and time of volumetric determination in the test measure. When adjustments are necessary, appropriate tables should be used.

N.3. Test Drafts. – Test drafts should be equal to at least the amount delivered by the device in one minute at its maximum discharge rate, and shall in no case be less than 400 L or 400 kg (100 gal or 1 000 lb).

(Amended 1989)

N.4. Testing Procedures.

N.4.1. Normal Tests. – The “normal” test of a meter shall be made at the maximum discharge rate that may be anticipated under the conditions of the installation. The “normal” test shall include a determination of the effectiveness of the air elimination system.

N.4.1.1. Repeatability Tests. – Tests for repeatability should include a minimum of three consecutive test drafts of approximately the same size and be conducted under controlled conditions where variations in factors such as temperature, pressure, and flow rate are reduced to the extent that they will not affect the results obtained.

(Added 2002)

N.4.2. Special Tests. – “Special” tests shall be made to develop the operating characteristics of a device and any special elements and accessories attached to or associated with the device. Any test except as set forth in N.4.1. Normal Tests shall be considered a special test.

N.4.3. System Capacity. – The test of a milk-metering system shall include the verification of the volume of product necessary to flood the system as marked on the air eliminator.

T. Tolerances

T.1. Application.

T.1.1. To Underregistration and to Overregistration. – The tolerances hereinafter prescribed shall be applied to errors of underregistration and errors of overregistration.

T.2. Tolerance Values. – Maintenance and acceptance tolerances shall be as shown in Table 1. Tolerances for Milk Meters.

(Amended 1989)

| Table 1. Tolerances for Milk Meters | | |
|--|--|--|
| Indication | Maintenance | Acceptance |
| gallons | gallons | gallons |
| 100 | 0.5 | 0.3 |
| 200 | 0.7 | 0.4 |
| 300 | 0.9 | 0.5 |
| 400 | 1.1 | 0.6 |
| 500 | 1.3 | 0.7 |
| Over 500 | Add 0.002 gallon per indicated gallon over 500 | Add 0.001 gallon per indicated gallon over 500 |

(Added 1989)

T.3. Repeatability. – When multiple tests are conducted at approximately the same flow rate and draft size, the range of the test results for the flow rate shall not exceed 40 % of the absolute value of the maintenance tolerance and the results of each test shall be within the applicable tolerance (Also see also N.4.1.1. Repeatability Tests).

(Added 2002)

UR. User Requirements

UR.1. Installation Requirements.

UR.1.1. Plumb and Level Condition. – A device installed in a fixed location shall be installed plumb and level, and the installation shall be sufficiently strong and rigid to maintain this condition.

UR.1.2. Discharge Rate. – A meter shall be so installed that the actual maximum discharge rate will not exceed the rated maximum discharge rate. If necessary, means for flow regulation shall be incorporated in the installation, in which case this shall be fully effective and automatic in operation.

UR.1.3. Unit Price. – There shall be displayed on the face of a device of the computing type the unit price at which the device is set to compute.

UR.1.4. Intake Hose. – The intake hose shall be so installed as to permit complete drainage and that all available product is measured following each transfer.

UR.2. Use Requirements.

UR.2.1. Return of Indicating and Recording Elements to Zero. – The primary indicating elements (visual), and the primary recording elements when these are returnable to zero, shall be returned to zero before each transfer.

UR.2.2. Printed Ticket. – Any printed ticket issued by a device of the computing type on which there is printed the total computed price, the total quantity, or the price per unit of quantity, shall also show the other two values (either printed or in clear script).

(Amended 1989)

UR.2.3. Ticket in Printing Device. – A ticket shall not be inserted into a device equipped with a ticket printer until immediately before a transfer is begun. If the meter is mounted on a vehicle, in no case shall a ticket be in the device when the vehicle is in motion while on a public street, highway, or thoroughfare.

UR.2.4. Credit for Flood Volume. – The volume of product necessary to flood the system as marked on the air eliminator shall be individually recorded on the ticket of each transfer affected.

THIS PAGE INTENTIONALLY LEFT BLANK

MARKUP COPY

Section 3.36. Water Meters

A. Application

A.1. General. – This code applies to devices used for the measurement of water; generally applicable to, but not limited to, utilities type meters installed in residences or business establishments and meters installed in batching systems.

(Amended 2002)

A.2. Exceptions. – This code does not apply to:

(a) water meters mounted on vehicle tanks (for which see Section 3.31. Vehicle-Tank Meters); or

(b) mass flow meters ~~(. (Also see Section 3.37. Mass Flow Meters).)~~
(Added 1994)

~~A.3. Additions of Section 1.10. General Code.~~ **A.3. Additional Code Requirements.** – In addition to the requirements of this code, Water Meters shall meet the ~~requirements~~ **requirements of Section 1.10. General Code.**

S. Specifications

S.1. Design of Indicating and Recording Elements and of Recorded Representations.

S.1.1. Primary Elements.

S.1.1.1. General. – A water meter shall be equipped with a primary indicating element and may also be equipped with a primary recording element. Such elements shall be visible at the point of measurement or be stored in non-volatile and nonresettable memory. The display may be remotely located provided it is readily accessible to the customer.

(Amended 2002)

S.1.1.2. Units. – A water meter shall indicate and record, if the device is equipped to record, its deliveries in terms of liters, gallons or cubic feet or binary or decimal subdivisions thereof except batch plant meters, which shall indicate deliveries in terms of liters, gallons or decimal subdivisions of the liter or gallon only.

S.1.1.3. Value of Smallest Unit. – The value of the smallest unit of indicated delivery and recorded delivery, if the device is equipped to record, shall not exceed the equivalent of:

(a) 50 L (10 gal or 1 ft³) on utility type meters, sizes 1 in and smaller; or

(b) 500 L (100 gal or 10 ft³) on utility-type meters, sizes 1½ in and 2 in; or

(c) 0.2 L (1/10 gal or 1/100 ft³) on batching meters delivering less than 375 L/min (100 gal/min or 13 ft³/min); or

(d) 5 L (1 gal or 1/10 ft³) on batching meters delivering 375 L/min (100 gal/min or 13 ft³/min) or more.

(Amended 2009)

S.1.1.4. Advancement of Indicating and Recording Elements. – Primary indicating and recording elements shall be susceptible to advancement only by the mechanical operation of the device.

S.1.1.5. Return to Zero. – If the meter is so designed that the primary indicating elements are readily returnable to a definite zero indication, means shall be provided to prevent the return of these elements beyond their correct zero position.

S.1.1.6. Proving indicator. – Utility-type meters shall be equipped with a proving indicator. The individual graduations on a mechanical (analog) proving indicator shall indicate volumes no larger than $1/100$ of the value of the smallest unit of indicated delivery required in S.1.1.3. Value of Smallest Unit. For electronic (digital) proving indications, the smallest unit of volume displayed shall be no larger than $1/1000$ of the value of the smallest unit of indicated delivery required in S.1.1.3.

(Added 2009)

S.1.2. Graduations.

S.1.2.1. Length. – Graduations shall be so varied in length that they may be conveniently read.

S.1.2.2. Width. – In any series of graduations, the width of a graduation shall in no case be greater than the width of the minimum clear interval between graduations, and the width of main graduations shall be not more than 50 % greater than the width of subordinate graduations. Graduations shall in no case be less than 0.2 mm (0.008 in) in width.

S.1.2.3. Clear Interval Between Graduations. – The clear interval shall not be less than 1.0 mm (0.04 in). If the graduations are not parallel, the measurement shall be made:

- (a) along the line of relative movement between the graduations at the end of the indicator; or
- (b) if the indicator is continuous, at the point of widest separation of the graduations.

S.1.3. Indicators.

S.1.3.1. Symmetry. – The index of an indicator shall be symmetrical with respect to the graduations, at least throughout that portion of its length associated with the graduations.

S.1.3.2. Length. – The index of an indicator shall reach to the finest graduations with which it is used, the width of the minimum clear interval between graduations, and the width of main graduations shall be not more than 50 % greater than the width of subordinate graduations. Graduations shall in no case be less than 0.2 mm (0.008 in) in width.

S.1.3.3. Width. – The width of the index of an indicator in relation to the series of graduations with which it is used shall not be greater than:

- (a) *the width of the narrowest graduation;** and
[*Nonretroactive as of January 1, 2002]

(Amended 2001)

- (b) the width of the minimum clear interval between graduations.

When the index of an indicator extends along the entire length of a graduation, that portion of the index of the indicator that may be brought into coincidence with the graduation shall be of the same width throughout the length of the index that coincides with the graduation.

S.1.3.4. Clearance. – The clearance between the index of an indicator and the graduations shall in no case be more than 1.5 mm (0.06 in).

S.1.3.5. Parallax. – Parallax effects shall be reduced to the practicable minimum.

S.2. Design of Measuring Elements.

S.2.1. Provision for Sealing. – Adequate provision shall be made for applying security seals in such a manner that no adjustment or interchange may be made of:

- (a) any measurement elements; and
- (b) any adjustable element for controlling delivery rate when such rate tends to affect the accuracy of deliveries.

The adjusting mechanism shall be readily accessible for purposes of affixing a security seal.

S.2.2. Batching Meters Only.

S.2.2.1. Air Elimination. – Batching meters shall be equipped with an effective air eliminator.

S.2.2.2. Directional Flow Valves. – Valves intended to prevent reversal of flow shall be automatic in operation.

S.2.3. Multi-Jet Meter Identification. – Multi-Jet water meters shall be clearly and permanently marked as such on the device or identified on the Certificate of Conformance.

(Added 2003)

S.3. Markings

S.3.1. Location of Marking Information; Utility Type Meters. – All required markings, including those required by G-S.1. Identification, shall be either on the meter body or primary indicator.
[Nonretroactive as of January 1, 2013]

(Added 2012)

N. Notes

N.1. Test Liquid. – A meter shall be tested with water.

N.2. Evaporation and Volume Change. – Care shall be exercised to reduce to a minimum, evaporation losses and volume changes resulting from changes to temperature of the test liquid.

N.3. Test Drafts. – Test drafts should be equal to at least the amount delivered by the device in two minutes and in no case less than the amount delivered by the device in one minute at the actual maximum flow rate developed by the installation. The test draft sizes shown in Table N.4.1. Flow Rate and Draft Size for Water Meters Normal Tests, shall be followed as closely as possible.

(Amended 2003)

N.4. Testing Procedures.

N.4.1. Normal Tests. – The normal test of a meter shall be made at the maximum discharge rate developed by the installation. Meters with maximum gallon per minute ratings higher than the values specified in Table N.4.1. Flow Rate and Draft Size for Water Meters Normal Tests may be tested up to the meter rating, with meter indications no less than those shown.

(Amended 1990, 2002, and 2003)

| Table N.4.1. Flow Rate and Draft Size for Water Meters Normal Tests | | | |
|--|---------------------------|-----------------------------|-----------------|
| Meter Size (inches) | Rate of Flow (gal/min) | Maximum Rate | |
| | | Meter Indication/Test Draft | |
| | | gal | ft ³ |
| Less than ⁵ / ₈ | 8 | 50 | 5 |
| ⁵ / ₈ | 15 | 50 | 5 |
| ³ / ₄ | 25 | 50 | 5 |
| 1 | 40 | 100 | 10 |
| 1½ | 80 | 300 | 40 |
| 2 | 120 | 500 | 40 |
| 3 | 250 | 500 | 50 |
| 4 | 350 | 1000 | 100 |
| 6 | 700 | 1000 | 100 |

(Table Added 2003)

N.4.1.1. Repeatability Tests. – Tests for repeatability should include a minimum of three consecutive test drafts of approximately the same size and be conducted under controlled conditions where variations in factors such as temperature, pressure, and flow rate are reduced to the extent that they will not affect the results obtained.

(Added 2002)

N.4.2. Special Tests. – Special tests to develop the operating characteristics of meters may be made according to the rates and quantities shown in Table N.4.2.a. Flow Rate and Draft Size for Water Meters Special Tests and Table N.4.2.b. Flow Rate and Draft Size for Utility Type Water Meters Special Tests.

(Amended 2003 and 2010)

| Table N.4.2.a. Flow Rate and Draft Size for Batching Water Meters Special Tests | | | | | | |
|--|---------------------------|-----------------------------|-----------------|-----------------------------|-----------------------------|-----------------|
| Meter Size (inches) | Intermediate Rate | | | Minimum Rate | | |
| | Rate of Flow (gal/min) | Meter Indication/Test Draft | | Rate of Flow (gal/min) | Meter Indication/Test Draft | |
| | | gal | ft ³ | | gal | ft ³ |
| Less than or equal to ⁵ / ₈ | 2 | 10 | 1 | ¹ / ₄ | 5 | 1 |
| ³ / ₄ | 3 | 10 | 1 | ¹ / ₂ | 5 | 1 |
| 1 | 4 | 10 | 1 | ³ / ₄ | 5 | 1 |
| 1½ | 8 | 50 | 5 | 1½ | 10 | 1 |
| 2 | 15 | 50 | 5 | 2 | 10 | 1 |
| 3 | 20 | 50 | 5 | 4 | 10 | 1 |
| 4 | 40 | 100 | 10 | 7 | 50 | 5 |
| 6 | 60 | 100 | 10 | 12 | 50 | 5 |

(Table Added 2003) (Table Amended 2010)

| Table N.4.2.b. Flow Rate and Draft Size for Utility Type Water Meters Special Tests | | | | | | |
|--|---------------------------|-----------------------------|-----------------|---------------------------|-----------------------------|-----------------|
| Meter Size (inches) | Intermediate Rate | | | Minimum Rate | | |
| | Rate of Flow (gal/min) | Meter Indication/Test Draft | | Rate of Flow (gal/min) | Meter Indication/Test Draft | |
| | | gal | ft ³ | | gal | ft ³ |
| Less than $\frac{5}{8}$ | 2 | 10 | 1 | $\frac{1}{4}$ | 5 | 1 |
| $\frac{5}{8}$ | 2 | 10 | 1 | $\frac{1}{4}$ | 5 | 1 |
| $\frac{5}{8} \times \frac{3}{4}$ | 2 | 10 | 1 | $\frac{1}{4}$ | 5 | 1 |
| $\frac{3}{4}$ | 3 | 10 | 1 | $\frac{1}{2}$ | 5 | 1 |
| 1 | 4 | 10 | 1 | $\frac{3}{4}$ | 5 | 1 |
| $1\frac{1}{2}$ | 8 | 100 | 10 | $1\frac{1}{2}$ | 100 | 10 |
| 2 | 15 | 100 | 10 | 2 | 100 | 10 |

(Table Added 2010)

N.4.3. Batching Meter Tests. – Tests on batching meters should be conducted at the maximum and intermediate rates only.

T. Tolerances

T.1. Tolerance Values. – Maintenance and acceptance tolerances shall be as shown in Table T.1. Accuracy Classes and Tolerances for Water Meters.

(Amended 2003)

| Table T.1. Accuracy Classes and Tolerances for Water Meters | | | | | |
|--|--|-------------------|----------------------|-----------------------|--|
| Accuracy Class | Application | | Acceptance Tolerance | Maintenance Tolerance | Tolerance for Special Tests Conducted at the Minimum Flow Rate |
| 1.5 | Water, Other Than Multi-Jet Water Meters | Overregistration | 1.5 % | 1.5 % | 1.5 % |
| | | Underregistration | 1.5 % | 1.5 % | 5.0 % |
| 1.5 | Water, Multi-Jet Water Meters | Overregistration | 1.5 % | 1.5 % | 3.0 % |
| | | Underregistration | 1.5 % | 1.5 % | 3.0 % |

(Table Added 2003)

T.1.1. Repeatability. – When multiple tests are conducted at approximately the same flow rate, each test shall be within the applicable tolerances and the range of test results shall not exceed the values shown in Table T.1.1. Repeatability.

(Added 2002) (Amended 2010)

| Table T.1.1. Repeatability | | |
|---------------------------------------|------------------------|----------------------------|
| | Batching Meters | Utility-Type Meters |
| Normal Flow Rates | 0.6 % | 0.6 % |
| Intermediate Flow Rates | 0.6 % | 2.0 % |
| Minimum Flow Rate | 1.3 % | 4.0 % |

(Table Added 2010)

UR. User Requirements

UR.1. Batching Meters Only.

UR.1.1. Strainer. – A filter or strainer shall be provided if it is determined that the water contains excessive amounts of foreign material.

UR.1.2. Siphon Breaker. – An automatic siphon breaker or other effective means shall be installed in the discharge piping at the highest point of outlet, in no case below the top of the meter, to prevent siphoning of the meter and permit rapid drainage of the pipe or hose.

UR.1.3. Provision for Testing. – Acceptable provisions for testing shall be incorporated into all meter systems. Such provisions shall include a two-way valve, or manifold valving, and a pipe or hose installed in the discharge line accessible to the proper positioning of the test measure.

UR.2. Accessibility of Customer Indication. – An unobstructed standing space of at least 76 cm (30 in) wide, 91 cm (36 in) deep, and 198 cm (78 in) high shall be maintained in front of an indication intended for use by the customer to allow for reading the indicator. The customer indication shall be readily observable to a person located within the standing space without necessity of a separate tool or device.

(Added 2008)

Section 3.37. Mass Flow Meters

A. Application

A.1. Liquids. – This code applies to devices that are designed to dynamically measure the mass, or the mass and density of liquids. It also specifies the relevant examinations and tests that are to be conducted.

(Amended 1997)

A.2. Vapor (Gases). – This code applies to devices that are designed to dynamically measure the mass of hydrocarbon gas in the vapor state. Examples of these products are propane, propylene, butanes, butylenes, ethane, methane, natural gas and any other hydrocarbon gas/air mix.

A.3. Additional Code Requirements. – In addition to the requirements of this code, Mass Flow Meters shall meet the requirements of Section 1.10. General Code.

S. Specifications

S.1. Indicating and Recording Elements.

S.1.1. Indicating Elements. – A measuring assembly shall include an indicating element. Indications shall be clear, definite, accurate, and easily read under normal conditions of operation of the instrument.

S.1.2. Natural Gas Dispensers. – Except for fleet sales and other price contract sales, a natural gas dispenser used to refuel vehicles shall be of the computing type and shall indicate the quantity, the unit price, and the total price of each delivery. The dispenser shall display the mass measured for each transaction either continuously on an external or internal display accessible during the inspection and test of the dispenser, or display the quantity in mass units by using controls on the device.

(Added 1994)(Amended 2013)

S.1.3. Units.

S.1.3.1. Units of Measurement. – Deliveries shall be indicated and recorded in grams, kilograms, metric tons, pounds, tons, and/or liters, gallons, quarts, pints and decimal subdivisions thereof. The indication of a delivery shall be on the basis of apparent mass versus a density of 8.0 g/cm³. The volume indication shall be based on the mass measurement and an automatic means to determine and correct for changes in product density.

(Amended 1993 and 1997)

S.1.3.1.1. Natural Gas Used as an Engine Fuel. – When natural gas is dispensed as an engine fuel, the delivered quantity shall be indicated.

(a) “gasoline liter equivalent (GLE) units” or gasoline gallon equivalent (GGE) units,

(b) “diesel liter equivalent (DLE) units” or “diesel gallon equivalent (DGE) units: (see definitions).

(Added 1994) (Amended 2013)

S.1.3.2. Numerical Value of Quantity-Value Divisions. – The value of a scale interval shall be equal to:

(a) 1, 2, or 5; or

(b) a decimal multiple or submultiple of 1, 2, or 5.

S.1.3.3. Maximum Value of Quantity-Value Divisions.

- (a) The maximum value of the quantity-value division for liquids shall not be greater than 0.2 % of the minimum measured quantity.
- (b) For dispensers of compressed natural gas used to refuel vehicles, the value of the division for the gasoline liter equivalent shall not exceed 0.01 GLE; the division for gasoline gallon equivalent (GGE) shall not exceed 0.001 GGE. The maximum value of the mass division shall not exceed 0.001 kg or 0.001 lb.

(Amended 1994)

S.1.3.4. Values Defined. – Indicated values shall be adequately defined by a sufficient number of figures, words, symbols, or combinations thereof. A display of “zero” shall be a zero digit for all displayed digits to the right of the decimal mark and at least one to the left.

S.2. Operating Requirements.

S.2.1. Return to Zero. – Except for measuring assemblies in a pipeline:

- (a) One indicator and the primary recording elements, if the device is equipped to record, shall be provided with a means for readily returning the indication to zero either automatically or manually.
- (b) It shall not be possible to return primary indicating elements, or primary recording elements, beyond the correct zero position.

(Amended 1993)

S.2.2. Indicator Reset Mechanism. – The reset mechanism for the indicating element shall not be operable during a delivery. Once the zeroing operation has begun, it shall not be possible to indicate a value other than the latest measurement, or “zeros” when the zeroing operation has been completed.

S.2.3. Nonresettable Indicator. – An instrument may also be equipped with a nonresettable indicator if the indicated values cannot be construed to be the indicated values of the resettable indicator for a delivered quantity.

S.2.4. Provisions for Power Loss.

S.2.4.1. Transaction Information. – In the event of a power loss, the information needed to complete any transaction in progress at the time of the power loss (such as the quantity and unit price, or sales price) shall be determinable for at least 15 minutes at the dispenser or at the console if the console is accessible to the customer.

(Added 1993)

S.2.4.2. User Information. – The device memory shall retain information on the quantity of fuel dispensed and the sales price totals during power loss.

(Added 1993)

S.2.5. Display of Unit Price and Product Identity.

S.2.5.1. Unit Price. – A computing or money-operated device shall be able to display on each face the unit price at which the device is set to compute or to dispense.

(Added 1993)

S.2.5.2. Product Identity. – A device shall be able to conspicuously display on each side the identity of the product being dispensed.

(Added 1993)

S.2.5.3. Selection of Unit Price. – *Except for dispensers used exclusively for fleet sales, other price contract sales, and truck refueling (e.g., truck stop dispensers used only to refuel trucks), when a product or grade is offered for sale at more than one unit price through a computing device, the selection of the unit price shall be made prior to delivery using controls on the device or other customer-activated controls. A system shall not permit a change to the unit price during delivery of a product.*

[Nonretroactive as of January 1, 1998]

(Added 1997)

S.2.5.4. Agreement Between Indications. – *When a quantity value indicated or recorded by an auxiliary element is a derived or computed value based on data received from a retail motor-fuel dispenser, the value may differ from the quantity value displayed on the dispenser, provided the following conditions are met:*

(a) *all total money-values for an individual sale that are indicated or recorded by the system agree; and*

(b) *within each element the values indicated or recorded meet the formula (quantity x unit price = total sales price) to the closest cent.*

[Nonretroactive as of January 1, 1998]

(Added 1997)

S.2.6. Money-Value Computations. – A computing device shall compute the total sales price at any single-purchase unit price (i.e., excluding fleet sales, other price contract sales, and truck stop dispensers used only to refuel trucks) for which the product being measured is offered for sale at any delivery possible within either the measurement range of the device or the range of the computing elements, whichever is less.

(Added 1993)

S.2.6.1. Auxiliary Elements. – If a system is equipped with auxiliary indications, all indicated money-value and quantity divisions of the auxiliary element shall be identical with those of the primary element.

(Added 1993)

S.2.6.2. Display of Quantity and Total Price. – When a delivery is completed, the total price and quantity for that transaction shall be displayed on the face of the dispenser for at least 5 minutes or until the next transaction is initiated by using controls on the device or other user-activated controls.

(Added 1993)

S.2.7. Recorded Representations, Point-of-Sale Systems. – *The sales information recorded by cash registers when interfaced with a retail motor-fuel dispenser shall contain the following information for products delivered by the dispenser:*

(a) *the total volume of the delivery;*

(b) *the unit price;*

(c) *the total computed price; and*

(d) *the product identity by name, symbol, abbreviation, or code number.*

[Nonretroactive as of January 1, 1986]

(Added 1993)

S.2.8. Indication of Delivery. – *The device shall automatically show on its face the initial zero condition and the quantity delivered (up to the nominal capacity). However, the first 0.03 L (0.009 gal) of a delivery and its associated total sales price need not be indicated.*

[Nonretroactive as of January 1, 1998]

(Added 1997)

S.3. Measuring Elements and Measuring Systems.

S.3.1. Maximum and Minimum Flow-Rates.

- (a) The ratio of the maximum to minimum flow-rates specified by the manufacturer for devices measuring liquefied gases shall be 5:1 or greater.
- (b) The ratio of the maximum to minimum flow-rates specified by the manufacturer for devices measuring other than liquefied gases shall be 10:1 or greater.

S.3.2. Adjustment Means. – An assembly shall be provided with the means to change the ratio between the indicated quantity and the quantity of liquid measured by the assembly. A bypass on the measuring assembly shall not be used for these means.

S.3.2.1. Discontinuous Adjusting Means. – When the adjusting means changes the ratio between the indicated quantity and the quantity of measured liquid in a discontinuous manner, the consecutive values of the ratio shall not differ by more than 0.1 %.

S.3.3. Vapor Elimination. – A liquid-measuring instrument or measuring system shall be equipped with an effective vapor or air eliminator or other effective means, automatic in operation, to prevent the measurement of vapor and air. Vent lines from the air or vapor eliminator shall be made of metal tubing or some other suitable rigid material.

(Amended 1999)

S.3.3.1. Vapor Elimination on Loading Rack Liquid Metering Systems.

- (a) A loading rack liquid metering system shall be equipped with a vapor or air eliminator or other automatic means to prevent the passage of vapor and air through the meter unless the system is designed or operationally controlled by a method, approved by the weights and measures jurisdiction having statutory authority over the device, such that neither air nor vapor can enter the system.
- (b) Vent lines from the air or vapor eliminator (if present) shall be made of metal tubing or other rigid material.

(Added 1995)

S.3.4. Maintenance of Liquid State. – A liquid-measuring device shall be installed so that the measured product remains in a liquid state during passage through the instrument.

S.3.5. Provision for Sealing. – Adequate provision shall be made for an approved means of security (e.g., data change audit trail) or physically applying security seals in such a manner that no adjustment or interchange may be made of:

- (a) any measuring or indicating element;
- (b) any adjustable element for controlling delivery rate when such rate tends to affect the accuracy of deliveries;

- (c) the zero adjustment mechanism; and
- (d) any metrological parameter that will affect the metrological integrity of the device or system.

When applicable, the adjusting mechanism shall be readily accessible for purposes of affixing a security seal.

*[Audit trails shall use the format set forth in Table S.3.5. Categories of Device and Methods of Sealing]**

*[*Nonretroactive as of January 1, 1995]*

(Amended 1992, 1995, and 2006)

| Table S.3.5. Categories of Device and Methods of Sealing | |
|---|--|
| Categories of Device | Methods of Sealing |
| <p>Category 1: <i>No remote configuration capability.</i></p> | <p><i>Seal by physical seal or two event counters: one for calibration parameters and one for configuration parameters.</i></p> |
| <p>Category 2: <i>Remote configuration capability, but access is controlled by physical hardware.</i></p> <p><i>The device shall clearly indicate that it is in the remote configuration mode and record such message if capable of printing in this mode or shall not operate while in this mode.</i></p> | <p><i>[The hardware enabling access for remote communication must be on-site. The hardware must be sealed using a physical seal or an event counter for calibration parameters and an event counter for configuration parameters. The event counters may be located either at the individual measuring device or at the system controller; however, an adequate number of counters must be provided to monitor the calibration and configuration parameters of the individual devices at a location. If the counters are located in the system controller rather than at the individual device, means must be provided to generate a hard copy of the information through an on-site device.]*</i></p> <p><i>[*Nonretroactive as of January 1, 1996]</i></p> |
| <p>Category 3: <i>Remote configuration capability access may be unlimited or controlled through a software switch (e.g., password).</i></p> <p><i>[Nonretroactive as of January 1, 1995]</i></p> <p><i>The device shall clearly indicate that it is in the remote configuration mode and record such message if capable of printing in this mode or shall not operate while in this mode.</i></p> <p><i>[Nonretroactive as of January 1, 2001]</i></p> | <p><i>An event logger is required in the device; it must include an event counter (000 to 999), the parameter ID, the date and time of the change, and the new value of the parameter. A printed copy of the information must be available through the device or through another on-site device. The event logger shall have a capacity to retain records equal to 10 times the number of sealable parameters in the device, but not more than 1000 records are required. (Note: Does not require 1000 changes to be stored for each parameter.)</i></p> |

[Nonretroactive as of January 1, 1995]

(Table Added 1995) (Amended 1995, 1998, 1999, and 2006)

S.3.6. Automatic Density Correction.

- (a) An automatic means to determine and correct for changes in product density shall be incorporated in any mass flow metering system that is affected by changes in the density of the product being measured.
- (b) Volume-measuring devices with automatic temperature compensation used to measure natural gas as a motor vehicle engine fuel shall be equipped with an automatic means to determine

and correct for changes in product density due to changes in the temperature, pressure, and composition of the product.

(Amended 1994 and 1997)

S.3.7. Pressurizing the Discharge Hose. – The discharge hose for compressed natural gas shall automatically pressurize prior to the device beginning to register the delivery.

(Added 1993)

S.3.8. Zero-Set-Back Interlock, Retail Motor-Fuel Devices. – A device shall be constructed so that:

- (a) after a delivery cycle has been completed by moving the starting lever to any position that shuts off the device, an automatic interlock prevents a subsequent delivery until the indicating elements, and recording elements if the device is equipped and activated to record, have been returned to their zero positions;
- (b) the discharge nozzle cannot be returned to its designed hanging position (that is, any position where the tip of the nozzle is placed in its designed receptacle and the lock can be inserted) until the starting lever is in its designed shut-off position and the zero-set-back interlock has been engaged; and
- (c) in a system with more than one dispenser supplied by a single pump, an effective automatic control valve in each dispenser prevents product from being delivered until the indicating elements on that dispenser are in a correct zero position.

(Added 1993)

S.4. Discharge Lines and Valves.

S.4.1. Diversion of Measured Product. – No means shall be provided by which any measured product can be diverted from the measuring instrument. However, two or more delivery outlets may be permanently installed and operated simultaneously, provided that any diversion of flow to other than the intended receiving receptacle cannot be readily accomplished or is readily apparent. Such means include physical barriers, visible valves, or indications that make it clear which outlets are in operation, and explanatory signs if deemed necessary.

An outlet that may be opened for purging or draining the measuring system, or for recirculating product if recirculation is required in order to maintain the product in a deliverable state shall be permitted. Effective automatic means shall be provided to prevent the passage of liquid through any such outlet during normal operation of the measuring system and to inhibit meter indications (or advancement of indications) and recorded representations while the outlet is in operation.

(Amended 2002 and 2006)

S.4.2. Pump-Discharge Unit. – A pump-discharge unit for liquids equipped with a flexible discharge hose shall be of the wet-hose type.

(Added 1993)

S.4.3. Directional Flow Valves. – If a reversal of flow could result in errors that exceed the tolerance for the minimum measured quantity, a valve or valves or other effective means, automatic in operation (and equipped with a pressure limiting device, if necessary) to prevent the reversal of flow shall be properly installed in the system. (~~See Also see~~ N.1. Minimum Measured Quantity.)

S.4.4. Discharge Valves. – A discharge valve may be installed on a discharge line only if the system is a wet-hose type. Any other shutoff valve on the discharge side of the instrument shall be of the automatic or semiautomatic predetermined-stop type or shall be operable only:

- (a) by means of a tool (but not a pin) entirely separate from the device; or
- (b) by means of a security seal with which the valve is sealed open.

S.4.5. Antidrain Means. – In a wet-hose type device, effective means shall be provided to prevent the drainage of the hose between transactions.

S.4.6. Other Valves. – Check valves and closing mechanisms that are not used to define the measured quantity shall have relief valves (if necessary) to dissipate any abnormally high pressure that may arise in the measuring assembly.

S.5. Markings. – A measuring system shall be legibly and indelibly marked with the following information:

- (a) pattern approval mark (i.e., type approval number);
- (b) name and address of the manufacturer or his trademark and, if required by the weights and measures authority, the manufacturer's identification mark in addition to the trademark;
- (c) model identifier or product name selected by the manufacturer;
- (d) nonrepetitive serial number;
- (e) *the accuracy class of the meter as specified by the manufacturer consistent with Table T.2. Accuracy Classes for Mass Flow Meter Applications Covered in NIST Handbook 44, Section 3.37 Mass Flow Meters;**
[*Nonretroactive as of January 1, 1995]
(Added 1994)
- (f) maximum and minimum flow rates in pounds per unit of time;
- (g) maximum working pressure;
- (h) applicable range of temperature if other than $-10\text{ }^{\circ}\text{C}$ to $+50\text{ }^{\circ}\text{C}$;
- (i) minimum measured quantity; and
- (j) product limitations, if applicable.

S.5.1. Location of Marking Information; Retail Motor-Fuel Dispensers. – *The marking information required in General Code, paragraph G-S.1. Identification shall appear as follows:*

- (a) *within 60 cm (24 in) to 150 cm (60 in) from the base of the dispenser;*
- (b) *either internally and/or externally provided the information is permanent and easily read; and*
- (c) *on a portion of the device that cannot be readily removed or interchanged (i.e., not on a service access panel).*

Note: *The use of a dispenser key or tool to access internal marking information is permitted for retail liquid-measuring devices.*

[Nonretroactive as of January 1, 2003]

(Added 2006)

S.5.2. Marking of Diesel and Gasoline Volume Equivalent Conversion Factor. – A device dispensing natural gas shall have

- (a) either the statement “1 Gasoline Liter Equivalent (GLE) is Equal to 0.678 kg of Natural Gas” or “1 Gasoline Gallon Equivalent (GGE) is Equal to 5.660 lb of natural Gas”,
- (b) either ther statement “1 Diesel Liter Equivalent (DLE) is Equal to 0.756 kg of Natural Gas” or “1 Diesel Gallon Equivalent (DGE) is Equal to 6.22 lb of Natural Gas”

permanently and conspicuously marked on the face of the dispenser according to the method of sale used.

(Added 1994)(Amended 2013)

S.6. Printer. – When an assembly is equipped with means for printing the measured quantity, the following conditions apply:

- (a) the scale interval shall be the same as that of the indicator;
- (b) the value of the printed quantity shall be the same value as the indicated quantity;
- (c) a quantity for a delivery (other than an initial reference value) cannot be recorded until the measurement and delivery has been completed;
- (d) the printer is returned to zero when the resettable indicator is returned to zero; and
- (e) the printed values shall meet the requirements applicable to the indicated values.

S.6.1. Printed Receipt. – Any delivered, printed quantity shall include an identification number, the time and date, and the name of the seller. This information may be printed by the device or pre-printed on the ticket.

S.7. Totalizers for Retail Motor-Fuel Devices. – *Retail motor-fuel dispensers shall be equipped with a nonresettable totalizer for the quantity delivered through the metering device.*

[Nonretroactive as of January 1, 1998]

(Added 1997)

N. Notes

N.1. Minimum Measured Quantity. – The minimum measured quantity shall be specified by the manufacturer.

N.2. Test Medium.

N.2.1. Liquid-Measuring Devices. – The device shall be tested with the liquid that the device is intended to measure or another liquid with the same general physical characteristics.

N.2.2. Vapor-Measuring Devices. – The device shall be tested with air or the product to be measured.

N.3. Test Drafts. – The minimum test shall be one test draft at the maximum flow rate of the installation and one test draft at the minimum flow rate. More tests may be performed at these or other flow rates. (See Also see T.3. Repeatability.)

N.4. Minimum Measured Quantity. – The device shall be tested for a delivery equal to the declared minimum measured quantity when the device is likely to be used to make deliveries on the order of the minimum measured quantity.

N.5. Motor-Fuel Dispenser. – When a device is intended for use as a liquid motor-fuel dispenser, the type evaluation test shall include a test for accuracy using five starts and stops during a delivery to simulate the operation of the automatic shut-off nozzle. This test may be conducted as part of the normal inspection and test of the meter.

N.6. Testing Procedures.

N.6.1. Normal Tests. – The normal test of a meter shall be made at the maximum discharge rate developed by the installation. Any additional tests conducted at flow rates down to and including the rated minimum discharge flow rate shall be considered normal tests.

(Added 1999)

N.6.1.1. Repeatability Tests. – Tests for repeatability should include a minimum of three consecutive test drafts of approximately the same size and be conducted under controlled conditions where variations in factors such as temperature, pressure, and flow rate are reduced to the extent that they will not affect the results obtained.

(Added 2001)

N.6.2. Special Tests. – “Special” tests shall be made to develop the operating characteristics of a device and any special elements and accessories attached to or associated with the device. Any test except as set forth in N.6.1. Normal Tests shall be considered a special test. Special tests of a measuring system shall be made to develop operating characteristics of the measuring systems during a split compartment delivery. (See Also see Table T.2. Accuracy Classes and Tolerances for Mass Flow Meters.)

(Added 1999)

T. Tolerances

T.1. Tolerances, General.

- (a) The tolerances apply equally to errors of underregistration and errors of overregistration.
- (b) The tolerances apply to all products at all temperatures measured at any flow rate within the rated measuring range of the meter.

(Amended 1999)

T.2. Tolerances. – The tolerances for mass flow meters for specific liquids, gases, and applications are listed in Table T.2. Accuracy Classes and Tolerances for Mass Flow Meters.

(Amended 1994 and 1999)

| Accuracy Class | Application or Commodity Being Measured | Acceptance Tolerance | Maintenance Tolerance | Special Tolerance |
|----------------|--|----------------------|-----------------------|-------------------|
| 0.3 | - Large capacity motor-fuel dispensers (maximum discharge flow rates greater than 100 L/min or 25 gal/min) - Heated products (other than asphalt) at temperatures greater than 50 °C (122 °F) - Asphalt at temperatures equal to or below a temperature of 50 °C (122 °F) - Loading rack meters - Vehicle-tank meters - Home heating oil - Asphalt at or below 50 °C - Milk and other food products - All other liquid applications not shown in the table where the minimum delivery is at least 700 kg (1500 lb) | 0.2 % | 0.3 % | 0.5 % |
| 0.3A | - Asphalt at temperatures greater than 50 °C (122 °F) | 0.3 % | 0.3 % | 0.5 % |
| 0.5 | - Small capacity (retail) motor-fuel dispensers - Agri-chemical liquids - All other liquid applications not shown in the table where the minimum delivery is less than 700 kg or 1500 lb | 0.3 % | 0.5 % | 0.5 % |
| 1.0 | - Anhydrous ammonia - LP Gas (including vehicle-tank meters) | 0.6 % | 1.0 % | 1.0 % |
| 2.0 | - Compressed natural gas as a motor-fuel | 1.5 % | 2.0 % | 2.0 % |
| 2.5 | - Cryogenic liquid meters - Liquefied compressed gases other than LP Gas | 1.5 % | 2.5 % | 2.5 % |

(Added 1994) (Amended 1999, **2001**, and ~~2001~~**2013**)

T.3. Repeatability. – When multiple tests are conducted at approximately the same flow rate and draft size, the range of the test results for the flow rate shall not exceed 40 % of the absolute value of the maintenance tolerance and the results of each test shall be within the applicable tolerance. (~~See also~~ **Also see** N.6.1.1. Repeatability Tests.)
(Amended 1992, 1994, and 2001)

T.4. Type Evaluation Examinations for Liquid-Measuring Devices. – For type evaluation examinations, the tolerance values shall apply under the following conditions:

- (a) with any one liquid within the range of liquids;
- (b) at any one liquid temperature and pressure within the operating range of the meter; and
- (c) at all flow rates within the range of flow rates.

(Added 1993) (Amended 1994)

UR. User Requirements

UR.1. Selection Requirements.

UR.1.1. Discharge Hose-Length. – *The length of the discharge hose on a retail motor-fuel device shall not exceed 4.6 m (15 ft) unless it can be demonstrated that a longer hose is essential to permit deliveries to be made to receiving vehicles or vessels.*

[Nonretroactive as of January 1, 1998]

(Added 1997)

UR.1.2. Minimum Measured Quantity.

- (a) The minimum measured quantity shall be specified by the manufacturer.
- (b) The minimum measured quantity appropriate for a transaction may be specified by the weights and measures authority. A device may have a minimum measured quantity smaller than that specified by the weights and measures authority; however, the device must perform within the performance requirements for the declared minimum measured quantity.

UR.2. Installation Requirements.

UR.2.1. Manufacturer's Instructions. – A device shall be installed in accordance with the manufacturer's instructions, and the installation shall be sufficiently secure and rigid to maintain this condition.

(Added 1997)

UR.2.2. Discharge Rate. – A device shall be installed so that the actual maximum discharge rate will not exceed the rated maximum discharge rate. Automatic means of flow regulation shall be incorporated in the installation if necessary.

(Added 1997)

UR.2.3. Low-Flow Cut-Off Valve. – If a metering system is equipped with a programmable or adjustable "low-flow cut-off" feature:

- (a) the low-flow cut-off value shall not be set at flow rates lower than the minimum operating flow rate specified by the manufacturer on the meter; and
- (b) the system shall be equipped with flow control valves which prevent the flow of product and stop the indicator from registering product flow whenever the product flow rate is less than the low-flow cut-off value.

(Added 1992)

UR.3. Use of Device.

UR.3.1. Unit Price and Product Identity for Retail Dispensers. – The following information shall be conspicuously displayed or posted on the face of a retail dispenser used in direct sale:

- (a) except for dispensers used exclusively for fleet sales, other price contract sales, and truck refueling (e.g., truck stop dispensers used only to refuel trucks), all of the unit prices at which the product is offered for sale; and
- (b) in the case of a computing type or money-operated type, the unit price at which the dispenser is set to compute.

(Added 1993)

UR.3.2. Vapor-Return Line. – During any metered delivery of liquefied petroleum gas and other liquids from a supplier's tank to a receiving container, there shall be no vapor-return line from the receiving container to the supplier's tank:

- (a) in the case of any receiving container to which normal deliveries can be made without the use of such vapor-return line; or
- (b) in the case of any new receiving container when the ambient temperature is below 90 °F.

(Added 1993)

UR.3.3. Ticket Printer; Customer Ticket. – Vehicle-mounted metering systems shall be equipped with a ticket printer which shall be used for all sales where product is delivered through the meter. A copy of the ticket issued by the device shall be left with the customer at the time of delivery or as otherwise specified by the customer.

(Added 1994)

UR.3.4. Printed Ticket. – The total price, the total quantity of the delivery, and the price per unit shall be printed on any ticket issued by a device of the computing type and containing any one of these values.

(Added 1993)

UR.3.5. Ticket in Printing Device. – A ticket shall not be inserted into a device equipped with a ticket printer until immediately before a delivery is begun, and in no case shall a ticket be in the device when the vehicle is in motion while on a public street, highway, or thoroughfare.

(Added 1993)

UR.3.6. Steps After Dispensing. – After delivery to a customer from a retail motor-fuel device:

- (a) the starting lever shall be returned to its shutoff position and the zero-set-back interlock engaged; and
- (b) the discharge nozzle shall be returned to its designed hanging position unless the primary indicating elements, and recording elements, if the device is equipped and activated to record, have been returned to a definite zero indication.

(Added 1993)

UR.3.7. Return of Indicating and Recording Elements to Zero. – The primary indicating elements (visual), and the primary recording elements when these are returnable to zero, shall be returned to zero immediately before each delivery. Exceptions to this requirement are totalizers on key-lock-operated or other self-operated dispensers and the primary recording element if the device is equipped to record.

(Added 1995) (Amended 1997)

UR.3.8. Return of Product to Storage, Retail Compressed Natural Gas Dispensers. – Provisions at the site shall be made for returning product to storage or disposing of the product in a safe and timely manner during or following testing operations. Such provisions may include return lines, or cylinders adequate in size and number to permit this procedure.

(Added 1998)

Section 3.38. Carbon Dioxide Liquid-Measuring Devices

A. Application

- A.1. General.** – This code applies to liquid-measuring devices used for the measurement of liquid carbon dioxide.
- A.2. Exceptions.** – This code does not apply to devices used solely for dispensing a product in connection with operations in which the amount dispensed does not affect customer charges.
- A.3. Additional Code Requirements.** – In addition to the requirements of this code, Carbon Dioxide Liquid-Measuring Devices shall meet the requirements of Section 1.10. General Code.
- A.4. Type Evaluation.** – The National Type Evaluation Program will accept for type evaluation only those devices that comply with all requirements of this code.
- (Added 1998)

S. Specifications

S.1. Design of Indicating and Recording Elements and of Recorded Representations.

S.1.1. Primary Elements.

S.1.1.1. General. – A device shall be equipped with a primary indicating element and may also be equipped with a primary recording element.

S.1.1.2. Units. – A device shall indicate and record, if equipped to record, its deliveries in terms of pounds or kilograms or decimal subdivisions or multiples thereof.

S.1.1.3. Value of Smallest Unit. – The value of the smallest unit of indicated delivery, and recorded delivery, if the device is equipped to record, shall not exceed the equivalent of:

(a) for small delivery devices:

(1) 1 kilogram; or

(2) 1 pound

(b) for large delivery devices:

(1) 10 kilograms; or

(2) 10 pounds

S.1.1.4. Advancement of Indicating and Recording Elements. – Primary indicating and recording elements shall be susceptible to advancement only by the normal operation of the device. However, a device may be cleared by advancing its elements to zero, but only if:

(a) the advancing movement, once started, cannot be stopped until zero is reached; or

(b) in the case of indicating elements only, such elements are automatically obscured until the elements reach the correct zero position.

S.1.1.5. Return to Zero. – Primary indicating and recording elements shall be readily returnable to a definite zero indication. Means shall be provided to prevent the return of primary indicating elements and of primary recording elements beyond their correct zero position.

S.1.2. Graduations.

S.1.2.1. Length. – Graduations shall be so varied in length that they may be conveniently read.

S.1.2.2. Width. – In any series of graduations, the width of a graduation shall in no case be greater than the width of the minimum clear interval between graduations. The width of main graduations shall be not more than 50 % greater than the width of subordinate graduations. Graduations shall in no case be less than 0.2 mm (0.008 in) in width.

S.1.2.3. Clear Interval Between Graduations. – The clear interval shall be not less than 1.0 mm (0.04 in). If the graduations are not parallel, the measurement shall be made:

- (a) along the line of relative movement between the graduations at the end of the indicator; or
 - (b) if the indicator is continuous, at the point of widest separation of the graduations.
- (See Also see also S.1.3.6. Travel of Indicator.)

S.1.3. Indicators.

S.1.3.1. Symmetry. – The index of an indicator shall be of the same shape as the graduations at least throughout that portion of its length associated with the graduations.

S.1.3.2. Length. – The index of an indicator shall reach to the finest graduations with which it is used, unless the indicator and the graduations are in the same plane, in which case the distance between the end of the indicator and the ends of the graduations, measured along the line of the graduations, shall be not more than 1.0 mm (0.04 in).

S.1.3.3. Width. – The width of the index of the indicator in relation to the series of graduations with which it is used shall be not greater than:

- (a) *the width of the narrowest graduation;** and
[*Nonretroactive as of January 1, 2002]
(Amended 2001)
- (b) the width of the minimum clear interval between graduations.

When the index of an indicator extends along the entire length of a graduation, that portion of the index of the indicator that may be brought into coincidence with the graduation shall be of the same width throughout the length of the index that coincides with the graduation.

S.1.3.4. Clearance. – The clearance between the index of an indicator and the graduations shall in no case be more than 1.5 mm (0.06 in).

S.1.3.5. Parallax. – Parallax effects shall be reduced to the practicable minimum.

S.1.3.6. Travel of Indicator. – If the most sensitive element of the primary indicating element utilizes an indicator and graduations, the relative movement of these parts corresponding to the smallest indicated value shall be no less than 5 mm (0.20 in).

S.1.4. Computing-Type Devices.

S.1.4.1. Printed Ticket. – Any printed ticket issued by a device of the computing type on which there is printed the total computed price shall have printed clearly thereon also the total quantity of the delivery and the price per unit.

S.1.4.2. Money-Value Computations. – Money-value computations shall be of the full-computing type in which the money-value at a single unit price, or at each of a series of unit prices, shall be computed for every delivery within either the range of measurement of the device or the range of the computing elements, whichever is less.

The total price shall be computed on the basis of the quantity indicated when the value of the smallest division indicated is equal to or less than the value specified in S.1.1.3. Value of Smallest Unit.

S.1.4.3. Money-Values, Mathematical Agreement. – Any digital money-value indication and any recorded money-value on a computing-type device shall be in mathematical agreement with its associated quantity indication or representation to within 1 cent of money-value.

S.2. Design of Measuring Elements.

S.2.1. Vapor Elimination. – A measuring system shall be equipped with an effective vapor eliminator or other effective means to prevent the measurement of vapor that will cause errors in excess of the applicable tolerances.

S.2.2. Reverse Flow Measurement. – Effective means, automatic in operation, shall be installed to prevent reverse flow measurement.

S.2.3. Maintenance of Liquid State. – A device shall be so designed that the product being measured will remain in a liquid state during passage through the device.

S.2.4. Automatic Temperature or Density Compensation. – A volumetric device shall be equipped with automatic means for adjusting the indication and recorded representation of the measured quantity of the product to indicate or record the quantity of the product measured in terms of pounds.

S.2.5. Provision for Sealing. – Adequate provision shall be made for an approved means of security (e.g., data change audit trail) or for physically applying a security seal in such a manner that requires the security seal to be broken before an adjustment or interchange may be made of:

- (a) any measuring or indicating element;
- (b) any adjustable element for controlling delivery rate when such rate tends to affect the accuracy of deliveries;
- (c) any automatic temperature or density compensating system; and
- (d) any metrological parameter that will affect the metrological integrity of the device or system.

When applicable any adjusting mechanism shall be readily accessible for purposes of affixing a security seal.

*[Audit trails shall use the format set forth in Table S.2.5. Provision for Sealing]**

*[*Nonretroactive as of January 1, 1995]*

(Amended 2006)

| Table S.2.5. Categories of Device and Methods of Sealing | |
|--|--|
| Categories of Device | Methods of Sealing |
| Category 1: <i>No remote configuration capability.</i> | <i>Seal by physical seal or two event counters: one for calibration parameters and one for configuration parameters.</i> |
| Category 2: <i>Remote configuration capability, but access is controlled by physical hardware.</i> <i>The device shall clearly indicate that it is in the remote configuration mode and record such message if capable of printing in this mode or shall not operate while in this mode.</i> | <i>The hardware enabling access for remote communication must be on-site. The hardware must be sealed using a physical seal or an event counter for calibration parameters and an event counter for configuration parameters. The event counters may be located either at the individual measuring device or at the system controller; however, an adequate number of counters must be provided to monitor the calibration and configuration parameters of the individual devices at a location. If the counters are located in the system controller rather than at the individual device, means must be provided to generate a hard copy of the information through an on-site device.</i> |
| Category 3: <i>Remote configuration capability access may be unlimited or controlled through a software switch (e.g., password).</i> <i>The device shall clearly indicate that it is in the remote configuration mode and record such message if capable of printing in this mode or shall not operate while in this mode.</i> | <i>An event logger is required in the device; it must include an event counter (000 to 999), the parameter ID, the date and time of the change, and the new value of the parameter. A printed copy of the information must be available through the device or through another on-site device. The event logger shall have a capacity to retain records equal to 10 times the number of sealable parameters in the device, but not more than 1000 records are required. (Note: Does not require 1000 changes to be stored for each parameter.)</i> |

[Nonretroactive as of January 1, 1995]

(Table Added 2006)

S.3. Design of Discharge Lines and Discharge Line Valves.

S.3.1. Diversion of Measured Liquid. – No means shall be provided by which any measured liquid can be diverted from the measuring chamber of the device or the discharge line therefrom, except that a manually controlled outlet that may be opened for purging or draining the measuring system shall be permitted. Effective means shall be provided to prevent the passage of liquid through any such outlet during normal operation of the device and to indicate clearly and unmistakably when the valve controls are so set as to permit passage of liquid through such outlet.

S.3.2. Discharge Hose. – The discharge hose of a measuring system shall be of a wet hose type with a shutoff valve at its outlet end.

S.4. Marking Requirements.

S.4.1. Limitation of Use. – If a measuring system is intended to measure accurately only liquids having particular properties, or to measure accurately only under specific installation or operating conditions, or to measure accurately only when used in conjunction with specific accessory equipment, these limitations shall be clearly and permanently marked on the device.

S.4.2. Discharge Rates. – A meter shall be marked to show its designed maximum and minimum discharge rates. The marked minimum discharge rate shall not exceed 20 % of the marked maximum discharge rate.

Note: ~~See~~Also see example in Section 3.30. Liquid-Measuring Devices Code, paragraph S.4.4.1. Discharge Rates.
(Note Added 2003)

N. Notes

N.1. Test Liquid. – The test liquid shall be carbon dioxide in a compressed liquid state.

N.2. Vaporization and Volume Change. – Care shall be exercised to reduce vaporization and volume changes to a minimum. When testing by weight, the weigh tank and transfer systems shall be pre-cooled to liquid temperature prior to the start of the test to avoid the venting of vapor from the vessel being weighed.

N.3. Test Drafts.

N.3.1. Gravimetric Test. – Weight test drafts shall be equal to at least the amount delivered by the device in 2 minutes at its maximum discharge rate.

N.3.2. Transfer Standard Test. – When comparing a meter with a calibrated transfer standard, the test draft shall be equal to at least the amount delivered by the device in two minutes at its maximum discharge rate.

N.3.3. Volumetric Prover Test Drafts. – Test drafts shall be equal to at least the amount delivered in 1 minute at its normal discharge rate.

N.4. Testing Procedures.

N.4.1. Normal Tests. – The “normal” test of a device shall be made at the maximum discharge flow rate developed under the conditions of installation. Any additional tests conducted at flow rates down to and including one-half of the sum of the maximum discharge flow rate and the rated minimum discharge flow rate shall be considered normal tests.

N.4.1.1. Repeatability Tests. – Tests for repeatability should include a minimum of three consecutive test drafts of approximately the same size and be conducted under controlled conditions where variations in factors such as temperature, pressure, and flow rate are reduced to the extent that they will not affect the results obtained.

(Added 2002)

N.4.2. Special Tests. – Any test except as set forth in N.4.1. Normal Tests shall be considered a special test. Tests shall be conducted, if possible, to evaluate any special elements or accessories attached to or associated with the device. A device shall be tested at a minimum discharge rate of:

- (a) not less than the marked minimum discharge rate or 20 % of the maximum rated discharge rate of the device, whichever is less; or
- (b) the lowest discharge rate practicable under the conditions of installation.

“Special” tests may be conducted to develop any characteristics of the device anticipated under the conditions of installation.

N.4.3. Density. – Temperature and pressure of the metered test liquid shall be measured during the test for the determination of density or volume correction when applicable. The appropriate correction values shall apply as specified in Table N.4.4.

N.4.4. Automatic Temperature or Density Compensation. – If a device is equipped with an automatic temperature or density compensator, the compensator shall be tested by comparing the quantity indicated or recorded by the device (with the compensator connected and operating) with the actual delivered quantity. The appropriate correction values shall apply as specified in Table N.4.4.

| Temp °F | Pressure | | Liquid Density | | Vapor Density | | Vapor Displacement % |
|---------|----------|--------|----------------|-------------|---------------|--------|----------------------|
| | PSIA | PSIG | lb/gal | (lb-oz)/gal | lb/cu ft | lb/gal | |
| - 30.00 | 177.89 | 163.19 | 9.127 | 9 - 2.0 | 1.989 | 0.266 | 2.9 |
| - 29.75 | 178.75 | 164.05 | 9.122 | 9 - 2.0 | 1.999 | 0.267 | 2.9 |
| - 29.50 | 179.62 | 164.92 | 9.117 | 9 - 1.9 | 2.008 | 0.268 | 2.9 |
| - 29.25 | 180.49 | 165.79 | 9.113 | 9 - 1.8 | 2.018 | 0.270 | 3.0 |
| - 29.00 | 181.36 | 166.67 | 9.108 | 9 - 1.7 | 2.028 | 0.271 | 3.0 |
| - 28.75 | 182.24 | 167.54 | 9.103 | 9 - 1.7 | 2.038 | 0.272 | 3.0 |
| - 28.50 | 183.12 | 168.42 | 9.098 | 9 - 1.6 | 2.048 | 0.274 | 3.0 |
| - 28.25 | 184.00 | 169.31 | 9.094 | 9 - 1.5 | 2.058 | 0.275 | 3.0 |
| - 28.00 | 184.89 | 170.19 | 9.089 | 9 - 1.4 | 2.067 | 0.276 | 3.0 |
| - 27.75 | 185.78 | 171.08 | 9.084 | 9 - 1.3 | 2.077 | 0.278 | 3.1 |
| - 27.50 | 186.67 | 171.98 | 9.080 | 9 - 1.3 | 2.087 | 0.279 | 3.1 |
| - 27.25 | 187.57 | 172.87 | 9.075 | 9 - 1.2 | 2.098 | 0.280 | 3.1 |
| - 27.00 | 188.47 | 173.77 | 9.070 | 9 - 1.1 | 2.108 | 0.282 | 3.1 |
| - 26.75 | 189.37 | 174.67 | 9.065 | 9 - 1.0 | 2.118 | 0.283 | 3.1 |
| - 26.50 | 190.28 | 175.58 | 9.061 | 9 - 1.0 | 2.128 | 0.284 | 3.1 |
| - 26.25 | 191.18 | 176.49 | 9.056 | 9 - 0.9 | 2.138 | 0.286 | 3.2 |
| - 26.00 | 192.10 | 177.40 | 9.051 | 9 - 0.8 | 2.148 | 0.287 | 3.2 |
| - 25.75 | 193.01 | 178.32 | 9.046 | 9 - 0.7 | 2.159 | 0.289 | 3.2 |
| - 25.50 | 193.93 | 179.23 | 9.041 | 9 - 0.7 | 2.169 | 0.290 | 3.2 |
| - 25.25 | 194.85 | 180.16 | 9.037 | 9 - 0.6 | 2.179 | 0.291 | 3.2 |
| - 25.00 | 195.78 | 181.08 | 9.032 | 9 - 0.5 | 2.190 | 0.293 | 3.2 |
| - 24.75 | 196.70 | 182.01 | 9.027 | 9 - 0.4 | 2.200 | 0.294 | 3.3 |
| - 24.50 | 197.64 | 182.94 | 9.022 | 9 - 0.4 | 2.211 | 0.296 | 3.3 |
| - 24.25 | 198.57 | 183.87 | 9.017 | 9 - 0.3 | 2.221 | 0.297 | 3.3 |
| - 24.00 | 199.51 | 184.81 | 9.013 | 9 - 0.2 | 2.232 | 0.298 | 3.3 |
| - 23.75 | 200.45 | 185.75 | 9.008 | 9 - 0.1 | 2.243 | 0.300 | 3.3 |
| - 23.50 | 201.39 | 186.70 | 9.003 | 9 - 0.0 | 2.253 | 0.301 | 3.3 |
| - 23.25 | 202.34 | 187.64 | 8.998 | 9 - 0.0 | 2.264 | 0.303 | 3.4 |
| - 23.00 | 203.29 | 188.60 | 8.993 | 8 - 15.9 | 2.275 | 0.304 | 3.4 |
| - 22.75 | 204.25 | 189.55 | 8.989 | 8 - 15.8 | 2.286 | 0.306 | 3.4 |
| - 22.50 | 205.20 | 190.51 | 8.984 | 8 - 15.7 | 2.296 | 0.307 | 3.4 |
| - 22.25 | 206.16 | 191.47 | 8.979 | 8 - 15.7 | 2.307 | 0.308 | 3.4 |

| Table N.4.4. Automatic Temperature or Density Compensation | | | | | | | |
|---|----------|--------|----------------|-------------|---------------|--------|----------------------|
| Temp °F | Pressure | | Liquid Density | | Vapor Density | | Vapor Displacement % |
| | PSIA | PSIG | lb/gal | (lb-oz)/gal | lb/cu ft | lb/gal | |
| - 22.00 | 207.13 | 192.43 | 8.974 | 8 - 15.6 | 2.318 | 0.310 | 3.5 |
| - 21.75 | 208.09 | 193.40 | 8.969 | 8 - 15.5 | 2.329 | 0.311 | 3.5 |
| - 21.50 | 209.06 | 194.37 | 8.964 | 8 - 15.4 | 2.340 | 0.313 | 3.5 |
| - 21.25 | 210.04 | 195.34 | 8.959 | 8 - 15.4 | 2.351 | 0.314 | 3.5 |
| - 21.00 | 211.02 | 196.32 | 8.955 | 8 - 15.3 | 2.362 | 0.316 | 3.5 |
| - 20.75 | 212.00 | 197.30 | 8.950 | 8 - 15.2 | 2.374 | 0.317 | 3.5 |
| - 20.50 | 212.98 | 198.28 | 8.945 | 8 - 15.1 | 2.385 | 0.319 | 3.6 |
| - 20.25 | 213.97 | 199.27 | 8.940 | 8 - 15.0 | 2.396 | 0.320 | 3.6 |
| - 20.00 | 214.96 | 200.26 | 8.935 | 8 - 15.0 | 2.407 | 0.322 | 3.6 |
| - 19.75 | 215.95 | 201.26 | 8.930 | 8 - 14.9 | 2.419 | 0.323 | 3.6 |
| - 19.50 | 216.95 | 202.25 | 8.925 | 8 - 14.8 | 2.430 | 0.325 | 3.6 |
| - 19.25 | 217.95 | 203.25 | 8.920 | 8 - 14.7 | 2.441 | 0.326 | 3.7 |
| - 19.00 | 218.95 | 204.26 | 8.915 | 8 - 14.6 | 2.453 | 0.328 | 3.7 |
| - 18.75 | 219.96 | 205.27 | 8.911 | 8 - 14.6 | 2.464 | 0.329 | 3.7 |
| - 18.50 | 220.97 | 206.28 | 8.906 | 8 - 14.5 | 2.476 | 0.331 | 3.7 |
| - 18.25 | 221.99 | 207.29 | 8.901 | 8 - 14.4 | 2.488 | 0.333 | 3.7 |
| - 18.00 | 223.01 | 208.31 | 8.896 | 8 - 14.3 | 2.499 | 0.334 | 3.8 |
| - 17.75 | 224.03 | 209.33 | 8.891 | 8 - 14.3 | 2.511 | 0.336 | 3.8 |
| - 17.50 | 225.05 | 210.36 | 8.886 | 8 - 14.2 | 2.523 | 0.337 | 3.8 |
| - 17.25 | 226.08 | 211.38 | 8.881 | 8 - 14.1 | 2.534 | 0.339 | 3.8 |
| - 17.00 | 227.11 | 212.42 | 8.876 | 8 - 14.0 | 2.546 | 0.340 | 3.8 |
| - 16.75 | 228.15 | 213.45 | 8.871 | 8 - 13.9 | 2.558 | 0.342 | 3.9 |
| - 16.50 | 229.18 | 214.49 | 8.866 | 8 - 13.9 | 2.570 | 0.344 | 3.9 |
| - 16.25 | 230.23 | 215.53 | 8.861 | 8 - 13.8 | 2.582 | 0.345 | 3.9 |
| - 16.00 | 231.27 | 216.58 | 8.856 | 8 - 13.7 | 2.594 | 0.347 | 3.9 |
| - 15.75 | 232.32 | 217.62 | 8.851 | 8 - 13.6 | 2.606 | 0.348 | 3.9 |
| - 15.50 | 233.37 | 218.68 | 8.846 | 8 - 13.5 | 2.618 | 0.350 | 4.0 |
| - 15.25 | 234.43 | 219.73 | 8.841 | 8 - 13.5 | 2.630 | 0.352 | 4.0 |
| - 15.00 | 235.49 | 220.79 | 8.836 | 8 - 13.4 | 2.643 | 0.353 | 4.0 |
| - 14.75 | 236.55 | 221.86 | 8.831 | 8 - 13.3 | 2.655 | 0.355 | 4.0 |
| - 14.50 | 237.62 | 222.92 | 8.826 | 8 - 13.2 | 2.667 | 0.357 | 4.0 |
| - 14.25 | 238.69 | 223.99 | 8.821 | 8 - 13.1 | 2.680 | 0.358 | 4.1 |
| - 14.00 | 239.76 | 225.07 | 8.816 | 8 - 13.1 | 2.692 | 0.360 | 4.1 |
| - 13.75 | 240.84 | 226.14 | 8.811 | 8 - 13.0 | 2.704 | 0.362 | 4.1 |
| - 13.50 | 241.92 | 227.22 | 8.806 | 8 - 12.9 | 2.717 | 0.363 | 4.1 |

| Temp °F | Pressure | | Liquid Density | | Vapor Density | | Vapor Displacement % |
|---------|----------|--------|----------------|-------------|---------------|--------|----------------------|
| | PSIA | PSIG | lb/gal | (lb-oz)/gal | lb/cu ft | lb/gal | |
| - 13.25 | 243.00 | 228.31 | 8.801 | 8 - 12.8 | 2.729 | 0.365 | 4.1 |
| - 13.00 | 244.09 | 229.39 | 8.796 | 8 - 12.7 | 2.742 | 0.367 | 4.2 |
| - 12.75 | 245.18 | 230.49 | 8.791 | 8 - 12.7 | 2.755 | 0.368 | 4.2 |
| - 12.50 | 246.28 | 231.58 | 8.786 | 8 - 12.6 | 2.767 | 0.370 | 4.2 |
| - 12.25 | 247.37 | 232.68 | 8.781 | 8 - 12.5 | 2.780 | 0.372 | 4.2 |
| - 12.00 | 248.48 | 233.78 | 8.776 | 8 - 12.4 | 2.793 | 0.373 | 4.3 |
| - 11.75 | 249.58 | 234.89 | 8.771 | 8 - 12.3 | 2.806 | 0.375 | 4.3 |
| - 11.50 | 250.69 | 236.00 | 8.765 | 8 - 12.2 | 2.819 | 0.377 | 4.3 |
| - 11.25 | 251.80 | 237.11 | 8.760 | 8 - 12.2 | 2.832 | 0.379 | 4.3 |
| - 11.00 | 252.92 | 238.22 | 8.755 | 8 - 12.1 | 2.845 | 0.380 | 4.3 |
| - 10.75 | 254.04 | 239.34 | 8.750 | 8 - 12.0 | 2.858 | 0.382 | 4.4 |
| - 10.50 | 255.16 | 240.47 | 8.745 | 8 - 11.9 | 2.871 | 0.384 | 4.4 |
| - 10.25 | 256.29 | 241.60 | 8.740 | 8 - 11.8 | 2.884 | 0.386 | 4.4 |
| - 10.00 | 257.42 | 242.73 | 8.735 | 8 - 11.8 | 2.897 | 0.387 | 4.4 |
| - 9.75 | 258.56 | 243.86 | 8.730 | 8 - 11.7 | 2.911 | 0.389 | 4.5 |
| - 9.50 | 259.70 | 245.00 | 8.725 | 8 - 11.6 | 2.924 | 0.391 | 4.5 |
| - 9.25 | 260.84 | 246.14 | 8.719 | 8 - 11.5 | 2.937 | 0.393 | 4.5 |
| - 9.00 | 261.98 | 247.29 | 8.714 | 8 - 11.4 | 2.951 | 0.394 | 4.5 |
| - 8.75 | 263.13 | 248.44 | 8.709 | 8 - 11.3 | 2.964 | 0.396 | 4.5 |
| - 8.50 | 264.29 | 249.59 | 8.704 | 8 - 11.3 | 2.978 | 0.398 | 4.6 |
| - 8.25 | 265.44 | 250.75 | 8.699 | 8 - 11.2 | 2.991 | 0.400 | 4.6 |
| - 8.00 | 266.60 | 251.91 | 8.694 | 8 - 11.1 | 3.005 | 0.402 | 4.6 |
| - 7.75 | 267.77 | 253.07 | 8.688 | 8 - 11.0 | 3.019 | 0.404 | 4.6 |
| - 7.50 | 268.93 | 254.24 | 8.683 | 8 - 10.9 | 3.032 | 0.405 | 4.7 |
| - 7.25 | 270.11 | 255.41 | 8.678 | 8 - 10.8 | 3.046 | 0.407 | 4.7 |
| - 7.00 | 271.28 | 256.59 | 8.673 | 8 - 10.8 | 3.060 | 0.409 | 4.7 |
| - 6.75 | 272.46 | 257.76 | 8.668 | 8 - 10.7 | 3.074 | 0.411 | 4.7 |
| - 6.50 | 273.64 | 258.95 | 8.662 | 8 - 10.6 | 3.088 | 0.413 | 4.8 |
| - 6.25 | 274.83 | 260.13 | 8.657 | 8 - 10.5 | 3.102 | 0.415 | 4.8 |
| - 6.00 | 276.02 | 261.32 | 8.652 | 8 - 10.4 | 3.116 | 0.417 | 4.8 |
| - 5.75 | 277.21 | 262.52 | 8.647 | 8 - 10.3 | 3.130 | 0.418 | 4.8 |
| - 5.50 | 278.41 | 263.72 | 8.641 | 8 - 10.3 | 3.144 | 0.420 | 4.9 |
| - 5.25 | 279.61 | 264.92 | 8.636 | 8 - 10.2 | 3.159 | 0.422 | 4.9 |
| - 5.00 | 280.82 | 266.12 | 8.631 | 8 - 10.1 | 3.173 | 0.424 | 4.9 |
| - 4.75 | 282.03 | 267.33 | 8.626 | 8 - 10.0 | 3.187 | 0.426 | 4.9 |

| Table N.4.4. Automatic Temperature or Density Compensation | | | | | | | |
|---|----------|--------|----------------|-------------|---------------|--------|----------------------|
| Temp °F | Pressure | | Liquid Density | | Vapor Density | | Vapor Displacement % |
| | PSIA | PSIG | lb/gal | (lb-oz)/gal | lb/cu ft | lb/gal | |
| - 4.50 | 283.24 | 268.55 | 8.620 | 8 - 9.9 | 3.202 | 0.428 | 5.0 |
| - 4.25 | 284.46 | 269.76 | 8.615 | 8 - 9.8 | 3.216 | 0.430 | 5.0 |
| - 4.00 | 285.68 | 270.98 | 8.610 | 8 - 9.8 | 3.231 | 0.432 | 5.0 |
| - 3.75 | 286.90 | 272.21 | 8.604 | 8 - 9.7 | 3.245 | 0.434 | 5.0 |
| - 3.50 | 288.13 | 273.44 | 8.599 | 8 - 9.6 | 3.260 | 0.436 | 5.1 |
| - 3.25 | 289.37 | 274.67 | 8.594 | 8 - 9.5 | 3.275 | 0.438 | 5.1 |
| - 3.00 | 290.60 | 275.91 | 8.589 | 8 - 9.4 | 3.289 | 0.440 | 5.1 |
| - 2.75 | 291.84 | 277.15 | 8.583 | 8 - 9.3 | 3.304 | 0.442 | 5.1 |
| - 2.50 | 293.09 | 278.39 | 8.578 | 8 - 9.2 | 3.319 | 0.444 | 5.2 |
| - 2.25 | 294.33 | 279.64 | 8.573 | 8 - 9.2 | 3.334 | 0.446 | 5.2 |
| - 2.00 | 295.58 | 280.89 | 8.567 | 8 - 9.1 | 3.349 | 0.448 | 5.2 |
| - 1.75 | 296.84 | 282.14 | 8.562 | 8 - 9.0 | 3.364 | 0.450 | 5.3 |
| - 1.50 | 298.10 | 283.40 | 8.556 | 8 - 8.9 | 3.379 | 0.452 | 5.3 |
| - 1.25 | 299.36 | 284.67 | 8.551 | 8 - 8.8 | 3.395 | 0.454 | 5.3 |
| - 1.00 | 300.63 | 285.93 | 8.546 | 8 - 8.7 | 3.410 | 0.456 | 5.3 |
| - 0.75 | 301.90 | 287.21 | 8.540 | 8 - 8.6 | 3.425 | 0.458 | 5.4 |
| - 0.50 | 303.18 | 288.48 | 8.535 | 8 - 8.6 | 3.440 | 0.460 | 5.4 |
| - 0.25 | 304.46 | 289.76 | 8.530 | 8 - 8.5 | 3.456 | 0.462 | 5.4 |
| 0.00 | 305.74 | 291.74 | 8.524 | 8 - 8.4 | 3.471 | 0.464 | 5.4 |
| 0.25 | 307.03 | 292.33 | 8.519 | 8 - 8.3 | 3.487 | 0.466 | 5.5 |
| 0.50 | 308.32 | 293.62 | 8.513 | 8 - 8.2 | 3.503 | 0.468 | 5.5 |
| 0.75 | 309.61 | 294.92 | 8.508 | 8 - 8.1 | 3.518 | 0.470 | 5.5 |
| 1.00 | 310.91 | 296.21 | 8.502 | 8 - 8.0 | 3.534 | 0.472 | 5.6 |
| 1.25 | 312.21 | 297.52 | 8.497 | 8 - 8.0 | 3.550 | 0.475 | 5.6 |
| 1.50 | 313.52 | 298.82 | 8.491 | 8 - 7.9 | 3.566 | 0.477 | 5.6 |
| 1.75 | 314.83 | 300.13 | 8.486 | 8 - 7.8 | 3.582 | 0.479 | 5.6 |
| 2.00 | 316.15 | 301.45 | 8.480 | 8 - 7.7 | 3.598 | 0.481 | 5.7 |
| 2.25 | 317.46 | 302.77 | 8.475 | 8 - 7.6 | 3.614 | 0.483 | 5.7 |
| 2.50 | 318.79 | 304.09 | 8.469 | 8 - 7.5 | 3.630 | 0.485 | 5.7 |
| 2.75 | 320.11 | 305.42 | 8.464 | 8 - 7.4 | 3.646 | 0.487 | 5.8 |
| 3.00 | 321.45 | 306.75 | 8.458 | 8 - 7.3 | 3.662 | 0.490 | 5.8 |
| 3.25 | 322.78 | 308.08 | 8.453 | 8 - 7.2 | 3.679 | 0.492 | 5.8 |
| 3.50 | 324.12 | 309.42 | 8.447 | 8 - 7.2 | 3.695 | 0.494 | 5.8 |
| 3.75 | 325.46 | 310.77 | 8.442 | 8 - 7.1 | 3.712 | 0.496 | 5.9 |
| 4.00 | 326.81 | 312.11 | 8.436 | 8 - 7.0 | 3.728 | 0.498 | 5.9 |

| Temp °F | Pressure | | Liquid Density | | Vapor Density | | Vapor Displacement % |
|---------|----------|--------|----------------|-------------|---------------|--------|----------------------|
| | PSIA | PSIG | lb/gal | (lb-oz)/gal | lb/cu ft | lb/gal | |
| 4.25 | 328.16 | 313.46 | 8.431 | 8 - 6.9 | 3.745 | 0.501 | 5.9 |
| 4.50 | 329.52 | 314.82 | 8.425 | 8 - 6.8 | 3.761 | 0.503 | 6.0 |
| 4.75 | 330.88 | 316.18 | 8.420 | 8 - 6.7 | 3.778 | 0.505 | 6.0 |
| 5.00 | 332.24 | 317.54 | 8.414 | 8 - 6.6 | 3.795 | 0.507 | 6.0 |
| 5.25 | 333.61 | 318.91 | 8.408 | 8 - 6.5 | 3.812 | 0.510 | 6.1 |
| 5.50 | 334.98 | 320.28 | 8.403 | 8 - 6.4 | 3.829 | 0.512 | 6.1 |
| 5.75 | 336.35 | 321.66 | 8.397 | 8 - 6.4 | 3.846 | 0.514 | 6.1 |
| 6.00 | 337.73 | 323.04 | 8.392 | 8 - 6.3 | 3.863 | 0.516 | 6.2 |
| 6.25 | 339.12 | 324.42 | 8.386 | 8 - 6.2 | 3.880 | 0.519 | 6.2 |
| 6.50 | 340.51 | 325.81 | 8.380 | 8 - 6.1 | 3.897 | 0.521 | 6.2 |
| 6.75 | 341.90 | 327.20 | 8.375 | 8 - 6.0 | 3.915 | 0.523 | 6.3 |
| 7.00 | 343.30 | 328.60 | 8.369 | 8 - 5.9 | 3.932 | 0.526 | 6.3 |
| 7.25 | 344.70 | 330.00 | 8.363 | 8 - 5.8 | 3.949 | 0.528 | 6.3 |
| 7.50 | 346.10 | 331.41 | 8.358 | 8 - 5.7 | 3.967 | 0.530 | 6.3 |
| 7.75 | 347.51 | 332.82 | 8.352 | 8 - 5.6 | 3.984 | 0.533 | 6.4 |
| 8.00 | 348.92 | 334.23 | 8.346 | 8 - 5.5 | 4.002 | 0.535 | 6.4 |
| 8.25 | 350.34 | 335.65 | 8.341 | 8 - 5.4 | 4.020 | 0.537 | 6.4 |
| 8.50 | 351.76 | 337.07 | 8.335 | 8 - 5.4 | 4.038 | 0.540 | 6.5 |
| 8.75 | 353.19 | 338.49 | 8.335 | 8 - 5.4 | 4.038 | 0.540 | 6.5 |
| 9.00 | 354.62 | 339.92 | 8.323 | 8 - 5.2 | 4.073 | 0.545 | 6.5 |
| 9.25 | 356.06 | 341.36 | 8.318 | 8 - 5.1 | 4.091 | 0.547 | 6.6 |
| 9.50 | 357.49 | 342.80 | 8.312 | 8 - 5.0 | 4.110 | 0.549 | 6.6 |
| 9.75 | 358.94 | 344.24 | 8.306 | 8 - 4.9 | 4.128 | 0.552 | 6.6 |
| 10.00 | 360.38 | 345.69 | 8.300 | 8 - 4.8 | 4.146 | 0.554 | 6.7 |
| 10.25 | 361.84 | 347.14 | 8.295 | 8 - 4.7 | 4.164 | 0.557 | 6.7 |
| 10.50 | 363.29 | 348.60 | 8.289 | 8 - 4.6 | 4.183 | 0.559 | 6.7 |
| 10.75 | 364.75 | 350.06 | 8.283 | 8 - 4.5 | 4.201 | 0.562 | 6.8 |
| 11.00 | 366.22 | 351.52 | 8.277 | 8 - 4.4 | 4.220 | 0.564 | 6.8 |
| 11.25 | 367.68 | 352.99 | 8.271 | 8 - 4.3 | 4.238 | 0.567 | 6.8 |
| 11.50 | 369.16 | 354.46 | 8.266 | 8 - 4.2 | 4.257 | 0.569 | 6.9 |
| 11.75 | 370.64 | 355.94 | 8.260 | 8 - 4.2 | 4.276 | 0.572 | 6.9 |
| 12.00 | 372.12 | 357.42 | 8.254 | 8 - 4.1 | 4.295 | 0.574 | 7.0 |
| 12.25 | 373.60 | 358.91 | 8.248 | 8 - 4.0 | 4.314 | 0.577 | 7.0 |
| 12.50 | 375.09 | 360.40 | 8.242 | 8 - 3.9 | 4.333 | 0.579 | 7.0 |
| 12.75 | 376.59 | 361.89 | 8.236 | 8 - 3.8 | 4.352 | 0.582 | 7.1 |

| Table N.4.4. | | | | | | | |
|--|-----------------|-------------|-----------------------|--------------------|----------------------|---------------|-----------------------------|
| Automatic Temperature or Density Compensation | | | | | | | |
| Temp °F | Pressure | | Liquid Density | | Vapor Density | | Vapor Displacement % |
| | PSIA | PSIG | lb/gal | (lb-oz)/gal | lb/cu ft | lb/gal | |
| 13.00 | 378.09 | 363.39 | 8.230 | 8 - 3.7 | 4.371 | 0.584 | 7.1 |
| 13.25 | 379.59 | 364.89 | 8.224 | 8 - 3.6 | 4.390 | 0.587 | 7.1 |
| 13.50 | 381.10 | 366.40 | 8.219 | 8 - 3.5 | 4.410 | 0.589 | 7.2 |
| 13.75 | 382.61 | 367.91 | 8.213 | 8 - 3.4 | 4.429 | 0.592 | 7.2 |
| 14.00 | 384.13 | 369.43 | 8.207 | 8 - 3.3 | 4.449 | 0.595 | 7.2 |
| 14.25 | 385.65 | 370.95 | 8.201 | 8 - 3.2 | 4.468 | 0.597 | 7.3 |
| 14.50 | 387.17 | 372.48 | 8.195 | 8 - 3.1 | 4.488 | 0.600 | 7.3 |
| 14.75 | 388.70 | 374.01 | 8.189 | 8 - 3.0 | 4.508 | 0.603 | 7.4 |
| 15.00 | 390.24 | 375.54 | 8.183 | 8 - 2.9 | 4.527 | 0.605 | 7.4 |
| 15.25 | 391.78 | 377.08 | 8.177 | 8 - 2.8 | 4.547 | 0.608 | 7.4 |
| 15.50 | 393.32 | 378.62 | 8.171 | 8 - 2.7 | 4.567 | 0.611 | 7.5 |
| 15.75 | 394.87 | 380.17 | 8.165 | 8 - 2.6 | 4.587 | 0.613 | 7.5 |
| 16.00 | 396.42 | 381.72 | 8.159 | 8 - 2.5 | 4.608 | 0.616 | 7.5 |
| 16.25 | 397.98 | 383.28 | 8.153 | 8 - 2.4 | 4.628 | 0.619 | 7.6 |
| 16.50 | 399.54 | 384.84 | 8.147 | 8 - 2.3 | 4.648 | 0.621 | 7.6 |
| 16.75 | 401.10 | 386.41 | 8.141 | 8 - 2.2 | 4.669 | 0.624 | 7.7 |
| 17.00 | 402.67 | 387.98 | 8.134 | 8 - 2.2 | 4.689 | 0.627 | 7.7 |
| 17.25 | 404.25 | 389.55 | 8.128 | 8 - 2.1 | 4.710 | 0.630 | 7.7 |
| 17.50 | 405.82 | 391.13 | 8.122 | 8 - 2.0 | 4.731 | 0.632 | 7.8 |
| 17.75 | 407.41 | 392.71 | 8.116 | 8 - 1.9 | 4.751 | 0.635 | 7.8 |
| 18.00 | 409.00 | 394.30 | 8.110 | 8 - 1.8 | 4.772 | 0.638 | 7.9 |
| 18.25 | 410.59 | 395.89 | 8.104 | 8 - 1.7 | 4.793 | 0.641 | 7.9 |
| 18.50 | 412.19 | 397.49 | 8.098 | 8 - 1.6 | 4.814 | 0.644 | 7.9 |
| 18.75 | 413.79 | 399.09 | 8.092 | 8 - 1.5 | 4.835 | 0.646 | 8.0 |
| 19.00 | 415.39 | 400.70 | 8.085 | 8 - 1.4 | 4.857 | 0.649 | 8.0 |
| 19.25 | 417.00 | 402.31 | 8.079 | 8 - 1.3 | 4.878 | 0.652 | 8.1 |
| 19.50 | 418.62 | 403.92 | 8.073 | 8 - 1.2 | 4.900 | 0.655 | 8.1 |
| 19.75 | 420.24 | 405.54 | 8.067 | 8 - 1.1 | 4.921 | 0.658 | 8.2 |
| 20.00 | 421.86 | 407.17 | 8.061 | 8 - 1.0 | 4.943 | 0.661 | 8.2 |

T. Tolerances

T.1. Application.

T.1.1. To Underregistration and to Overregistration. – The tolerances hereinafter prescribed shall be applied to errors of underregistration and errors of overregistration.

T.2. Tolerance Values. – The maintenance and acceptance tolerances for normal and special tests shall be as shown in Table T.2. Accuracy Classes and Tolerances for Carbon Dioxide Liquid-Measuring Devices.

| Accuracy Class | Application | Acceptance Tolerance | Maintenance Tolerance | Special Test Tolerance |
|----------------|-----------------------|----------------------|-----------------------|------------------------|
| 2.5 | Liquid carbon dioxide | 1.5 % | 2.5 % | 2.5 % |

(Table Added 2003) (Amended 2003)

T.2.1. Repeatability. – When multiple tests are conducted at approximately the same flow rate and draft size, the range of the test results for the flow rate shall not exceed 40 % of the absolute value of the maintenance tolerance and the results of each test shall be within the applicable tolerance—~~(. (Also see also N.4.1.1. Repeatability Tests).)~~

(Added 2002)

T.3. On Tests Using Transfer Standards. – To the basic tolerance values that would otherwise be applied, there shall be added an amount equal to two times the standard deviation of the applicable transfer standard when compared to a basic reference standard.

UR. User Requirements

UR.1. Installation Requirements.

UR.1.1. Discharge Rate. – A device shall be so installed that the actual maximum discharge rate will not exceed the rated maximum discharge rate. If necessary, means for flow regulation shall be incorporated in the installation.

UR.1.2. Length of Discharge Hose. – The discharge hose shall be of such a length and design as to keep vaporization of the liquid to a minimum.

UR.1.3. Maintenance of Liquid State. – A device shall be so installed and operated that the product being measured shall remain in the liquid state during passage through the meter.

UR.2. Use Requirements.

UR.2.1. Return of Indicating and Recording Elements to Zero. – The primary indicating elements (visual) and the primary recording elements shall be returned to zero immediately before each delivery.

UR.2.2. Condition of Discharge System. – The discharge hose, up to the valve at the end of the discharge hose, shall be completely filled and pre-cooled to liquid temperatures before a “zero” condition is established

and prior to the start of a commercial delivery. Means shall be provided to fill the discharge hose with liquid prior to the start of a delivery.

UR.2.3. Vapor Equalization Line. – A vapor equalization line shall not be used during a metered delivery unless the quantity of vapor displaced from the buyer's tank to the seller's tank is deducted from the metered quantity. The appropriate correction values shall apply as specified in Table N.4.4.

UR.2.4. Temperature or Density Compensation.

UR.2.4.1. Use of Automatic Temperature or Density Compensators. – Devices equipped with an automatic temperature or density compensator shall have the compensator connected, operable, and in use at all times. Such automatic temperature or density compensator may not be removed.

UR.2.4.2. Tickets or Invoices. – Any written invoice or printed ticket based on a reading of a device that is equipped with an automatic temperature or density compensator shall have shown thereon that the quantity delivered has been temperature or density compensated.

UR.2.5. Ticket in Printing Device. – A ticket shall not be inserted into a device equipped with a ticket printer until immediately before a delivery is begun, and in no case shall a ticket be in the device when the vehicle is in motion while on a public street, highway, or thoroughfare.

UR.2.6. Sale by Weight. – All quantity determinations shall be made by means of an approved and sealed weighing or measuring device. All sales shall be stated in kilograms or pounds.

THIS PAGE INTENTIONALLY LEFT BLANK

MARKUP COPY

Section 3.39. Hydrogen Gas-Measuring Devices – Tentative Code

This tentative code has only a trial or experimental status and is not intended to be enforced. The requirements are designed for study prior to the development and adoption of a final code. Requirements that apply to wholesale applications are under study and development by the U.S. National Work Group for the Development of Commercial Hydrogen Measurement Standards. Officials wanting to conduct an official examination of a device or system are advised to see paragraph G-A.3. Special and Unclassified Equipment.

(Tentative Code Added 2010)

A. Application

A.1. General. – This code applies to devices that are used for the measurement of hydrogen gas in the vapor state used as a vehicle fuel.

A.2. Exceptions. – This code does not apply to:

- (a) Devices used solely for dispensing a product in connection with operations in which the amount dispensed does not affect customer charges.
- (b) The wholesale delivery of hydrogen gas.
- (c) Devices used for dispensing a hydrogen gas with a hydrogen fuel index lower than 99.97 % and concentrations of specified impurities that exceed level limits.
- (d) Systems that measure pressure, volume, and temperature with a calculating device to determine the mass of gas accumulated in or discharged from a tank of known volume.

A.3. Additional Code Requirements. – In addition to the requirements of this code, Hydrogen Gas-Measuring Devices shall meet the requirements of Section 1.10. General Code.

A.4. Type Evaluation. – The National Type Evaluation Program (NTEP) will accept for type evaluation only those devices that comply with all requirements of this code.

S. Specifications

S.1. Indicating and Recording Elements.

S.1.1. Indicating Elements. – A measuring assembly shall include an indicating element that continuously displays measurement results relative to quantity and total price. Indications shall be clear, definite, accurate, and easily read under normal conditions of operation of the device.

S.1.2. Vehicle Fuel Dispensers. – A hydrogen gas dispenser used to fuel vehicles shall be of the computing type and shall indicate the mass, the unit price, and the total price of each delivery.

S.1.3. Units.

S.1.3.1. Units of Measurement. – Deliveries shall be indicated and recorded in kilograms and decimal subdivisions thereof.

S.1.3.2. Numerical Value of Quantity-Value Divisions. – The value of an interval (i.e., increment or scale division) shall be equal to:

- (a) 1, 2, or 5; or
- (b) a decimal multiple or submultiple of 1, 2, or 5.

Examples: quantity-value divisions may be 10, 20, 50, 100; or 0.01, 0.02, 0.05; or 0.1, 0.2, or 0.5 etc.

S.1.3.3. Maximum Value of Quantity-Value Divisions. – The maximum value of the quantity-value division shall not be greater than 0.5% of the minimum measured quantity.

S.1.3.4. Values Defined. – Indicated values shall be adequately defined by a sufficient number of figures, words, symbols, or combinations thereof. A display of “zero” shall be a zero digit for all displayed digits to the right of the decimal mark and at least one to the left.

S.1.4. Value of Smallest Unit. – The value of the smallest unit of indicated delivery, and recorded delivery if the device is equipped to record, shall not exceed the equivalent of:

- (a) 0.001 kg on devices with a marked maximum flow rated of 30 kg/min or less; or
- (b) 0.01 kg on devices with a marked maximum flow rate of more than 30 kg/min.

S.2. Operating Requirements.

S.2.1. Return to Zero.

- (a) The primary indicating and the primary recording elements, if the device is equipped to record, shall be provided with a means for readily returning the indication to zero either automatically or manually.
- (b) It shall not be possible to return primary indicating elements, or primary recording elements, beyond the correct zero position.

S.2.2. Indicator Reset Mechanism. – The reset mechanism for the indicating element shall not be operable during a delivery. Once the zeroing operation has begun, it shall not be possible to indicate a value other than the latest measurement, or “zeros” when the zeroing operation has been completed.

S.2.3. Provision for Power Loss.

S.2.3.1. Transaction Information. – In the event of a power loss, the information needed to complete any transaction in progress at the time of the power loss (such as the quantity and unit price, or sales price) shall be determinable for at least 15 minutes at the dispenser or at the console if the console is accessible to the customer.

S.2.3.2. User Information. – The device memory shall retain information on the quantity of fuel dispensed and the sales price totals during power loss.

S.2.4. Display of Unit Price and Product Identity.

S.2.4.1. Unit Price. – A computing or money-operated device shall be able to display on each face the unit price at which the device is set to compute or to dispense.

S.2.4.2. Product Identity. – A device shall be able to conspicuously display on each side the identity of the product being dispensed.

S.2.4.3. Selection of Unit Price. – When a product is offered for sale at more than one unit price through a computing device, the selection of the unit price shall be made prior to delivery using controls on the device or other customer-activated controls. A system shall not permit a change to the unit price during delivery of a product.

S.2.4.4. Agreement Between Indications. – All quantity, unit price, and total price indications within a measuring system shall agree for each transaction.

S.2.5. Money-Value Computations. – A computing device shall compute the total sales price at any single-purchase unit price for which the product being measured is offered for sale at any delivery possible within either the measurement range of the device or the range of the computing elements, whichever is less.

S.2.5.1. Auxiliary Elements. – If a system is equipped with auxiliary indications, all indicated money value and quantity divisions of the auxiliary element shall be identical with those of the primary element.

S.2.5.2. Display of Quantity and Total Price. – When a delivery is completed, the total price and quantity for that transaction shall be displayed on the face of the dispenser for at least 5 minutes or until the next transaction is initiated by using controls on the device or other user-activated controls.

S.2.6. Recorded Representations, Point of Sale Systems. – A printed receipt shall be available through a built-in or separate recording element for transactions conducted with point-of-sale systems or devices activated by debit cards, credit cards, and/or cash. The printed receipt shall contain the following information for products delivered by the dispenser:

- (a) the total mass of the delivery;
- (b) the unit price;
- (c) the total computed price; and
- (d) the product identity by name, symbol, abbreviation, or code number.

S.2.7. Indication of Delivery. – The device shall automatically show on its face the initial zero condition and the quantity delivered (up to the nominal capacity).

S.3. Design of Measuring Elements and Measuring Systems.

S.3.1. Maximum and Minimum Flow-Rates. – The ratio of the maximum to minimum flow-rates specified by the manufacturer for devices measuring gases shall be 10:1 or greater.

S.3.2. Adjustment Means. – An assembly shall be provided with means to change the ratio between the indicated quantity and the quantity of gas measured by the assembly. A bypass on the measuring assembly shall not be used for these means.

S.3.2.1. Discontinuous Adjusting Means. – When the adjusting means changes ratio between the indicated quantity and the quantity of measured gas in a discontinuous manner, the consecutive values of the ratio shall not differ by more than 0.1 %.

S.3.3. Provision for Sealing. – Adequate provision shall be made for an approved means of security (e.g., data change audit trail) or physically applying security seals in such a manner that no adjustment may be made of:

- (a) each individual measurement element;
- (b) any adjustable element for controlling delivery rate when such rate tends to affect the accuracy of deliveries;
- (c) the zero adjustment mechanism; and
- (d) any metrological parameter that detrimentally affects the metrological integrity of the device or system.

When applicable, the adjusting mechanism shall be readily accessible for purposes of affixing a security seal. Audit trails shall use the format set forth in Table S.3.3. Categories of Device and Methods of Sealing.

| Table S.3.3. Categories of Device and Methods of Sealing | |
|---|--|
| Categories of Device | Method of Sealing |
| <p>Category 1: No remote configuration capability.</p> | <p>Seal by physical seal or two event counters: one for calibration parameters and one for configuration parameters.</p> |
| <p>Category 2: Remote configuration capability, but access is controlled by physical hardware.</p> <p>The device shall clearly indicate that it is in the remote configuration mode and record such message if capable of printing in this mode or shall not operate while in this mode.</p> | <p>The hardware enabling access for remote communication must be on-site. The hardware must be sealed using a physical seal or an event counter for calibration parameters and an event counter for configuration parameters. The event counters may be located either at the individual measuring device or at the system controller; however, an adequate number of counters must be provided to monitor the calibration and configuration parameters of the individual devices at a location. If the counters are located in the system controller rather than at the individual device, means must be provided to generate a hard copy of the information through an on-site device.</p> |
| <p>Category 3: Remote configuration capability access may be unlimited or controlled through a software switch (e.g., password).</p> <p>The device shall clearly indicate that it is in the remote configuration mode and record such message if capable of printing in this mode or shall not operate while in this mode.</p> | <p>An event logger is required in the device; it must include an event counter (000 to 999), the parameter ID, the date and time of the change, and the new value of the parameter. A printed copy of the information must be available through the device or through another on-site device. The event logger shall have a capacity to retain records equal to 10 times the number of sealable parameters in the device, but not more than 1000 records are required. (Note: Does not require 1000 changes to be stored for each parameter.)</p> |

S.3.4. Automatic Density Correction.

- (a) An automatic means to determine and correct for changes in product density shall be incorporated in any hydrogen gas-measuring system where measurements are affected by changes in the density of the product being measured.
- (b) Volume-measuring devices with automatic temperature compensation used to measure hydrogen gas as a vehicle fuel shall be equipped with an automatic means to determine and correct for changes in product density due to changes in the temperature, pressure, and composition of the product.

S.3.5. Pressurizing the Discharge Hose. – The discharge hose for hydrogen gas shall automatically pressurize to a pressure equal to or greater than the receiving vessel prior to the device beginning to register the delivery. The indications shall not advance as a result of the initial pressurization or the purging/bleeding of the discharge hose.

S.3.6. Zero-Set-Back Interlock, Retail Vehicle Fuel Devices.

- (a) A device shall be constructed so that:

- (1) when the device is shut-off at the end of a delivery an automatic interlock prevents a subsequent delivery until the indicating element and recording elements, if the device is equipped and activated to record, have been returned to their zero positions; and
 - (2) it shall not be possible to return the discharge nozzle to its start position unless the zero set back interlock is engaged or becomes engaged.
- (b) For systems with more than one:
- (1) dispenser supplied by a single measuring element, an effective automatic control valve in each dispenser prevents product from being delivered until the indicating elements on that dispenser are in a correct zero position; or
 - (2) hose supplied by a single measuring element, effective automatic means must be provided to prevent product from being delivered until the indicating element(s) corresponding to each hose are in a correct zero position.

S.4. Discharge Lines and Valves.

S.4.1. Diversion of Measured Product. – No means shall be provided by which any measured product can be diverted from the measuring device.

S.4.2. Directional Flow Valves. – If a reversal of flow could result in errors that exceed the tolerance for the minimum measured quantity, a valve or valves or other effective means, automatic in operation (and equipped with a pressure limiting device, if necessary) to prevent the reversal of flow shall be properly installed in the system. (See Also see N.1. Minimum Measured Quantity.)

S.4.3. Other Valves. – Check valves and closing mechanisms that are not used to define the measured quantity shall have relief valves (if necessary) to dissipate any abnormally high pressure that may arise in the measuring assembly.

S.5. Markings. – A measuring system shall be conspicuously, legibly, and indelibly marked with the following information:

- (a) pattern approval mark (i.e., type approval number);
- (b) name and address of the manufacturer or his trademark and, if required by the weights and measures authority, the manufacturer's identification mark in addition to the trademark;
- (c) model designation or product name selected by the manufacturer;
- (d) nonrepetitive serial number;
- (e) the accuracy class of the device as specified by the manufacturer consistent with Table T.2. Accuracy Classes and Tolerances for Hydrogen-Gas Measuring Devices;
- (f) maximum and minimum flow rates in kilograms per unit of time;
- (g) maximum working pressure;
- (h) applicable range of ambient temperature if other than $-10\text{ }^{\circ}\text{C}$ to $+50\text{ }^{\circ}\text{C}$;
- (i) minimum measured quantity; and
- (j) product limitations (such as fuel quality), if applicable.

S.5.1. Location of Marking Information; Hydrogen-Fuel Dispensers. – The marking information required in General Code, paragraph G S.1. Identification shall appear as follows:

- (a) within 60 cm (24 in) to 150 cm (60 in) from the base of the dispenser;
- (b) either internally and/or externally provided the information is permanent and easily read; and accessible for inspection; and
- (c) on a portion of the device that cannot be readily removed or interchanged (i.e., not on a service access panel).

Note: The use of a dispenser key or tool to access internal marking information is permitted for retail hydrogen-measuring devices.

S.6. Printer. – When an assembly is equipped with means for printing the measured quantity, the printed information must agree with the indications on the dispenser for the transaction and the printed values shall be clearly defined.

S.6.1. Printed Receipt. – Any delivered, printed quantity shall include an identification number, the time and date, and the name of the seller. This information may be printed by the device or pre-printed on the ticket.

S.7. Totalizers for Vehicle Fuel Dispensers. – Vehicle fuel dispensers shall be equipped with a nonresettable totalizer for the quantity delivered through each separate measuring device.

S.8. Minimum Measured Quantity. – The minimum measured quantity shall satisfy the conditions of use of the measuring system as follows:

- (a) Measuring systems having a maximum flow rate less than or equal to 4 kg/min shall have a minimum measured quantity not exceeding 0.5 kg.
- (b) Measuring systems having a maximum flow rate greater than 4 kg/min but not greater than 12 kg/min shall have a minimum measured quantity not exceeding 1.0 kg.

N. Notes

N.1. Minimum Measured Quantity. – The minimum measured quantity shall be specified by the manufacturer.

N.2. Test Medium. – The device shall be tested with the product commercially measured except that, in a type evaluation examination, hydrogen gas as specified in NIST Handbook 130 shall be used.

Note: Corresponding requirements are under development and this paragraph will be revisited.

N.3. Test Drafts. – The minimum test shall be one test draft at the declared minimum measured quantity and one test draft at approximately ten times the minimum measured quantity or 1 kg, whichever is greater. More tests may be performed over the range of normal quantities dispensed. (See Also see T.3. Repeatability.)

The test draft shall be made at flows representative of that during normal delivery. The pressure drop between the dispenser and the proving system shall not be greater than that for normal deliveries. The control of the flow (e.g., pipework or valve(s) size, etc.) shall be such that the flow of the measuring system is maintained within the range specified by the manufacturer.

N.4. Tests.

N.4.1. Master Meter (Transfer) Standard Test. – When comparing a measuring system with a calibrated transfer standard, the minimum test shall be one test draft at the declared minimum measured

quantity and one test draft at approximately ten times the minimum measured quantity or 1 kg, whichever is greater. More tests may be performed over the range of normal quantities dispensed.

N.4.1.1. Verification of Master Metering Systems. – A master metering system used to verify a hydrogen gas-measuring device shall be verified before and after the verification process. A master metering system used to calibrate a hydrogen gas-measuring device shall be verified before starting the calibration and after the calibration process.

N.4.2. Gravimetric Tests. – The weight of the test drafts shall be equal to at least the amount delivered by the device at the declared minimum measured quantity and one test draft at approximately ten times the minimum measured quantity or 1 kg, whichever is greater. More tests may be performed over the range of normal quantities dispensed.

N.4.3. PVT Pressure Volume Temperature Test. – The minimum test with a calibrated volumetric standard shall be one test draft at the declared minimum measured quantity and one test draft at approximately ten times the minimum measured quantity or 1 kg, whichever is greater. More tests may be performed over the range of normal quantities dispensed.

N.5. Minimum Measured Quantity. – The device shall be tested for a delivery equal to the declared minimum measured quantity when the device is likely to be used to make deliveries on the order of the declared minimum measured quantity.

N.6. Testing Procedures.

N.6.1. General. – The device or system shall be tested under normal operating conditions of the dispenser.

The test draft shall be made at flows representative of that during normal delivery. The pressure drop between the dispenser and the proving system shall not be greater than that for normal deliveries. The control of the flow (e.g., pipework or valve(s) size, etc.) shall be such that the flow of the measuring system is maintained within the range specified by the manufacturer.

N.6.1.1. Repeatability Tests. – Tests for repeatability should include a minimum of three consecutive test drafts of approximately the same size and be conducted under controlled conditions where variations in factors are reduced to minimize the effect on the results obtained.

N.7. Density. – Temperature and pressure of hydrogen gas shall be measured during the test for the determination of density or volume correction factors when applicable. For the thermophysical properties of hydrogen the following publications shall apply: for density calculations at temperatures above 255 K and pressures up to 120 MPa, a simple relationship may be used that is given in the publication of Lemmon et al., J. Res. NIST, 2008. Calculations for a wider range of conditions and additional thermophysical properties of hydrogen are available free of charge online at the “NIST Chemistry WebBook” <http://webbook.nist.gov/chemistry>, or available for purchase from NIST as the computer program NIST Standard Reference Database 23 “NIST Reference Fluid Thermodynamic and Transport Properties Database (REFPROP): Version 8.0” <http://www.nist.gov/srd/nist23.cfm>. These calculations are based on the reference Leachman, J.W., Jacobsen, R.T, Lemmon, E.W., and Penoncello, S.G. “Fundamental Equations of State for Parahydrogen, Normal Hydrogen, and Orthohydrogen” to be published in the Journal of Physical and Chemical Reference Data (http://www.nist.gov/manuscript-publication-search.cfm?pub_id=832374). More information may be obtained from NIST online at <http://www.boulder.nist.gov/div838/Hydrogen/Index.htm>.

T. Tolerances

T.1. Tolerances, General.

- (a) The tolerances apply equally to errors of underregistration and errors of overregistration.
- (b) The tolerances apply to all products at all temperatures measured at any flow rate within the rated measuring range of the device.

T.2. Tolerances. – The tolerances for hydrogen gas measuring devices are listed in Table T.2. Accuracy Classes and Tolerances for Hydrogen Gas-Measuring Devices. (Proposed tolerance values are based on previous work with compressed gas products and will be confirmed based on performance data evaluated by the U.S. National Work Group.)

| Table T.2. Accuracy Classes and Tolerances for Hydrogen Gas-Measuring Devices | | | |
|--|---|----------------------|-----------------------|
| Accuracy Class | Application or Commodity Being Measured | Acceptance Tolerance | Maintenance Tolerance |
| 2.0 | Hydrogen gas as a vehicle fuel | 1.5 % | 2.0 % |

T.3. Repeatability. – When multiple tests are conducted at approximately the same flow rate and draft size, the range of the test results for the flow rate shall not exceed 40 % of the absolute value of the maintenance tolerance and the results of each test shall be within the applicable tolerance. See (Also see also N.6.1.1. Repeatability Tests.)

T.4. Tolerance Application on Test Using Transfer Standard Test Method. – To the basic tolerance values that would otherwise be applied, there shall be added an amount equal to two times the standard deviation of the applicable transfer standard when compared to a basic reference standard.

T.5. Tolerance Application in Type Evaluation Examinations for Devices. – For type evaluation examinations, the tolerance values shall apply under the following conditions:

- (a) at any temperature and pressure within the operating range of the device, and
- (b) for all quantities greater than the minimum measured quantity.

UR. User Requirements

UR.1. Selection Requirements.

UR.1.1. Computing-Type Device; Retail Dispenser. – A hydrogen gas dispenser used to refuel vehicles shall be of the computing type and shall indicate the mass, the unit price, and the total price of each delivery.

UR.1.2. Discharge Hose-Length. – The length of the discharge hose on a retail fuel dispenser:

- (a) shall not exceed 4.6 m (15 ft) unless it can be demonstrated that a longer hose is essential to permit deliveries to be made to receiving vehicles or vessels;
- (b) shall be measured from its housing or outlet of the discharge line to the inlet of the discharge nozzle; and

- (c) shall be measured with the hose fully extended if it is coiled or otherwise retained or connected inside a housing.

An unnecessarily remote location of a device shall not be accepted as justification for an abnormally long hose.

UR.1.3. Minimum Measured Quantity.

- (a) The minimum measured quantity shall be specified by the manufacturer.
- (b) The minimum measured quantity appropriate for a transaction may be specified by the weights and measures authority. A device may have a declared minimum measured quantity smaller than that specified by the weights and measures authority; however, the device must perform within the performance requirements for the declared or specified minimum measured quantity up to deliveries at the maximum measurement range.
- (c) The minimum measured quantity shall satisfy the conditions of use of the measuring system as follows:
 - (1) measuring systems having a maximum flow rate less than or equal to 4 kg/min shall have a minimum measured quantity not exceeding 0.5 kg; and
 - (2) measuring systems having a maximum flow rate greater than 4 kg/min but not greater than 12 kg/min shall have a minimum measured quantity not exceeding 1.0 kg.

UR.2. Installation Requirements.

UR.2.1. Manufacturer's Instructions. – A device shall be installed in accordance with the manufacturer's instructions, and the installation shall be sufficiently secure and rigid to maintain this condition.

UR.2.2. Discharge Rate. – A device shall be installed so that after initial equalization the actual maximum discharge rate will not exceed the rated maximum discharge rate. Automatic means of flow regulation shall be incorporated in the installation if necessary.

UR.2.3. Low-Flow Cut-Off Valve. – If a measuring system is equipped with a programmable or adjustable "low-flow cut-off" feature:

- (a) the low-flow cut-off value shall not be set at flow rates lower than the minimum operating flow rate specified by the manufacturer on the measuring device; and
- (b) the system shall be equipped with flow control valves which prevent the flow of product and stop the indicator from registering product flow whenever the product flow rate is less than the low-flow cut-off value.

UR.3. Use of Device.

UR.3.1. Unit Price and Product Identity for Retail Dispensers. – The unit price at which the dispenser is set to compute shall be conspicuously displayed or posted on the face of a retail dispenser used in direct sale.

UR.3.2. Vehicle-mounted Measuring Systems Ticket Printer.

UR.3.2.1. Customer Ticket. – Vehicle-mounted measuring systems shall be equipped with a ticket printer which shall be used for all sales where product is delivered through the device. A copy of the ticket issued by the device shall be left with the customer at the time of delivery or as otherwise specified by the customer.

UR.3.2.2. Ticket in Printing Device. – A ticket shall not be inserted into a device equipped with a ticket printer until immediately before a delivery is begun, and in no case shall a ticket be in the device when the vehicle is in motion while on a public street, highway, or thoroughfare.

UR.3.3. Printed Ticket. – The total price, the total quantity of the delivery, and the price per unit shall be printed on any ticket issued by a device of the computing type and containing any one of these values.

UR.3.4. Steps After Dispensing. – After delivery to a customer from a retail dispenser:

- (a) the device shall be shut-off at the end of a delivery, through an automatic interlock that prevents a subsequent delivery until the indicating elements and recording elements, if the device is equipped and activated to record, have been returned to their zero positions; and
- (b) the discharge nozzle shall not be returned to its start position unless the zero set-back interlock is engaged or becomes engaged by the act of disconnecting the nozzle or the act of returning the discharge nozzle.

UR.3.5. Return of Indicating and Recording Elements to Zero. – The primary indicating elements (visual), and the primary recording elements shall be returned to zero immediately before each delivery.

UR.3.6. Return of Product to Storage, Retail Hydrogen Gas Dispensers. – Provisions at the site shall be made for returning product to storage or disposing of the product in a safe and timely manner during or following testing operations. Such provisions may include return lines, or cylinders adequate in size and number to permit this procedure.

UR.3.7. Conversion Factors. – Established correction values ϵ . (**Also** see references in N.7. Density.) shall be used whenever measured hydrogen gas is billed. All sales shall be based on kilograms.

Appendix D. Definitions

The specific code to which the definition applies is shown in [brackets] at the end of the definition. Definitions for the General Code [1.10] apply to all codes in Handbook 44.

A

audit trail. – An electronic count and/or information record of the changes to the values of the calibration or configuration parameters of a device. [1.10, 2.20, 2.21, 2.24, 3.30, 3.37, 3.39, 5.56(a)]

automatic temperature or density compensation. – The use of integrated or ancillary equipment to obtain from the output of a volumetric meter an equivalent mass, or an equivalent liquid volume at the assigned reference temperature below and a pressure of 14.696 lb/in² absolute.

| | |
|---|----------------------|
| Cryogenic liquids | 21 °C (70 °F) [3.34] |
| Hydrocarbon gas vapor | 15 °C (60 °F) [3.33] |
| Hydrogen gas | 21 °C (70 °F) [3.39] |
| Liquid carbon dioxide | 21 °C (70 °F) [3.38] |
| Liquefied petroleum gas (LPG) and Anhydrous ammonia | 15 °C (60 °F) [3.32] |
| Petroleum liquid fuels and lubricants | 15 °C (60 °F) [3.30] |

C

calibration parameter. – Any adjustable parameter that can affect measurement or performance accuracy and, due to its nature, needs to be updated on an ongoing basis to maintain device accuracy (e.g., span adjustments, linearization factors, and coarse zero adjustments).[2.20, 2.21, 2.24, 3.30, 3.37, 3.39, 5.56(a)]

D

discharge hose. – A flexible hose connected to the discharge outlet of a measuring device or its discharge line.[3.30, 3.31, 3.32, 3.34, 3.37, 3.38, 3.39]

discharge line. – A rigid pipe connected to the outlet of a measuring device.[3.30, 3.31, 3.32, 3.34, 3.37, 3.39]

E

event counter. – A nonresettable counter that increments once each time the mode that permits changes to sealable parameters is entered and one or more changes are made to sealable calibration or configuration parameters of a device.[2.20, 2.21, 3.30, 3.37, 3.39, 5.54, 5.56(a), 5.56(b), 5.57]

event logger. – A form of audit trail containing a series of records where each record contains the number from the event counter corresponding to the change to a sealable parameter, the identification of the parameter that was changed, the time and date when the parameter was changed, and the new value of the parameter.[2.20, 2.21, 3.30, 3.37, 3.39, 5.54, 5.56(a), 5.56(b), 5.57]

I

indicating element. – An element incorporated in a weighing or measuring device by means of which its performance relative to quantity or money value is "read" from the device itself as, for example, an index-and-graduated-scale combination, a weighbeam-and-poise combination, a digital indicator, and the like. (Also see "primary indicating or recording element.") [1.10]

M

minimum measured quantity (MMQ). – The smallest quantity delivered for which the measurement is to within the applicable tolerances for that system.[3.37, 3.39]

N

nonresettable totalizer. – An element interfaced with the measuring or weighing element that indicates the cumulative registration of the measured quantity with no means to return to zero.[3.30, 3.37, 3.39]

P

point-of-sale system. – An assembly of elements including a weighing or measuring element, an indicating element, and a recording element (and may also be equipped with a "scanner") used to complete a direct sales transaction.[2.20, 3.30, 3.32, 3.37, 3.39]

R

remote configuration capability. – The ability to adjust a weighing or measuring device or change its sealable parameters from or through some other device that is not itself necessary to the operation of the weighing or measuring device or is not a permanent part of that device.[2.20, 2.21, 2.24, 3.30, 3.37, 3.39, 5.56(a)]

retail device. – A measuring device primarily used to measure product for the purpose of sale to the end user.[3.30, 3.32, 3.37, 3.39]

W

wet hose. – A discharge hose intended to be full of product at all times. (SeeAlso see "wet-hose type.") [3.30, 3.31, 3.38, 3.39] |

wet-hose type. – A type of device designed to be operated with the discharge hose full of product at all times. (SeeAlso see "wet hose.") [3.30, 3.32, 3.34, 3.37, 3.38, 3.39] |

MARKUP COPY

Section 4.40. Vehicle Tanks Used as Measures

A. Application

A.1. General. – This code applies to vehicle tanks when these are used as commercial measures.

A.2. Exceptions. – This code does not apply to the following devices:

- (a) Devices used solely for dispensing a product in connection with operations in which the amount dispensed does not affect customer charges.
- (b) Meters mounted on vehicle tanks (for which see Section 3.31. Code for Vehicle-Tank Meters).

A.3. Additional Code Requirements. – In addition to the requirements of this code, Vehicle Tanks Used as Measures shall meet the requirements of Section 1.10. General Code.

S. Specifications

S.1. Design of Compartments.

S.1.1. Compartment Distortion. – The shell and bulkheads of a vehicle tank shall be so constructed that under any condition of liquid lading they will not become distorted sufficiently to cause a change in the capacity of any compartment (as determined by volumetric test) equal to more than 0.25 L per 750 L (0.5 pt per 200 gal), or fraction thereof, of the nominal compartment capacity, or to more than 0.5 L (1 pt), whichever is greater. (This specification prescribes a limit on permissible distortion only, and is not to be construed as setting up a secondary tolerance on compartment capacities to be added to the values given in tolerance paragraph T.2. Tolerance Values.)

S.1.2. Venting. – During filling operations, effective venting of a compartment shall be provided to permit air to escape from all spaces designed to be filled with liquid and to permit the influx of air to the compartment during the discharge of liquid therefrom. Venting shall prevent any formation of air pockets.

S.1.3. Completeness of Delivery. – A tank shall be so constructed that, when it is standing on a level surface, complete delivery can be made from any compartment through its delivery faucet or valve whether other compartments are full or empty, and whether or not the delivery is through a manifold.

S.1.4. Fill or Inspection Opening. – The fill or inspection opening of a compartment shall be of such size and location that it can readily be determined by visual inspection that the compartment has been properly filled or completely emptied and shall be so positioned with respect to the ends of the compartment that the indicator may be positioned as required. In no case shall the opening, if circular, have a diameter of less than 20 cm (7⁵/₈ in), or, if other than circular, have an effective area of less than 290 cm² (45 in²).

S.1.5. Dome Flange and Baffle Plates. – Any dome flange extending into a compartment shall be provided with sufficient perforations or openings flush with the compartment shell to prevent any trapping of air. All baffle plates in a compartment shall be so cut away at top and bottom, and elsewhere as necessary, as to facilitate loading and unloading.

S.1.6. Compartment and Piping Capacities and Emergency Valve. – If a compartment is equipped with an emergency (or safety) valve, this shall be positioned at the lowest point of outlet from the compartment, and the compartment capacity or capacities shall be construed as excluding the capacity of the piping leading therefrom. However, the capacity of the piping leading from such a compartment shall be separately determined and reported, and may be separately marked as specified in S.4. Marking of Compartments.

S.1.6.1. On Vehicle Tanks Equipped for Bottom Loading. – On equipment designed for bottom loading, the compartment capacity shall include the piping of a compartment to the valve located on the

upstream side of the manifold and immediately adjacent thereto or, if not manifolded, to the outlet valve, provided that on or immediately adjacent to the marking as specified in S.4. Marking of Compartments the following words or a statement of similar meaning shall be affixed: “Warning: Emergency valves must be opened before checking measurement.”

S.1.7. Expansion Space. – When a compartment is filled to the level of the highest indicator in the compartment, there shall remain an expansion space of at least 0.75 % of the nominal compartment capacity as defined by that indicator.

S.2. Design of Compartment Indicators.

S.2.1. General. – An indicator shall be so designed that it will distinctly and unmistakably define a capacity point of its compartment when liquid is in contact with the lowest portion of the indicator.

S.2.2. Number of Indicators. – In no case shall a compartment be provided with more than five indicators.

(Amended 1972)

S.2.3. Identification of Multiple Indicators. – If a compartment is provided with multiple indicators, each such indicator shall be conspicuously marked with an identifying letter or number.

S.2.4. Location. – An indicator shall be located:

- (a) midway between the sides of its compartment;
- (b) as nearly as practicable midway between the ends of its compartment, and in no case offset by more than 10 % of the compartment space or 15 cm (6 in), whichever is less;
(Amended 1972)
- (c) so that it does not extend into, nor more than 15 cm (6 in) from that section of the compartment defined by a vertical projection of the fill opening;
(Amended 1974)
- (d) at a depth, measuring from the top of the dome opening, not lower than 46 cm (18 in) for fill openings of less than 38 cm (15 in) in diameter, or, if other than circular, an effective area of less than 1130 cm² (175 in²), and not lower than 61 cm (24 in) for larger fill openings; and
- (e) to provide a clearance of not less than 5 cm (2 in) between indicators.

S.2.5. Permanence. – Any indicator that is not intended to remain adjustable and all brackets or supports shall be securely welded in position.

S.2.6. Adjustable Indicators. – Adequate provision shall be made for conveniently affixing a security seal or seals:

- (a) to any indicator intended to remain adjustable, so that no adjustment of the indicator can be made without mutilating or destroying the seal; and
- (b) to any removable part to which an indicator may be attached, so that the part cannot be removed without mutilating or destroying the seal.

S.2.7. Sensitiveness. – The position of any indicator in its compartment shall be such that at the level of the indicator a change of 1.0 mm (0.04 in) in the height of the liquid surface will represent a volume change of not more than the value of the tolerance for the nominal compartment capacity as defined by that indicator.

S.3. Design of Compartment Discharge Manifold. – When two or more compartments discharge through a common manifold or other single outlet, effective means shall be provided to ~~ensure that~~**ensure** that:

- (a) liquid can flow through the delivery line leading from only one compartment at one time and that flow of liquid from one compartment to any other is automatically prevented; or
- (b) all compartments will discharge simultaneously.

If the discharge valves from two or more compartments are automatically controlled so that they can only be operated together, thus effectively connecting these compartments to one another, such compartments shall, for purposes of this paragraph, be construed to be one compartment.

S.4. Marking of Compartments.

S.4.1. Compartment Identification. – Each compartment of a multiple-compartment tank shall be conspicuously identified by a letter or number marked on the dome or immediately below the fill opening. Such letters or numbers shall be in regular sequence from front to rear, and the delivery faucets or valves shall be marked to correspond with their respective compartments.

S.4.2. Compartment Capacity, Single Indicator. – A compartment provided with a single indicator shall be clearly, permanently, and conspicuously marked with a statement of its capacity as defined by its indicator.

S.4.3. Compartment Capacity, Multiple Indicators. – A compartment provided with two or more indicators shall be clearly, permanently, and conspicuously marked with a statement identifying:

- (a) each indicator by a letter or number; and
- (b) immediately adjacent to each letter or number, the capacity of the compartment as defined by the particular indicator.

N. Notes

N.1. Test Liquid. – Water or light fuel oil shall be used as the test liquid for a vehicle-tank compartment.

N.2. Evaporation and Volume Change. – Care shall be exercised to reduce to a minimum, evaporation losses and volume changes resulting from changes in temperature of the test liquid.

N.3. To Deliver. – A vehicle-tank compartment shall be gauged “to deliver.” If the compartment is gauged by measuring the test liquid into the tank, the inside tank walls shall first be thoroughly wetted.

N.4. Gauging of Compartments. – When a compartment is gauged to determine the proper position for an indicator or to determine what a capacity marking should be, whether on a new vehicle tank or following repairs or modifications that might affect compartment capacities, tolerances are not applicable, and the indicator shall be set and the compartment capacity shall be marked as accurately as practicable.

N.5. Adjustment and Remarking. – When a compartment is found upon test to have an error in excess of the applicable tolerance, the capacity of the compartment shall be adjusted to agree with its marked capacity, or its marked capacity shall be changed to agree with its capacity as determined by the test.

T. Tolerances

T.1. Application.

T.1.1. To Excess and to Deficiency. – The tolerances hereinafter prescribed shall be applied to errors in excess and in deficiency.

T.2. Tolerance Values. – Maintenance and acceptance tolerances shall be as shown in Table 1. Maintenance and Acceptance Tolerances on Vehicle-Tank Compartments.

| Table 1. Maintenance and Acceptance Tolerances on Vehicle-Tank Compartments | | |
|--|---|---|
| Nominal Capacity of Compartment | Maintenance and Acceptance Tolerances | |
| | Expressed in Quarts | Expressed in Gallons |
| Gallons 200 or less | 2 | 0.5 |
| 201 to 400, inclusive | 3 | 0.75 |
| 401 to 600, inclusive | 4 | 1.0 |
| 601 to 800, inclusive | 5 | 1.25 |
| 801 to 1000, inclusive | 6 | 1.50 |
| over 1000 | Add 1 quart per 200 gallons or fraction thereof | Add 0.25 gallon per 200 gallons or fraction thereof |

UR. User Requirements

UR.1. Conditions of Use.

UR.1.1. Filling. – A vehicle shall stand upon a level surface during the filling of a compartment.

UR.1.2. Delivering. – During a delivery, a vehicle shall be so positioned as to assure complete emptying of a compartment. Each compartment shall be used for an individual delivery only; that is, an individual delivery shall consist of the entire contents of a compartment or compartments.

(Amended 1976)

Section 4.41. Liquid Measures

A. Application

A.1. General. – This code applies to liquid measures; that is, to rigid measures of capacity designed for general and repeated use in the measurement of liquids.

A.2. Exceptions. – The code does not apply to test measures or other volumetric standards.

A.3. Additional Code Requirements. – In addition to the requirements of this code, Liquid Measures shall meet the requirements of Section 1.10. General Code.

S. Specifications

S.1. Units.

- (a) The capacity of a liquid measure shall be 0.1 L, 0.2 L, 0.5 L, 1 L, 2 L, 5 L, or a multiple of 5 L, and the measure shall not be subdivided.
- (b) The capacity of a liquid measure shall be 1 gill, ½ liq pt, 1 liq pt, 1 liq qt, ½ gal, ¼ gal, 1½ gal, or a multiple of 1 gal, and the measure shall not be subdivided. However, 3 pt and 5 pt brick molds and 2½ gal (10 qt) cans shall be permitted when used exclusively for ice cream.

S.2. Material. – Measures shall be made of metal, glass, earthenware, enameled ware, composition, or similar and suitable material. If made of metal, the thickness of the metal shall not be less than the appropriate value given in Table 1. Minimum Thickness of Metal for Liquid Measures.

| Table 1. | | |
|---|--|--|
| Minimum Thickness of Metal for Liquid Measures | | |
| Nominal Capacity | Minimum Thickness | |
| | For Iron or Steel, Plated, or Unplated (inch) | For Copper or Aluminum (inch) |
| 1 pint or less | 0.010 | 0.020 |
| 1 quart, ½ gallon, 1 gallon | 0.014 | 0.028 |
| Over 1 gallon | 0.016 | 0.032 |

S.3. Capacity Point. – The capacity of a measure shall be determined to a definite edge, or to the lowest portion of a plate, bar, or wire, at or near the top of the measure, and shall not include the capacity of any lip or rim that may be provided.

S.4. Reinforcing Rings. – Reinforcing rings, if used, shall be attached to the outside of the measure and shall show no divisions or lines on the inside surface of the measure.

S.5. Discharge. – A measure equipped with a discharge faucet or valve shall be susceptible to complete discharge through the faucet or valve when the measure is standing on a level surface.

S.6. Marking Requirements. – A measure shall be marked on its side with a statement of its capacity. If the capacity is stated in terms of the pint or quart, the word “Liquid” or the abbreviation “Liq” shall be included.

T. Tolerances

T.1. – Maintenance tolerances in excess and in deficiency shall be as shown in Table 2. Maintenance Tolerances, in Excess and in Deficiency, for Liquid Measures. Acceptance tolerances shall be one-half the maintenance tolerances.

| Table 2. | | | | |
|---|---------------------|---------------------|----------------------|---------------------|
| Maintenance Tolerances, in Excess and in Deficiency, for Liquid Measures | | | | |
| Nominal Capacity | Tolerance | | | |
| | In Excess | | In Deficiency | |
| | fluid drams | cubic inches | fluid drams | cubic inches |
| ½ pt or less | 2.0 | 0.4 | 1.0 | 0.2 |
| 1 pt | 3.0 | 0.7 | 1.5 | 0.3 |
| 1 qt | 4.0 | 0.9 | 2.0 | 0.5 |
| ½ gal | 6.0 | 1.4 | 3.0 | 0.7 |
| | fluid ounces | cubic inches | fluid drams | cubic inches |
| 1 and ¼ gal | 1.0 | 1.8 | 4.0 | 0.9 |
| 1½ gal | 1.5 | 2.7 | 6.0 | 1.4 |
| | fluid ounces | cubic inches | fluid ounces | cubic inches |
| 2 gal | 2.0 | 3.5 | 1.0 | 1.8 |
| 3 and 4 gal | 4.0 | 7.0 | 2.0 | 3.6 |
| 5 gal | 6.0 | 11.0 | 3.0 | 5.4 |
| 10 gal | 10.0 | 18.0 | 5.0 | 9.0 |

Section 4.42. Farm Milk Tanks

A. Application

A.1. General. – This code applies to farm milk tanks on the premises of producers when these are used, or are to be used, for the commercial measurement of milk.

A.2. Exceptions. – This code does not apply to tanks mounted on highway vehicles.

A.3. Additional Code Requirements. – In addition to the requirements of this code, Farm Milk Tanks shall meet the requirements of Section 1.10. General Code.

S. Specifications

S.1. Components. – A farm milk tank, whether stationary or portable, shall be considered suitable for commercial use only when it comprises:

- (a) a vessel, whether or not it is equipped with means for cooling its contents;
- (b) a means for reading the level of liquid in the tank, such as a removable gauge rod or surface gauge; and
- (c) a chart for converting level-of-liquid readings to volume.

Each compartment of a subdivided tank shall, for the purposes of this code, be construed to be a farm milk tank.

S.2. Design of Tank.

S.2.1. Level. – A farm milk tank shall be designed to be in normal operating position when it is in level. The tank shall be so constructed that it will maintain its condition of level under all normal conditions of lading.

S.2.2. Level-Indicating Means. – A tank shall be permanently equipped with sensitive means by which the level of the tank can be determined.

S.2.2.1. On a Stationary Tank. – A stationary tank shall be provided with such level-indicating means as a two-way or circular level, a plumb bob, two-way leveling lugs, or the like; or the top edge or edges of the tank shall be so constructed throughout as to provide an accurate reference for level determinations; provided, that when leveling lugs or the top edge or edges of the tank are used as the reference for level determinations, there shall be supplied with the tank a sensitive spirit level of appropriate dimensions, and the positions where such level is intended to be used shall be permanently marked on the reference surface of the tank; and provided further, that when leveling lugs are used they shall be so designed, constructed, and installed at the factory that any alteration of the original position or condition, such as by hammering or filing, would be difficult and would become obvious. A stationary tank with a nominal capacity of 2 000 L or 500 gal, or greater shall be provided with at least two similar level-indicating means, and these shall be located in opposite and distant positions from each other to facilitate an accurate level determination in both directions of the tank's horizontal plane.

(Amended 1980)

S.2.2.2. On a Portable Tank. – A portable tank shall be provided with either a two-way or a circular level.

S.2.3. Portable Tank. – A portable tank shall be of the center-reading type; that is, it shall be so designed that the gauge rod or surface gauge, when properly positioned for use, will be approximately in the vertical axis of the tank, centrally positioned with respect to the tank walls.

S.2.4. Capacity. – *A farm milk tank shall be clearly and permanently marked on a surface visible after installation with its capacity as determined by the manufacturer. The capacity shall not exceed an amount that can be agitated without overflowing and that can be measured accurately with the liquid at rest.*
[Nonretroactive as of January 1, 1979]

S.3. Design of Indicating Means.

S.3.1. General. – *A tank shall include indicating means and shall be calibrated over the entire range of the volume of the tank from 5 % of capacity or 2 m³ (500 gal) whichever is less, to its maximum capacity.*
[Nonretroactive as of January 1, 1986]
(Added 1985)

S.3.2. Gauge-Rod Bracket or Supports. – If a tank is designed for use with a gauge rod, a substantial and rigid gauge-rod bracket or other suitable supporting elements for positioning the gauge rod shall be provided. A gauge rod and its brackets or other supporting elements shall be so constructed that, whenever the rod is placed in engagement with the bracket or supports and released, the rod will automatically seat itself at a fixed height and in a vertical position. When a gauge rod is properly seated on its brackets or supports, there shall be a clearance of at least 7.5 cm (3 in) between the graduated face of the rod and any tank wall or other surface that it faces.

S.3.3. Gauge Rod. – When properly seated in position, a rod shall not touch the bottom of the tank unless this is required by the design of the supporting elements. The rod shall be graduated throughout an interval corresponding to the volume range within which readings of liquid level are to be made.

S.3.4. Surface-Gauge Bracket or Supports. – If a tank is designed for use with a surface gauge, a substantial and rigid surface-gauge bracket or other suitable supporting elements for positioning the surface gauge shall be provided. A surface gauge and its brackets or other supporting elements shall be so constructed that, whenever the gauge assembly is placed in engagement with the bracket or supports, the indicator, if not permanently mounted on the tank, will automatically seat itself in correct operating position, and the graduated element will be vertically positioned and will be securely held at any height to which it may be manually set.

S.3.5. Surface Gauge. – When properly engaged with its bracket and set to its lowest position, a surface gauge shall not touch the bottom of the tank. The gauge shall be graduated throughout an interval corresponding to the volume range within which readings of liquid level are to be made.

S.3.6. External Gauge Assemblies.

S.3.6.1. Design and Installation. – The gauge assembly shall be designed to meet sanitary requirements and shall be readily accessible for cleaning purposes. The gauge assembly shall be mounted in a vertical position and equipped with a sliding mechanism to assist in determining the liquid level.

S.3.6.2. Gauge Tube. – The gauge tube shall be borosilicate glass or approved rigid plastic or rigidly supported flexible tubing with a uniform internal diameter not less than 2 cm (¾ in). It shall be designed and constructed so that all product in the gauge can be discarded in such a manner that no product in the gauge tube will enter the discharge line or tank.
(Amended 1983)

S.3.6.3. Scale Plate. – The scale plate shall be mounted adjacent to and parallel with the gauge tube and be no more than 7 mm (¼ in) from the tube.

S.3.6.4. Scale Graduations. – The graduation lines shall be clear and easily readable and shall comply with the requirements of paragraphs included under S.3.7. Graduations.

S.3.6.5. Venting. – An external gauge tube shall be adequately vented at the top, open to the atmosphere. Any attachment to the gauge tube shall not adversely affect the operation of this vent.

(Added 1984)

(Added 1977)

S.3.7. Graduations.

S.3.7.1. Spacing and Width of Graduations. – On a gauge rod or surface gauge, the spacing of the graduations, center to center, shall be not more than 1.6 mm (0.0625 in or $\frac{1}{16}$ in) and shall not be less than 0.8 mm (0.03125 in or $\frac{1}{32}$ in). The graduations shall not be less than 0.12 mm (0.005 in) in width, and the clear interval between adjacent edges of successive graduations shall be not less than 0.4 mm (0.015625 in or $\frac{1}{64}$ in).

S.3.7.2. Values of Graduations. – On a gauge rod or surface gauge, the graduations may be designated in inches or in centimeters and fractions thereof, or may be identified in a numerical series without reference to inches or centimeters or fractions thereof. In either case, a volume chart shall be provided for each such rod or gauge and each tank with which it is associated, showing values in terms of the graduation on the rod or gauge. If a rod or gauge is associated with but one tank, in lieu of linear or numerical series graduations and volume chart, values in terms of volume of liquid in the tank may be shown directly on the rod or gauge.

S.3.7.3. Value of Graduated Interval. – The value of a graduated interval on a gauge rod or surface gauge (exclusive on the interval from the bottom of the tank to the lowest graduation) shall not exceed:

- (a) 2 L for a tank of a nominal capacity of 1000 L or less; $\frac{1}{2}$ gal for a tank of a nominal capacity of 250 gal or less;
- (b) 4 L for a tank of a nominal capacity of 1001 L to 2000 L, inclusive; 1 gal for a tank of a nominal capacity of 251 gal to 500 gal, inclusive;
- (c) 6 L for a tank of a nominal capacity of 2001 L to 6000 L, inclusive; $1\frac{1}{2}$ gal for a tank of a nominal capacity of 501 gal to 1500 gal, inclusive;
- (d) 8 L for a tank of a nominal capacity of 6001 L to 10 000 L, inclusive; 2 gal for a tank of a nominal capacity of 1501 gal to 2500 gal, inclusive; or
- (e) 8 L plus 4 L for each additional 10 000 L or fraction thereof, for tanks of nominal capacity above 10 000 L or 2 gal plus 1 gal for each additional 2500 gal or fraction thereof, for tanks with nominal capacity above 2500 gal.

(Amended 1980)

S.3.8. Design of Indicating Means on Tanks with a Capacity Greater than 8000 Liters or 2000 Gallons. – Any farm milk tank with a capacity greater than 8000 L, or 2000 gal, shall be equipped with an external gauge assembly.

[Nonretroactive and applicable only to tanks manufactured after January 1, 1981]

(Added 1980)

S.4. Design of Volume Chart.

S.4.1. General. – A volume chart shall show volume values only, *over the entire range of the volume of the tank from 5 % of capacity or 2 m³ (500 gal) whichever is less, to its maximum capacity.** All letters and figures on the chart shall be distinct and easily readable. The chart shall be substantially constructed, and the face of the chart shall be so protected that its lettering and figures will not tend easily to become obliterated or illegible.

[*Nonretroactive as of January 1, 1986]

(Amended 1985)

S.4.2. For a Tank of 1 000 Liters, or 250 Gallons, or Less. – The volume chart for a tank of nominal capacity of 1 000 L, or 250 gal, or less shall show values at least to the nearest 1 L, or ¼ gal.

S.4.3. For a Tank of 1 001 Liters to 2000 Liters, or 251 to 500 Gallons. – The volume chart for a tank of nominal capacity of 1 001 L to 2 000 L, or 251 gal to 500 gal, inclusive, shall show values at least to the nearest 2 L, or ½ gal.

S.4.4. For a Tank of Greater than 2 000 Liters, or 500 Gallons. – The volume chart for a tank of nominal capacity of greater than 2 000 L, or 500 gal, shall show values at least to the nearest gallon, or 4 L.

(Amended 1980)

S.5. Gauging.

S.5.1. Level. – A farm milk tank shall be level, as shown by the level-indicating means, during the original gauging operation.

S.5.2. To Deliver. – A farm milk tank shall be originally gauged “to deliver.” If the tank is gauged by measuring the test liquid into the tank, the inside tank walls shall first be thoroughly wetted and the tank shall then be drained for 30 seconds after the main drainage flow has ceased.

S.5.3. Preparation of Volume Chart. – When a tank is gauged for the purposes of preparing a volume chart, tolerances are not applicable, and the chart shall be prepared as accurately as practicable.

S.6. Identification. – A tank and any gauge rod, surface gauge, spirit level, and volume chart intended to be used therewith shall be mutually identified, as by a common serial number, in a prominent and permanent manner.

N. Notes

N.1. Test Liquid. – Water shall be used as the test liquid for a farm milk tank.

N.2. Evaporation and Volume Change. – Care shall be exercised to reduce to a minimum, evaporation losses and volume changes resulting from changes in temperature of the test liquid.

N.3. To Deliver. – A farm milk tank shall be tested “to deliver.” If the tank is gauged by measuring the test liquid delivered into the tank, the inside tank walls shall first be thoroughly wetted and the tank then shall be drained for 30 seconds after the main drainage flow has ceased.

N.4. Level. – A farm milk tank shall be level, as shown by the level-indicating means, during gauging and testing.

N.5. Test Methods. – Acceptance tests of milk tanks may be of either the prover method or the master meter method provided that the master metering system is capable of operating within 25 % of the applicable tolerance found in T.3. Basic Tolerance Values. Subsequent tests may be of either the prover method or the master meter method provided that the master metering system is capable of operating within 25 % of the applicable tolerance found in T.4. Basic Tolerance Values, Master Meter Method.

N.5.1. Verification of Master Metering Systems. – A master metering system used to gauge a milk tank shall be verified before and after the gauging process. A master metering system used to calibrate a milk tank shall be verified before starting the calibration and re-verified at least every quarter of the tank capacity, or every 2000 L (500 gal), whichever is greater. The above process of re-verifying the master metering system may be waived if the system is verified using a NIST traceable prover with a minimum of two tests immediately before and one test immediately after the gauging process and that each test result is within 25 % of T.3. Basic Tolerance Values.

(Added 2001) (Amended 2012)

N.5.2. Temperature Changes in Water Supply. – When using a master metering system to gauge or calibrate a milk tank, the official shall monitor the temperature of the water before and after changing sources of supply. If the water temperature of the new source changes by more than 2.8 °C (5 °F) from the previous supply, the official shall re-verify the accuracy of the master metering system as soon as possible after the system reaches temperature equilibrium with the new supply source.

(Added 2001)

N.6. Reading the Meniscus. – When a reading or setting is to be obtained from a meniscus formed by milk or other opaque liquid, the index or reading line is the position of the highest point of the center of the meniscus. When calibrating a device with water and the device is to be used with an opaque liquid, the reading should be obtained accordingly; that is, the position of the highest point of the center of the meniscus.

(Added 1984)

T. Tolerances

T.1. Application. – The tolerances hereinafter prescribed shall be applied equally to errors in excess and errors in deficiency.

T.2. Minimum Tolerance Values. – On a particular tank, the maintenance and acceptance tolerance applied shall be not smaller than the volume corresponding to the graduated interval at the point of test draft on the indicating means or 2 L (½ gal), whichever is greater.

(Amended 1980)

T.3. Basic Tolerance Values. – The basic maintenance and acceptance tolerance shall be 0.2 % of the volume of test liquid in the tank at each test draft.

(Amended 1975)

T.4. Basic Tolerance Values, Master Meter Method. – The basic maintenance and acceptance tolerance for tanks tested by the master meter method shall be 0.4 % of the volume of test liquid in the tank at each test draft.

(Added 1975)

UR. User Requirements

UR.1. Installation. – A stationary tank shall be rigidly installed in level without the use of removable blocks or shims under the legs. If such tank is not mounted permanently in position, the correct position on the floor for each leg shall be clearly and permanently defined.

UR.2. Level Condition.

UR.2.1. Stationary Tank. – A stationary farm milk tank shall be maintained in level.

UR.2.1.1. Leveling Lugs. – If leveling lugs are provided on a stationary tank, such lugs shall not be hammered or filed to establish or change a level condition of the tank.

UR.2.2. Portable Tank. – On a portable tank, measurement readings shall be made only when the tank is approximately level; that is, when it is not out of level by more than 5 % or approximately three degrees in any direction.

UR.3. Weight Chart. – An auxiliary weight chart may be provided, on which shall be prominently displayed the weight per unit volume value used to derive the weight values from the official volume chart.

UR.4. Use. – A farm milk tank shall not be used to measure quantities greater than an amount that can be agitated without overflowing.

MARKUP COPY

THIS PAGE INTENTIONALLY LEFT BLANK

MARKUP COPY

Section 4.43. Measure-Containers

A. Application

A.1. General. – This code applies to measure-containers, including lids or closures if such are necessary to provide total enclosure of the measured commodity, as follows:

- (a) Retail measure-containers intended to be used only once to determine at the time of retail sale, and from bulk supply, the quantity of commodity on the basis of liquid measure. The retail measure-container serves as the container for the delivery of the commodity.
- (b) Prepackaged measure-containers intended to be used only once to determine in advance of sale the quantity of a commodity (such as ice cream, ice milk, or sherbet) on the basis of liquid measure. The prepackaged measure-container serves as the container for the delivery of the commodity, in either a wholesale or a retail marketing unit.

A.2. Exceptions. – This code does not apply to rigid containers used for milk, cream, or other fluid dairy products, which are covered by packaging requirements.

A.3. Additional Code Requirements. – In addition to the requirements of this code, Measure-Containers shall meet the requirements of Section 1.10. General Code.

S. Specifications

S.1. Units. – The capacity of a measure-container shall be a multiple of or a binary submultiple of a quart or a liter, and the measure shall not be subdivided. However, for prepackaged measure-containers, any capacity less than $\frac{1}{4}$ L or $\frac{1}{2}$ liq pt shall be permitted.

(Amended 1979)

S.2. Capacity Point. – The capacity of a measure-container shall be sharply defined by:

- (a) the top edge;
- (b) a line near the top edge; or
- (c) the horizontal cross-sectional plane established by the bottom surface of the removable lid or cap when seated in the container.

S.3. Shape. – A measure-container shall be designed as some suitable geometrical shape, and its capacity shall be determined without distortion from its normal assembled shape.

S.4. Marking.

S.4.1. Capacity Point. – If the capacity point of a measure-container is defined by a line, the container shall be marked conspicuously on its side with a suitable statement clearly identifying this line as the capacity point.

S.4.2. Capacity Statement. – A measure-container shall be clearly and conspicuously marked with a statement of its capacity in terms of one of the units prescribed in Section S.1. Units.

N. Notes

N.1. Test Liquid. – Water shall be used as the test liquid for a measure-container.

N.2. Preparation of Container for Test.

N.2.1. General. – Before an actual test is begun, a measure-container shall, if necessary, be so restrained that it will maintain its normal assembled shape and that its sides will not bulge when it is filled with water.

N.2.2. Restraining Form for Test.

N.2.2.1. For Rectangular Containers of One Liter, One Quarter Less. – Bulging of the sides of a rectangular measure-container of 1 L (1 qt) capacity or less may be controlled by holding against each side of the container, with a cord, rubber bands, or tape, a metal plate or a piece of heavy cardboard slightly smaller than the side of the container.

(Amended 1979)

N.2.2.2. For Rectangular Prepackaged Measure-container of Two Quarts or Two Liters or Greater. – A rectangular prepackaged measure-container of 2 L (2 qt) capacity or greater shall be supported during a test by a rigid restraining form. This form shall restrain not less than the entire area of the central two-thirds of each side of the container, measured from bottom to top. The inside width dimension of any side panel of the restraining form shall be 1.6 mm ($1/16$ in) greater than the corresponding outside dimension of the container. (The outside width dimension of any side panel of the container shall be established by adding to the inner side center-of-score to center-of-score dimension two thicknesses of the board used, and the sum thus obtained shall be rounded off to the nearest 0.4 mm ($1/64$ in).)

(Amended 1979)

T. Tolerances

T.1. Tolerances on an Individual Measure. – The acceptance tolerances in excess and in deficiency on an individual measure shall be as shown in Table 1. Acceptance Tolerances, in Excess and in Deficiency, for Measure-Containers.

T.2. Tolerance on Average Capacity. – The average capacity on a random sample of 10 measures selected from a lot of 25 or more shall be equal to or greater than the nominal capacity.

(Amended 1979)

UR. User Requirements

UR.1. Limitation of Use. – The use of a measure-container with a rectangular cross section of a capacity of 2 L (2 qt) or greater shall be limited to the packaging, in advance of sale, of ice cream, sherbet, or other similar frozen desserts.

(Amended 1979)

| Table 1. | | | | |
|---|---------------------------------|---------------------------------|----------------------------------|----------------------------------|
| Acceptance Tolerances, in Excess and in Deficiency, for Measure-Containers | | | | |
| Nominal Capacity | Tolerance | | | |
| | In Excess | | In Deficiency | |
| | milliliters | | milliliters | |
| ¼ liter or less | 10 | | 5.0 | |
| ½ liter | 15 | | 7.5 | |
| 1 liter | 20 | | 10.0 | |
| Over 1 liter | Add per liter 10 milliliters | | Add per liter 5.0 milliliters | |
| | fluid drams | cubic inches | fluid drams | cubic inches |
| ½ pint or less | 3 | 0.6 | 1.5 | 0.3 |
| 1 pint | 4 | 1.0 | 2.0 | 0.5 |
| 1 quart | 6 | 1.4 | 3.0 | 0.7 |
| 2 quarts | 9 | 2.0 | 4.5 | 1.0 |
| 3 quarts | 10 | 2.4 | 5.0 | 1.2 |
| 4 quarts | 12 | 2.8 | 6.0 | 1.2 |
| Over 4 quarts | Add per quart 3 fluid drams | Add per quart 0.7 cubic inch | Add per quart 1.5 fluid drams | Add per quart 0.35 cubic inch |

THIS PAGE INTENTIONALLY LEFT BLANK

MARKUP COPY

Section 4.44. Graduates

A. Application

A.1. General. – This code applies to subdivided glass measures of capacity, either cylindrical or conical in shape.

A.2. Additional Code Requirements. – In addition to the requirements of this code, Graduates shall meet the requirements of Section 1.10. General Code.

S. Specifications

S.1. Units. – Nominal capacities, graduation ranges, values of graduated intervals, and numbered graduations applicable to single-scale graduates and to the appropriate portions of double scale graduates shall be as shown in Table 1. Design Details for Graduates.

| Nominal Capacity | To be Graduated Between | | Value of Graduated Intervals | Number at Each Graduation Divisible by |
|--|-------------------------|------|------------------------------|--|
| milliliters | milliliters | | milliliters | milliliters |
| 5 | 1 and | 5 | $\frac{1}{2}$ | 1 |
| 10 | 2 and | 10 | 1 | 2 |
| 25 | 5 and | 25 | 5 | 5 |
| 50 | 10 and | 50 | 5 | 10 |
| 100 | 20 and | 100 | 10 | 20 |
| 500 | 100 and | 500 | 25 | 50 |
| 1000 | 200 and | 1000 | 50 | 100 |
| minims | Minims | | minims | minims |
| 60 | 15 and | 60 | 5 | 10 ^a |
| 120 | 30 and | 120 | 10 | 20 ^b |
| fluid drams | fluid drams | | fluid drams | fluid drams |
| 4 | 1 and | 4 | $\frac{1}{2}$ | 1 |
| 8 | 2 and | 8 | 1 | 2 |
| fluid ounces | fluid ounces | | fluid ounces | fluid ounces |
| 2 | $\frac{1}{2}$ and | 2 | $\frac{1}{4}$ | $\frac{1}{2}$ |
| 4 | 1 and | 4 | $\frac{1}{2}$ | 1 |
| 8 | 2 and | 8 | $\frac{1}{2}$ | 1 |
| 16 | 4 and | 16 | 1 | 2 |
| 32 | 8 and | 32 | 2 | 4 |
| ^a And, in addition, at the first (15-minim) graduation. ^b And, in addition, at the first (30-minim) graduation. | | | | |

S.2. Initial Interval. – A graduate shall have an initial interval that is not subdivided, equal to not less than one-fifth and not more than one-fourth of the capacity of the graduate.

S.3. Shape. – A graduate of a capacity of more than 15 mL (4 fl dr) may be of either the cylindrical or circular conical type. A graduate of a capacity of 15 mL (4 fl dr) or less shall be of the single-scale cylindrical type.

S.4. Material. – A graduate shall be made of good-quality, thoroughly annealed, clear, transparent glass, free from bubbles and streaks that might affect the accuracy of measurement. The glass shall be uniform in thickness and shall not be excessively thick.

S.5. Dimensional Proportions.

S.5.1. On a Circular Conical Graduate. – The inside measurement from the bottom of a circular conical graduate to the capacity graduation shall be not less than two times the inside diameter at the capacity graduation. The inside measurement from the bottom of the graduate to the point representing one-fourth of the capacity shall be not less than the inside diameter at that point.

S.5.2. On a Cylindrical Graduate. – The inside measurement from the bottom of a cylindrical graduate to the capacity graduation shall be not less than five times the inside diameter at the capacity graduation.

S.6. Base. – The base of the graduate shall be perpendicular to the vertical axis of the graduate. The diameter of the base shall be of such size that the empty graduate will remain standing on an inclined surface of 25 %, or approximately 15 degrees, from the horizontal.

S.7. Design of Graduations.

S.7.1. General. – Graduations shall be perpendicular to the vertical axis of the graduate and parallel to each other. Graduations shall be continuous, of uniform thickness not greater than 0.4 mm (0.015 in), clearly visible, permanent, and indelible under normal conditions of use.
(Amended 1977)

S.7.2. On a Single-Scale Graduate. – On a single-scale graduate, the main graduations shall completely encircle the graduate and subordinate graduations shall extend at least one-half the distance around the graduate.

S.7.3. On a Double-Scale or a Duplex Graduate. – On a double-scale or duplex graduate, there shall be a clear space between the ends of the main graduations on the two scales, and this space shall be approximately 90 degrees from the lip of the graduate and shall conform to the requirements of Table 2. Clear Space Between Ends of Main Graduations on Double Scale Graduates.

| Table 2. Clear Space Between Ends of Main Graduations on Double Scale Graduates | |
|--|--|
| Inside Diameter of Graduate at the Graduations (inches) | Clear Space Between Ends of Main Graduations (inch) |
| Less than 1.5 | $\frac{1}{8}$ to $\frac{1}{4}$ |
| 1.5 to 3, inclusive | $\frac{1}{4}$ to $\frac{1}{2}$ |
| Over 3 | $\frac{3}{8}$ to $\frac{5}{8}$ |

S.8. Basis of Graduation. – A graduate shall be graduated “to deliver” when the temperature of the graduate is 20 °C (68 °F), and shall be marked accordingly in a permanent and conspicuous manner.

S.9. Marking Requirements. – Each main graduation shall be marked to show its value. Intermediate graduations shall not be marked. Value figures shall be uniformly positioned either directly upon or immediately above the graduations to which they refer. Figures placed upon graduations shall be set in from the ends of the graduations a sufficient distance to allow the ends of the graduations to be used in making a setting.

N. Notes

N.1. Test Liquid. – Water shall be used as the test liquid for graduates.

N.2. Temperature Control. – During the test of a graduate, appropriate precautions shall be exercised to reduce any detrimental temperature effects to the practicable minimum.

T. Tolerances

T.1. – Maintenance and acceptance tolerances in excess and in deficiency shall be as shown in Table 3. Maintenance and Acceptance Tolerances, in Excess and Deficiency, for Graduates for graduates that are graduated “to contain” or “to deliver.” (The tolerance to be applied at any graduation is determined by the inside diameter of the graduate at the graduation in question.)

| <p align="center">Table 3. Maintenance and Acceptance Tolerances, in Excess and in Deficiency, for Graduates</p> | | | | | |
|---|---|--|--|---|--|
| <p align="center">Inside Diameter of Graduate</p> | | <p align="center">Tolerance</p> | <p align="center">Inside Diameter of Graduate</p> | | <p align="center">Tolerance</p> |
| <p align="center">From</p> | <p align="center">To But Not Including</p> | | <p align="center">From</p> | <p align="center">To But Not Including</p> | |
| <p align="center">millimeters</p> | | <p align="center">milliliters</p> | <p align="center">inches</p> | | <p align="center">minims</p> |
| 0 | 16 | 0.1 | 0 | ⁹ / ₁₆ | 2 |
| 16 | 21 | 0.2 | ⁹ / ₁₆ | ¹³ / ₁₆ | 3 |
| 21 | 26 | 0.4 | ¹³ / ₁₆ | 1 ¹ / ₁₆ | 6 |
| 26 | 31 | 0.6 | 1 ¹ / ₁₆ | 1 ⁵ / ₁₆ | 10 |
| 31 | 36 | 0.8 | 1 ⁵ / ₁₆ | 1 ⁹ / ₁₆ | 15 |
| 36 | 41 | 1.1 | 1 ⁹ / ₁₆ | 1 ¹³ / ₁₆ | 20 |
| 41 | 46 | 1.4 | 1 ¹³ / ₁₆ | 2 ¹ / ₁₆ | 30 |
| 46 | 51 | 1.8 | 2 ¹ / ₁₆ | 2 ⁵ / ₁₆ | 40 |
| 51 | 56 | 2.2 | 2 ⁵ / ₁₆ | 2 ⁹ / ₁₆ | 50 |
| 56 | 61 | 2.8 | 2 ⁹ / ₁₆ | 2 ¹³ / ₁₆ | 65 |
| 61 | 66 | 3.4 | 2 ¹³ / ₁₆ | 3 ¹ / ₁₆ | 80 |
| 66 | 71 | 4.1 | 3 ¹ / ₁₆ | 3 ⁵ / ₁₆ | 95 |
| 71 | 76 | 4.8 | 3 ⁵ / ₁₆ | 3 ⁹ / ₁₆ | 110 |
| 76 | 81 | 5.6 | 3 ⁹ / ₁₆ | 3 ¹³ / ₁₆ | 130 |
| 81 | 86 | 6.4 | 3 ¹³ / ₁₆ | 4 ¹ / ₁₆ | 150 |
| 86 | 91 | 7.2 | | | |
| 91 | 96 | 8.1 | | | |
| 96 | 101 | 9.0 | | | |

(Amended 1974)

THIS PAGE INTENTIONALLY LEFT BLANK

MARKUP COPY

Section 4.45. Dry Measures

A. Application

A.1. General. – This code applies to rigid measures of capacity designed for general and repeated use in the measurement of solids, including the capacities of ½ bu or more.

A.2. Exceptions.

- (a) This code does not apply to “standard containers” used for the measurement of fruits and vegetables and as shipping containers thereof.
- (b) This code does not apply to berry baskets and boxes ~~(Also see Section 4.46. Code for Berry Baskets and Boxes).~~
(Added 1976)

A.3. Additional Code Requirements. – In addition to the requirements of this code, Dry Measures shall meet the requirements of Section 1.10. General Code.

S. Specifications

S.1. Units. – The capacity of a measure shall be 1 bu, a multiple of the bushel, or a binary submultiple of the bushel, and the measure shall not be subdivided or double-ended.

S.2. Material. – A dry measure shall be made of any suitable material that will retain its shape during normal usage.

S.3. Shape. – A measure, other than a basket, of a capacity of ½ bu or less, shall be cylindrical or conical in shape. The top diameter shall in no case be less than the appropriate minimum diameter shown in Table 1. Minimum Top Diameters for Dry Measure other than Baskets. The bottom of a measure, other than a basket, shall be perpendicular to the vertical axis of the measure and shall be flat, except that a metal bottom may be slightly corrugated. The bottom of a measure shall not be adjustable or movable.

| Table 1. Minimum Top Diameters for Dry Measures other than Baskets | |
|---|------------------------------------|
| Nominal Capacity | Minimum Top Diameter Inches |
| 1 pint | 4 |
| 1 quart | 5 ³ / ₈ |
| 2 quarts | 6 ⁵ / ₈ |
| ½ peck | 8½ |
| 1 peck | 10 ⁷ / ₈ |
| ½ bushel | 13¾ |

S.3.1. Conical Dry Measure. – If conical, the top diameter shall exceed the bottom diameter by not more than 10 % of the bottom diameter.

S.4. Capacity Point. – The capacity of a measure shall be determined by the top edge of the measure.

S.5. Top Reinforcement. – The top edge of a measure shall be reinforced. On a wooden measure other than a basket, of a capacity of 1 qt or more, this reinforcement shall be in the form of a firmly attached metal band.

S.6. Marking Requirements. – A measure shall be conspicuously marked on its side with a statement of its capacity. If the capacity is stated in terms of the pint or quart, the word “Dry” shall be included. The capacity statement shall be in letters of the following dimensions:

- (a) At least $\frac{1}{2}$ in high and $\frac{1}{4}$ in wide on a measure of any capacity between $\frac{1}{2}$ pt and 1 pk.
- (b) At least 1 in high and $\frac{1}{2}$ in wide on a measure of a capacity of $\frac{1}{2}$ bu or more.
- (c) On a measure of a capacity of $\frac{1}{4}$ pt or less, the statement shall be as prominent as practicable, considering the size and design of such measure.

N. Notes

N.1. Testing Medium.

N.1.1. Watertight Dry Measures. – Water shall be used as the testing medium for watertight dry measures.

N.1.2. Non-watertight Dry Measures. – A dry measure shall be tested either volumetrically using rapeseed as a testing medium or geometrically through inside measurement and calculation.

(Amended 1988)

T. Tolerances

T.1. – Maintenance tolerances in excess and in deficiency shall be as shown in Table 2. Maintenance Tolerances, in Excess and in Deficiency, for Dry Measure. Acceptance tolerances shall be one-half the maintenance tolerances.

| Table 2. Maintenance Tolerances, in Excess and in Deficiency, for Dry Measures | | |
|---|-----------------------------------|---------------------------------------|
| Nominal Capacity | Tolerance | |
| | In Excess Cubic Inches | In Deficiency Cubic Inches |
| $\frac{1}{32}$ pint or less | 0.1 | 0.05 |
| $\frac{1}{16}$ pint | 0.15 | 0.1 |
| $\frac{1}{8}$ pint | 0.25 | 0.15 |
| $\frac{1}{4}$ pint | 0.5 | 0.3 |
| $\frac{1}{2}$ pint | 1.0 | 0.5 |
| 1 pint | 2.0 | 1.0 |
| 1 quart | 3.0 | 1.5 |

| Table 2. Maintenance Tolerances, in Excess and in Deficiency, for Dry Measures | | |
|---|-----------------------------------|---------------------------------------|
| Nominal Capacity | Tolerance | |
| | In Excess Cubic Inches | In Deficiency Cubic Inches |
| 2 quarts | 5.0 | 2.5 |
| ½ peck | 10.0 | 5.0 |
| 1 peck | 16.0 | 8.0 |
| ½ bushel | 30.0 | 15.0 |
| 1 bushel | 50.0 | 25.0 |

THIS PAGE INTENTIONALLY LEFT BLANK

MARKUP COPY

Section 4.46. Berry Baskets and Boxes

A. Application

A.1. General. – This code applies to baskets and boxes for berries and small fruits in capacities of 1 dry quart and less.

A.2. Additional Code Requirements. – In addition to the requirements of this code, berry baskets and boxes shall meet the requirements of Section 1.10. General Code.

S. Specifications

S.1. Units. – The capacity of a berry basket or box shall be ½ dry pint, 1 dry pint, or 1 dry quart.

S.2. Materials. – A berry basket or box shall be made of any suitable materials that will retain its shape during normal filling, storage, and handling.

S.3. Capacity Point. – The capacity of a berry basket or box shall be determined by its top edges.

N. Notes

N.1. Method of Test. – A berry basket or box may be tested either volumetrically, using rape seed as the testing medium, or geometrically through accurate inside dimension measurement and calculation.

T. Tolerances

T.1. Tolerances on Individual Measures. – Maintenance and acceptance tolerances in excess and deficiency on an individual measure shall be as shown in Table 1. Maintenance and Acceptance Tolerances in Excess and in Deficiency.

T.2. Tolerances on Average Capacity. – The average capacity on a random sample of 10 measures selected from a lot of 25 or more shall be equal to or greater than the nominal capacity.

(Amended 1979)

| Table 1. Maintenance and Acceptance Tolerances in Excess and in Deficiency | | |
|---|---------------------------|-------------------------------|
| Nominal Capacity | Tolerance | |
| | In Excess Cubic Inches | In Deficiency Cubic Inches |
| ½ pint | 1 | 0.5 |
| 1 pint | 2 | 1.0 |
| 1 quart | 3 | 1.5 |

THIS PAGE INTENTIONALLY LEFT BLANK

MARKUP COPY

Section 5.50. Fabric-Measuring Devices

A. Application

A.1. General. – This code applies only to mechanisms and machines designed to indicate automatically (with or without value-computing capabilities) the length of fabric passed through the measuring elements.

A.2. Devices Used to Measure Other Similar Material in Sheet, Roll, or Bolt Form. – Insofar as they are clearly appropriate, the requirements and provisions of this code apply also to devices designed for the commercial measurement of other material similar to fabrics, in sheet, roll, or bolt form.

A.3. Additional Code Requirements. – In addition to the requirements of this code, Fabric-Measuring Devices shall meet the requirements of Section 1.10. General Code.

S. Specifications

S.1. Units. – A fabric-measuring device shall indicate lengths in terms of 10 cm ($\frac{1}{8}$ yd), 25 cm ($\frac{1}{4}$ yd), 50 cm ($\frac{1}{2}$ yd), and meters (yard). In addition, lengths may be indicated in terms of any or all of the following subdivisions: 30 cm ($\frac{1}{3}$ yd), 6 cm ($\frac{1}{16}$ yd), meters and centimeters (feet and inches). Digital indicators may indicate values in decimal fractions.

(Amended 1977)

S.2. Design of Indicating Elements.

S.2.1. Graduations.

S.2.1.1. Length. – Graduations shall be so varied in length that they may be conveniently read.

S.2.1.2. Width. – In any series of graduations, the width of a graduation shall in no case be greater than the width of the minimum clear interval between graduations, and the width of main graduations shall be not more than 50 % greater than the width of subordinate graduations. Graduations shall in no case be less than 0.2 mm (0.008 in) in width.

S.2.1.3. Clear Interval between Graduations. – The clear interval between graduations shall be at least 6 mm for cm graduations ($\frac{1}{4}$ in for $\frac{1}{8}$ yd graduations), and 3 mm for 20 cm graduations ($\frac{1}{8}$ in for 1 in graduations).

S.2.2. Indicator.

S.2.2.1. Symmetry. – The index of an indicator shall be symmetrical with respect to the graduations, at least throughout that portion of its length associated with the graduations.

S.2.2.2. Length. – The index of an indicator shall reach to the finest graduations with which it is used, unless the indicator and the graduations are in the same plane, in which case the distance between the end of the indicator and the ends of the graduations, measured along the line of the graduations, shall be not more than 1.0 mm (0.04 in).

S.2.2.3. Width. – The index of an indicator shall not be wider than the narrowest graduations with which it is used, and shall in no case exceed 0.4 mm (0.015 in).

S.2.2.4. Clearance. – The clearance between the index of an indicator and the graduations shall in no case be more than 1.5 mm (0.06 in).

S.2.2.5. Parallax. – Parallax effects shall be reduced to the practicable minimum.

S.2.3. Money-Value Computations.

S.2.3.1. Full-Computing Type. – In this type, the money value at each of a series of unit prices shall be computed automatically for every length within the range of measurement of the fabric-measuring device. Value graduations shall be provided and shall be accurately positioned. The value of each graduated interval shall be 1 cent at all prices per yard of 30 cents and less, and shall not exceed 2 cents at higher prices per yard. Five-cent intervals may be represented in the two-cent range by special graduations, but these shall not be positioned in the clear intervals between graduations of the regular series.

S.2.3.2. Limited-Computing Type. – In this type, the money value at each of a series of unit prices shall be computed automatically only for lengths corresponding to a definite series of length graduations. There shall be no value graduations. At no position that the chart can assume shall two value figures at the same price per yard be completely and clearly exposed to view at one time. Money values shown shall be mathematically accurate, except that a fraction of less than ½ cent shall be dropped and the next higher cent shall be shown in the case of a fraction of ½ cent or more. One of the following requirements shall be met:

- (a) There shall be a money-value computation for each length graduation within the range of measurement of the device.
- (b) No money-value computation shall be exposed to view except at such times as the device shows a length indication for which a corresponding series of value indications is computed.
- (c) Each column or row of money-value computations shall be marked to show the length to which the computations correspond, the device shall be marked to show the character and limitations of the computations, and there shall be computations corresponding to at least 10 cm (1/8 yd) throughout the range of measurement of the device.

S.2.4. Return to Zero. – Primary indicating elements shall be readily returnable to a definite zero indication. Means shall be provided to prevent the return of the indicating elements beyond their correct zero positions.

S.3. Marking Requirements. – If a device will not accurately measure all fabrics, it shall be marked to indicate clearly its limitations.

S.4. Design Accuracy. – Indications of length and money value shall be accurate whether the values of the indications are being increased or decreased.

N. Notes

N.1. Testing Medium. – A fabric-measuring device shall be tested with a suitable testing tape approximately 7.62 cm (3 in) wide and with a graduated length of at least 11 m (12 yd), made from such material and having such surface finish as to provide dimensional stability and reduce slippage to the practicable minimum.

T. Tolerances

T.1. Tolerance Values. – Maintenance and acceptance tolerances shall be as shown in Table 1. Maintenance and Acceptance Tolerances for Fabric-Measuring Devices.

| Table 1. Maintenance and Acceptance Tolerances for Fabric-Measuring Devices | | | | |
|--|--|---|--|---|
| Indication of Device (yards) | Maintenance Tolerance | | Acceptance Tolerance | |
| | On Under- registration (inches) | On Over- registration (inches) | On Under- registration (inches) | On Over- registration (inches) |
| 2 or less | $\frac{3}{8}$ | $\frac{1}{4}$ | $\frac{1}{4}$ | $\frac{1}{8}$ |
| 3 | $\frac{3}{8}$ | $\frac{5}{16}$ | $\frac{1}{4}$ | $\frac{5}{32}$ |
| 4 | $\frac{1}{2}$ | $\frac{5}{16}$ | $\frac{1}{4}$ | $\frac{5}{32}$ |
| 5 | $\frac{5}{8}$ | $\frac{3}{8}$ | $\frac{5}{16}$ | $\frac{3}{16}$ |
| 6 | $\frac{3}{4}$ | $\frac{3}{8}$ | $\frac{3}{8}$ | $\frac{3}{16}$ |
| 7 and 8 | 1 | $\frac{1}{2}$ | $\frac{1}{2}$ | $\frac{1}{4}$ |
| 9 | $1\frac{1}{4}$ | $\frac{5}{8}$ | $\frac{5}{8}$ | $\frac{5}{16}$ |
| 10 and 11 | $1\frac{1}{2}$ | $\frac{3}{4}$ | $\frac{3}{4}$ | $\frac{3}{8}$ |
| 12 and 13 | $1\frac{3}{4}$ | $\frac{7}{8}$ | $\frac{7}{8}$ | $\frac{7}{16}$ |
| 14 and 15 | 2 | 1 | 1 | $\frac{1}{2}$ |
| Over 15 | Add $\frac{1}{8}$ inch per indicated yard | Add $\frac{1}{16}$ inch per indicated yard | Add $\frac{1}{16}$ inch per indicated yard | Add $\frac{1}{32}$ inch per indicated yard |

UR. User Requirements

UR.1. Installation Requirements.

UR.1.1. Installation. – A fabric-measuring device shall be securely supported and firmly fixed in position.

UR.2. Use Requirements.

UR.2.1. Limitation of Use. – A fabric-measuring device shall be used to measure only those fabrics that it was designed to measure, and in no case shall it be used to measure a fabric that a marking on the device indicates should not be measured.

UR.2.2. Return of Indicating Elements to Zero. – The primary indicating elements shall be returned to zero before each measurement.

THIS PAGE INTENTIONALLY LEFT BLANK

MARKUP COPY

Section 5.51. Wire- and Cordage-Measuring Devices

A. Application

A.1. General. – This code applies to mechanisms and machines designed to indicate automatically the length of cordage, rope, wire, cable, or similar flexible material passed through the measuring elements.

A.2. Additional Code Requirements. – In addition to the requirements of this code, Wire- and Cordage-Measuring Devices shall meet the requirements of Section 1.10. General Code.

S. Specifications

S.1. Units. – A wire- or cordage-measuring device ~~shall have minimum increments with values that do not exceed the equivalent of 0.1 meter or 0.1 yard~~ shall indicate lengths in terms of feet, yards, or meters, or combinations of units of the same measurement system, and shall have minimum increments with values that do not exceed the equivalent of 0.1 meter or 0.1 yard.

(Amended 1989)

S.2. Design of Indicating Elements.

S.2.1. Graduations.

S.2.1.1. Length. – Graduations shall be so varied in length that they may be conveniently read.

S.2.1.2. Width. – In any series of graduations, the width of a graduation shall in no case be greater than the width of the minimum clear interval between graduations, and the width of main graduations shall be not more than 50 % greater than the width of subordinate graduations. Graduations shall in no case be less than 0.2 mm (0.008 in), nor more than 1.0 mm (0.04 in), in width.

S.2.1.3. Clear Interval between Graduations. – The clear interval between graduations shall be at least as wide as the widest graduation, and in no case less than 0.8 mm (0.03 in).

S.2.2. Indicator.

S.2.2.1. Symmetry. – The index of an indicator shall be symmetrical with respect to the graduations, at least throughout that portion of its length associated with the graduations.

S.2.2.2. Length. – The index of an indicator shall reach to the finest graduations with which it is used, unless the indicator and the graduations are in the same plane, in which case the distance between the end of the indicator and the ends of the graduations, measured along the line of the graduations, shall be not more than 1.0 mm (0.04 in).

S.2.2.3. Width. – The index of an indicator shall not be wider than the narrowest graduations with which it is used, and shall in no case exceed 0.4 mm (0.015 in).

S.2.2.4. Clearance. – The clearance between the index of an indicator and the graduations shall in no case be more than 1.5 mm (0.06 in).

S.2.2.5. Parallax. – Parallax effects shall be reduced to the practicable minimum.

S.2.3. Zero Indication. – Primary indicating elements shall be readily returnable to a definite zero indication.

S.3. Design of Measuring Elements.

S.3.1. Sensitiveness. – If the most sensitive element of the indicating system utilizes an indicator and graduations, the relative movement of these parts corresponding to a measurement of 30 cm (1 ft) shall be not less than 6 mm ($\frac{1}{4}$ in).

S.3.2. Slippage. – The measuring elements of a wire- or cordage-measuring device shall be so designed and constructed as to reduce to the practicable minimum any slippage of material being measured and any lost motion in the measuring mechanism.

S.3.3. Accessibility. – A wire- or cordage-measuring device shall be so constructed that the measuring elements are readily visible and accessible, without disassembly of any supporting frame or section of the main body, for purposes of cleaning or removing any foreign matter carried into the mechanism by the material being measured.

S.4. Marking Requirements.

S.4.1. Limitation of Use. – If a device will measure accurately only certain configurations, diameters, types, or varieties of materials, or with certain accessory equipment, all limitations shall be clearly and permanently stated on the device.

S.4.2. Operating Instructions. – Any necessary operating instructions shall be clearly stated on the device.

S.4.3. Indications. – Indicating elements shall be identified by suitable words or legends so that the values of the indications will be unmistakable.

S.5. Design Accuracy. – Indications of length shall be accurate whether the values of the indications are being increased or decreased.

N. Notes

N.1. Testing Medium. – Wherever feasible, a wire- or cordage-measuring device shall be tested with a steel tape not less than 10 mm ($\frac{3}{8}$ in) in width and at least 15 m (50 ft) in length. When a device cannot be tested in this manner because of the design of the device, it shall be tested with a dimensionally stable material appropriately marked and compared at frequent periodic intervals with a steel tape in order to assure that any marked interval is not in error by more than $\frac{1}{3}$ of the tolerance of the device at that particular interval.

(Amended 1981)

N.2. Minimum Test. – Tests shall be conducted at a minimum initial increment of 5 m (20 ft) and appropriate increments up to at least 15 m (50 ft).

T. Tolerances

T.1. Tolerance Values. – Maintenance and acceptance tolerances shall be as shown in Table 1. Maintenance and Acceptance Tolerances for Wire- and Cordage-Measuring Devices.

| Table 1. Maintenance and Acceptance Tolerances for Wire- and Cordage-Measuring Devices | | |
|---|--|---|
| Indication of Device (feet) | Acceptance and Maintenance Tolerances | |
| | On Underregistrati (inches) | On Overregistration (inches) |
| 20 | 6 | 3 |
| Over 20 to 30 | 8 | 4 |
| Over 30 to 40 | 10 | 5 |
| Over 40 to 50 | 12 | 6 |
| Over 50 | Add 2 inches per indicated 10 feet | Add 1 inch per indicated 10 feet |

UR. User Requirements

UR.1. Installation Requirements.

UR.1.1. Installation. – A wire- or cordage-measuring device shall be securely supported and firmly fixed in position.

UR.2. Use Requirements.

UR.2.1. Limitation of Use. – A wire- or cordage-measuring device shall be used to measure only those materials that it was designed to measure, and in no case shall it be used to measure a material that a marking on the device indicates should not be measured.

UR.2.2. Return to Zero. – The primary indicating elements of a wire- or cordage-measuring device shall be returned to zero before each measurement.

UR.2.3. Operation of Device. – A wire- or cordage-measuring device shall not be operated in such a manner as to cause slippage or inaccurate measurement.

UR.2.4. Cleanliness. – The measuring elements of a wire- or cordage-measuring device shall be kept clean to prevent buildup of dirt and foreign material that would adversely affect the measuring capability of the device.

THIS PAGE INTENTIONALLY LEFT BLANK

MARKUP COPY

Section 5.52. Linear Measures

A. Application

A.1. General. – This code applies to any linear measure or measure of length, whether flexible or inflexible, permanently installed or portable.

A.2. Additional Code Requirements. – In addition to the requirements of this code, Linear Measures shall meet the requirements of Section 1.10. General Code.

S. Specifications

S.1.M. Units. – A linear measure may be in total length, and the total length may be subdivided in any or all of the following:

- (a) centimeters and tenths of the centimeter;
- (b) meters; and
- (c) multiples of meters.

A 1-meter measure may be graduated, in addition, to show 0.1 m and multiples of 0.1 m subdivisions.

S.1. Units. – A linear measure may be in total length, and the total length may be subdivided in any or all of the following:

- (a) inches and binary submultiples of the inch;
- (b) feet;
- (c) yards and multiples of yards.

A 1-yard measure may be graduated, in addition, to show $\frac{1}{3}$ yd and $\frac{2}{3}$ yd subdivisions. A flexible tape may be graduated in tenths or hundredths of a foot, or both tenths and hundredths of a foot. (Any other subdivisions are allowable only on measures of special purposes and when required for such purposes.)

S.2. Material.

S.2.1. Flexible Tape. – A flexible tape shall be made of metal.

S.2.2. End Measure. – If an end measure is made of material softer than brass, the ends of the measure shall be protected by brass (or other metal at least equally hard) securely attached.

S.3. Finish. – Measures shall be smoothly finished.

S.4. Design.

S.4.1. Rigid Measure. – A rigid measure shall be straight.

S.4.2. Folding Measure. – A folding measure shall open to a definite stop, and when so opened shall be straight.

S.5. Graduations.

S.5.1. General. – Graduations shall be perpendicular to the edge of the measure.

S.5.2. Width. – The width of the graduations on any measure shall not exceed one-half the width of the smallest graduated interval on the measure, and in no case shall be wider than 0.75 mm (0.03 in).

(Amended 1982)

T. Tolerances

T.1. For Measures Except Metal Tapes. – Maintenance tolerances in excess and in deficiency for measures except metal tapes shall be as shown in Table 1. Maintenance Tolerances, in Excess and in Deficiency, for Linear Measures Except Metal Tapes. Acceptance tolerances shall be one-half the maintenance tolerances.

| Table 1. | |
|--|------------------|
| Maintenance Tolerances, in Excess and in Deficiency, for Linear Measures Except Metal Tapes | |
| Nominal Interval from Zero | Tolerance |
| Feet | Inch |
| ½ or less | 1/64 |
| 1 | 1/32 |
| 2 | 1/16 |
| 3 | 3/32 |
| 4 | 1/8 |
| 5 | 5/32 |
| 6 | 3/16 |

T.2. For Metal Tapes. – Maintenance and acceptance tolerances in excess and in deficiency for metal tapes shall be as shown in Table 2. Maintenance and Acceptance Tolerances, in Excess and in Deficiency, for Metal Tapes. Tapes of 10 m (25 ft) or over shall be tested at a tension resulting from a load of 5 kg (10 lb). Tapes less than 10 m (25 ft) shall be tested at a tension resulting from a load of 2.5 kg (5 lb). However, flexible metal tapes of 10 m (25 ft) or less that are not normally used under tension shall be tested with no tension applied. All tapes shall be supported throughout on a horizontal flat surface whenever tested.

(Amended 1972)

| Table 2. | |
|--|------------------|
| Maintenance and Acceptance Tolerances, in Excess and in Deficiency, for Metal Tapes | |
| Nominal Interval from Zero | Tolerance |
| Feet | Inch |
| 6 or less | 1/32 |
| 7 to 30, inclusive | 1/16 |
| 31 to 55, inclusive | 1/8 |
| 56 to 80, inclusive | 3/16 |
| 81 to 100, inclusive | 1/4 |

Section 5.53. Odometers

A. Application

A.1. General. – This code applies to odometers that are used or are to be used to determine the charges for rent or hire of passenger vehicles and trucks and buses. (When official examinations are undertaken on odometers that form the basis for the payment of fees or taxes to, or the preparation of reports for, governmental agencies, and in similar cases, the requirements of this code shall be applied insofar as they are applicable and appropriate to the conditions of such special uses.)

(Amended 1977)

A.2. Exceptions. – This code does not apply to taximeters (for which see Section 5.54. Code for Taximeters).

(Amended 1977)

A.3. Additional Code Requirements. – In addition to the requirements of this code, Odometers shall meet the requirements of Section 1.10. General Code.

S. Specifications

S.1. Design of Indicating Elements.

S.1.1. General. – The primary indicating element of an odometer may be:

- (a) the distance-traveled portion of the “speedometer” assembly of a motor vehicle;
- (b) a special cable-driven distance-indicating device; or
- (c) a hub odometer attached to the hub of a wheel on a motor vehicle.

(Amended 1977)

S.1.2. Units. – An odometer shall indicate in terms of miles or kilometers.

(Amended 1977)

S.1.3. Minimum Indicated Value. – The value of the interval of indicated distance shall be:

- (a) for odometers indicating in kilometers, 0.1 kilometer; or
- (b) for odometers indicating in miles, 0.1 mile.

(Amended 1977)

S.1.4. Advancement of Indicating Elements. – The most sensitive indicating elements of an odometer may advance continuously or intermittently; all other elements shall advance intermittently. Except when the indications are being returned to zero, the indications of an installed odometer shall be susceptible to advancement only by the rotation of the vehicle wheel or wheels.

(Amended 1977)

S.1.5. Readability. – Distance figures and their background shall be of sharply contrasting colors. Figures indicating tenth units shall be differentiated from other figures with different colors, or with a decimal point, or by other equally effective means. Except during the period of advance of any decade to the next higher indication, only one figure in each decade shall be exposed to view. Any protective covering intended to be transparent shall be in such condition that it can be made transparent by ordinary cleaning of its exposed surface.

(Amended 1977)

S.1.6. Digital Indications and Representation. – Digital indicating odometers (discontinuous registration) shall “round off” indications to the nearest minimum division or truncate indications to the lower minimum division.

(Added 1990)

N. Notes

N.1. Testing Procedures.

N.1.1. Test Methods. – To determine compliance with distance tolerances, a distance test of an odometer shall be conducted using one or more of the following test methods:

- (a) Road Test. – A road test consists of driving the vehicle over a precisely measured road course.
- (b) Fifth-Wheel Test. – A fifth-wheel test consists of driving the vehicle over any reasonable road course and determining the distance actually traveled through the use of a mechanism known as a “fifth wheel” that is attached to the vehicle and that independently measures and indicates the distance.
- (c) Simulated-Road Test. – A simulated-road test consists of determining the distance traveled by use of a roller device, or by computation from rolling circumference and wheel-turn data.

(Amended 1977)

N.1.2. Test Runs. – Not less than two test runs shall be conducted. Acceleration and deceleration shall be carefully controlled to avoid spinning or skidding the wheels.

(Amended 1977)

N.1.2.1. For Devices Indicating in Miles. – The test runs shall be 2 mi in length, shall start from, and finish at, a dead stop with a minimum of 80 % of the run between 30 mi/h and 45 mi/h.

(Added 1977)

N.1.2.2. For Devices Indicating in Kilometers. – The test runs shall be 3 km in length, shall start from, and finish at, a dead stop with a minimum of 80 % of the run between 50 km/h and 75 km/h.

(Added 1977)

N.1.3. Test Conditions.

N.1.3.1. Tire Stabilization. – Road tests or fifth-wheel tests shall be preceded by a run of at least 8 km or 5 mi, for the purpose of stabilizing tire pressures. Simulated road tests on a roller device shall be made at stable tire pressures.

(Amended 1977)

N.1.3.2. Tire Pressure. – At the completion of the test run or runs, the tires of the vehicle under test shall be checked to determine that the tire pressure is that operating tire pressure posted in the vehicle. If not, the tire pressure should be adjusted to the posted tire pressure and further tests may be conducted to determine the operating characteristics of the odometer.

(Amended 1977)

N.1.3.3. Vehicle Loading.

- (a) **Passenger Load.** – During the distance test of an odometer, the vehicle may carry two persons.
 - (b) **Truck Cargo Load.** – Truck odometers shall be tested by one of the following methods:
 - (1) the truck is loaded with one-half of the maximum cargo load; or
 - (2) unloaded if unloaded test tolerances are applied.
- (Amended 1977 and 1987)

T. Tolerances

T.1. To Underregistration and to Overregistration. – The tolerances hereinafter prescribed shall be applied to errors of underregistration and errors of overregistration.

T.2. Tolerance Values. – Except for unloaded trucks, maintenance and acceptance tolerances on odometers shall be 4 % of the interval under test.

(Amended 1977 and 1987)

T.2.1. Tolerances for Unloaded Trucks. – Maintenance and acceptance tolerances on truck odometers shall be 5 % for underregistration and 3 % for overregistration of the interval under test.

(Added 1987)

UR. User Requirements

UR.1. Inflation of Vehicle Tires. – The operational tire pressure of passenger vehicle and truck tires shall be posted in the vehicle and tires shall be maintained at the posted pressure.

(Amended 1977)

THIS PAGE INTENTIONALLY LEFT BLANK

MARKUP COPY

Section 5.54. Taximeters

A. Application

A.1. General. – This code applies to taximeters; that is, to devices that automatically calculates at a predetermined rate or rates and indicate the charge for hire of a vehicle.

A.2. Exceptions. – This code does not apply to odometers on vehicles that are rented on a distance basis (for which see Section 5.53. Code for Odometers).

(Amended 1977)

A.3. Additional Code Requirements. – In addition to the requirements of this code, Taximeters shall meet the requirements of Section 1.10. General Code.

S. Specifications

S.1. Design of Indicating and Recording Elements.

S.1.1. General. – A taximeter shall be equipped with a primary indicating element and may be equipped with a recording element.

(Amended 1988)

S.1.2. Advancement of Indicating Elements. – Except when a taximeter is being cleared, the primary indicating and recording elements shall be susceptible of advancement only by the movement of the vehicle or by the time mechanism.

(Amended 1988)

S.1.3. Visibility of Indications. – The indications of fare, including extras, and the mode of operation, such as “time” or “hired,” shall be constantly displayed whenever the meter is in operation. All indications of passenger interest shall be easily read from a distance of 1.2 m (4 ft) under any condition of normal operation.

(Amended 1977, 1986, and 1988)

S.1.3.1. Minimum Height of Figures, Words, and Symbols. – The minimum height of the figures used to indicate the fare shall be 10 mm and for extras, 8 mm. The minimum height of the figures, words, or symbols used for other indications, including those used to identify or define, shall be 3.5 mm.

(Added 1986)

S.1.3.2. Lighting of Indications. – *Integral lighting shall be provided to illuminate the fare, extras, the rate or rate code, and the taximeter status (i.e., vacant, hired, and time off).*

[Nonretroactive as of January 1, 1989]

(Added 1988) (Amended 1990)

S.1.4. Actuation of Fare-Indicating Mechanism. – When a taximeter designed to calculate fares upon the basis of a combination of distance traveled and time elapsed is operative with respect to fare indication, the fare-indicating mechanism shall be actuated by the distance mechanism whenever the vehicle is in motion at such a speed that the rate of distance revenue equals or exceeds the time rate, and may be actuated by the time mechanism whenever the vehicle speed is less than this and when the vehicle is not in motion. Means shall be provided for the vehicle operator to render the time mechanism either operative or inoperative with respect to the fare-indicating mechanism.

(Amended 1977)

S.1.5. Operating Condition.

S.1.5.1. General. – When a taximeter is cleared, the indication “Not Registering,” “Vacant,” or an equivalent expression shall be shown. Whenever a taximeter is set to register charges, it shall indicate “Registering,” “Hired,” or an equivalent expression and the rate at which it is set shall be automatically indicated (Rate 1 or Rate A, for example).

(Amended 1988)

S.1.5.2. Time not Recording. – When a taximeter is set for fare registration with the time mechanism inoperative, it shall indicate “Time Not Recording” or an equivalent expression.

(Amended 1988)

S.1.6. Fare Identification. – Fare indications shall be identified by the word “Fare” or by an equivalent expression. Values shall be defined by suitable words or monetary signs.

S.1.7. Extras. – Extras shall be indicated as a separate item and shall not be included in the fare indication. They shall be identified by the word “Extras” or by an equivalent expression. Values shall be defined by suitable words or monetary signs. Means may be provided to totalize the fare and extras if the totalized amount returns to separate indications of fare and extras within 5 seconds or less.

(Amended 1988)

S.1.7.1. Nonuse of Extras. – If and when taximeter extras are prohibited by legal authority or are discontinued by a vehicle operator, the extras mechanisms shall be rendered inoperative or the extras indications shall be effectively obscured by permanent means.

S.1.8. Protection of Indications. – Indications of fare and extras shall be displayed through and entirely protected by glass or other suitable transparent material securely attached to the housing of the taximeter.

S.1.9. Recorded Representation. – *A printed receipt issued from a taximeter, whether through an integral or separate recording element, shall include the following:*

(a) *date;*

(b) *unique vehicle identification number, such as the medallion number, taxi number, vehicle identification number (VIN) or permit number;**

(c) *start and end time of trip;**

(d) *distance traveled, maximum increment of 0.1 kilometer (0.1 mile);**

(e) *fare in \$;*

(f) *for multi-rate taximeters, each rate at which fare was computed and the associated fare at that rate;**

(g) *additional charges where permitted such as extras, surcharge, telephone use, tip and tax shall be identified and itemized;** and

(h) *total fare in \$ (total charge).**

*[Nonretroactive as of January 1, 1989] *[Nonretroactive as of January 1, 2000]*

(Added 1988) (Amended 1999)

S.1.9.1. Multiple Recorded Representations.

S.1.9.1.1. Duplicate Receipts. – A recording element may produce a duplicate receipt for the previous transaction provided the information printed is identical to the original with the exception of time issued. The duplicate receipt shall include the words “duplicate” or “copy.” The feature to print a duplicate receipt shall be deactivated at the time the meter is hired for the next fare.
[Nonretroactive as of January 1, 2000]

(Added 1999)

S.1.10. Non-fare Information. – The fare and extras displays may be used to display auxiliary information provided the meter is in the vacant condition and such information is only displayed for 10 seconds, or less. If the information consists of a list of information, the list may be displayed one item after another, provided that each item is displayed for 10 seconds, or less.
[Nonretroactive as of January 1, 2002]

(Added 2000)

S.2. Basis of Fare Calculations. – A taximeter shall calculate fares only upon the basis of:

- (a) distance traveled;
- (b) time elapsed; or
- (c) a combination of distance traveled and time elapsed.

(Amended 1977)

S.2.1. Initial Time and Distance Intervals. – The time and distance intervals of a taximeter shall be directly proportional as expressed in the following formula:

$$\frac{\text{Seconds of Initial Time Interval}}{\text{Seconds per Non – Initial Time Interval}} = \frac{\text{Distance of Initial Mileage Interval}}{\text{Distance per Non – Initial Mileage Interval}}$$

$$\frac{\text{Seconds of Initial Time Interval}}{\text{Seconds per Non – Initial Time Interval}} = \frac{\text{Distance of Initial Mileage Interval}}{\text{Distance per Non – Initial Mileage Interval}}$$

(Added 1990)

S.3. Design of Operating Control.

S.3.1. Positions of Control. – The several positions of the operating controls shall be clearly defined and shall be so constructed that accidental or inadvertent changing of the operating condition of the taximeter is improbable. Movement of the operating controls to an operating position immediately following movement to the cleared position shall be delayed enough to permit the taximeter to come to a complete rest in the cleared position.

(Amended 1988)

S.3.2. Flag. – If the control for the operating condition is a lever-arm and flag, the flag shall be at its highest position when the taximeter is cleared, and in this position the whole of the flag shall be above the level of the taximeter housing.

S.3.3. Control for Extras Mechanism. – The knob, handle, or other means provided to actuate the extras mechanism shall be inoperable whenever the taximeter is cleared.

S.4. Interference. – The design of a taximeter shall be such that there will be no interference between the time and the distance portions of the mechanism device at any speed of operation.

(Amended 1977 and 1988)

S.5. Provision for Security Seals. – Adequate provision shall be made to provide security for a taximeter. Security may be provided either by:

- (a) Affixing security seals to the taximeter and to all other components required for service operation of a complete installation on a vehicle, so that no adjustments, alterations, or replacements affecting accuracy or indications of the device or the assembly can be made without mutilating the seal or seals; or
- (b) Using a combination of security seals described in paragraph (a) and, in the case of a component that may be removed from a vehicle (e.g., slide mounting the taximeter), providing a physical or electronic link between components affecting accuracy or indications of the device to ensure that its performance is not affected and operation is permitted only with those components having the same unique properties.

The sealing means shall be such that it is not necessary to disassemble or remove any part of the device or of the vehicle to apply or inspect the seals.

(Amended 1988 and 2000)

S.6. Power Interruption, Electronic Taximeters.

- (a) After a power interruption of 3 seconds or less, the fare and extras indications shall return to the previously displayed indications and may be susceptible to advancement without the taximeter being cleared.
- (b) After a power interruption exceeding 3 seconds, the fare and extras indications shall return to the previously displayed indications and shall not be susceptible to advancement until the taximeter is cleared.

*After restoration of power following an interruption exceeding 3 seconds, the previously displayed fare shall be displayed for a maximum of 1 minute at which time the fare shall automatically clear and the taximeter shall return to the vacant condition.**

*[*Nonretroactive as of January 1, 2002]*

(Added 1988) (Amended 1989, 1990, and 2000)

S.7. Anti-Fraud Provisions, Electronic Taximeters. – An electronic taximeter may have provisions to detect and eliminate distance input that is inconsistent with output of the vehicle's distance sensor. When a taximeter equipped with this feature detects input inconsistent with the distance sensor:

- (a) The meter shall either filter out the inconsistent distance input signals or cease to increment fare based on distance until the distance input signal returns to normal. If the meter ceases to increment fare based on distance, the taximeter may continue to increment fare based on elapsed time;
- (b) The taximeter shall provide a visible or audible signal that inconsistent input signals are being detected; and
- (c) The taximeter shall record the occurrence in an event logger. The event logger shall include an event counter (000 to 999), the date, and the time of at least the last 1000 occurrences.

(Added 2001)

N. Notes

N.1. Distance Tests.

N.1.1. Test Methods. – To determine compliance with distance tolerances, a distance test of a taximeter shall be conducted utilizing one or more of the following test methods:

- (a) **Road Test.** – A road test consists of driving the vehicle over a precisely measured road course.
- (b) **Fifth-Wheel Test.** – A fifth-wheel test consists of driving the vehicle over any reasonable road course and determining the distance actually traveled through the use of a mechanism known as a “fifth wheel” that is attached to the vehicle and that independently measures and indicates the distance.
- (c) **Simulated-Road Test.** – A simulated road test consists of determining the distance traveled by use of a roller device, or by computation from rolling circumference and wheel-turn data.

(Amended 1977)

N.1.2. Test Procedures. – The distance test of a taximeter, whether a road test, a simulated-road test, or a fifth-wheel test, shall include at least duplicate runs of sufficient length to cover at least the third money drop or 1 mi, whichever is greater, and shall be at a speed approximating the average speed traveled by the vehicle in normal service. In the case of metric-calibrated taximeters, the test should cover at least the third money drop or 2 km, whichever is greater.

(Amended 1977)

N.1.3. Test Conditions.

N.1.3.1. Vehicle Lading. – During the distance test of a taximeter, the vehicle shall carry two persons, or in the case of a simulated-road test, 70 kg or 150 lb of test weights may be substituted in lieu of the second person.

N.1.3.2. Tire Pressure. – At the completion of test run or runs, the tires of the vehicle under test shall be checked to determine that the tire pressure is that operating tire pressure posted in the vehicle. If not, the tire pressure should be adjusted to the posted tire pressure and further tests may be conducted to determine the operating characteristics of the odometer.

(Amended 1977)

N.2. Time Test. – If a taximeter is equipped with a timing device through which charges are made for time intervals, the timer shall be tested at the initial interval, four separate subsequent intervals, and an average time test of at least four consecutive subsequent time intervals.

(Amended 1988)

N.3. Interference Test. – If a taximeter is equipped with a timing device through which charges are made for time intervals, a test shall be conducted to determine whether there is interference between the time and distance elements. During the interference test, the vehicle’s operating speed shall be 3 km/h or 4 km/h, or 2 mi/h or 3 mi/h faster than the speed at which the basic distance rate equals the basic time rate. The basic rate per hour divided by the basic rate per mile is the speed (km/h or mi/h) at which the basic time rate and basic distance rate are equal.

(Amended 1988)

T. Tolerances

T.1. Tolerance Values.

T.1.1. On Distance Tests. – Maintenance and acceptance tolerances for taximeters shall be as follows:

- (a) On Overregistration: 1 % of the interval under test.
- (b) On Underregistration: 4 % of the interval under test, with an added tolerance of 30 m or 100 ft whenever the initial interval is included in the interval under test.

T.1.2. On Time Tests.

T.1.2.1. On Individual Time Intervals. – Maintenance and acceptance tolerances on individual time intervals shall be as follows:

- (a) On Overregistration: 3 seconds per minute (5 %).
- (b) On Underregistration: 9 seconds per minute (15 %) on the initial interval, and 6 seconds per minute (10 %) on subsequent intervals.

T.1.2.2. On Average Time Interval Computed After the Initial Interval. – Except for the initial interval, maintenance and acceptance tolerances on the average time interval shall be as follows:

- (a) On Overregistration: 0.2 second per minute (0.33 %).
 - (b) On Underregistration: 3 seconds per minute (5 %).
- (Amended 1991)

T.1.3. On Interference Tests.

T.1.3.1. The registration of a taximeter in the “time on” position shall agree within 1 % of its performance in the “time off” position.

(Added 1988)

UR. User Requirements

UR.1. Inflation of Vehicle Tires. – The operational tire pressure of passenger vehicles and truck tires shall be posted in the vehicle and shall be maintained at the posted pressure.

(Amended 1977)

UR.2. Position and Illumination of Taximeter. – A taximeter shall be so positioned and illuminated that its indications, operational markings, and controls of passenger interest can be conveniently read by a passenger seated in the back seat of the vehicle.

(Amended 1985 and 1986)

UR.3. Statement of Rates. – The distance and time rates for which a taximeter is set, including the initial distance interval and the initial time interval, the local tax rate, and the schedule of extras when an extras indication is provided shall be conspicuously displayed inside the front and rear passenger compartments. The words “Rate,” “Rates,” or “Rates of Fare” shall precede the rate statement. The rate statement shall be fully informative, self-explanatory, and readily understandable by the ordinary passenger, and shall either be of a permanent character or be protected by glass or other suitable transparent material.

(Amended 1977, 1988, 1990, and 1999)

Section 5.55. Timing Devices

A. Application

A.1. General. – This code applies to devices used to measure time during which services are being dispensed (such as vehicle parking, laundry drying, and car washing).

A.2. Additional Code Requirements. – In addition to the requirements of this code, Timing Devices shall meet the requirements of Section 1.10. General Code.

S. Specifications

S.1. Design of Indicating and Recording Elements and of Recorded Representations.

S.1.1. Primary Elements.

S.1.1.1. General. – A timing device shall be equipped with a primary indicating element, and may also be equipped with a primary recording element. A readily observable in-service light or other equally effective means that automatically indicates when laundry driers, vacuum cleaners, and car washes are in operation shall be deemed an appropriate primary indicating element.

(Amended 1979)

S.1.1.2. Units. – A timing device shall indicate and record, if the device is equipped to record, the time in terms of minutes for time intervals of 60 minutes or less and in hours and minutes for time intervals greater than 60 minutes.

S.1.1.3. Value of Smallest Unit. – The value of the smallest unit of indicated time and recorded time, if the device is equipped to record, shall not exceed the equivalent of:

- (a) one-half hour on parking meters indicating time in excess of two hours;
- (b) six minutes on parking meters indicating time in excess of one but not greater than two hours; or
- (c) five minutes on all other devices, except those equipped with an in-service light.

(Amended 1975)

S.1.1.4. Advancement of Indicating and Recording Elements. – Primary indicating and recording elements shall be susceptible to advancement only during the mechanical operation of the device, except that clocks may be equipped to manually reset the time.

S.1.1.5. Operation of In-Service Indicator Light. – The in-service light indicator shall be operative only during the time the device is in operation.

S.1.1.6. Discontinuous Indicating Parking Meters. – An indication of the time purchased shall be provided at the time the meter is activated in units of no more than one minute for times less than one hour and not more than two minutes for times of one hour or more. Convenient means shall be provided to indicate to the purchaser the unexpired time.

(Added 1975) (Amended 1976)

S.1.2. Graduations.

S.1.2.1. Length. – Graduations shall be so varied in length that they may be conveniently read.

S.1.2.2. Width. – In any series of graduations, the width of a graduation shall in no case be greater than the width of the minimum clear interval between graduations and the width of main graduations shall be not more than 50 % greater than the width of subordinate graduations. Graduations shall in no case be less than 0.2 mm (0.008 in) in width.

S.1.2.3. Clear Interval Between Graduations. – The clear interval shall be not less than 0.75 mm (0.03 in). If the graduations are not parallel, the measurement shall be made:

- (a) along the line of relative movement between the graduations at the end of the indicator; or
- (b) if the indicator is continuous, at the point of widest separation of the graduations.

S.1.3. Indicators.

S.1.3.1. Symmetry. – The index of an indicator shall be symmetrical with respect to the graduations, at least throughout that portion of its length associated with the graduations.

S.1.3.2. Length. – The index of an indicator shall reach to the finest graduations with which it is used, unless the indicator and the graduations are in the same plane, in which case the distance between the end of the indicator and the ends of the graduations, measured along the line of the graduations, shall be not more than 1.0 mm (0.04 in).

S.1.3.3. Width. – The width of the index of an indicator in relation to the series of graduations with which it is used shall be not greater than:

- (a) the width of the widest graduation; and
- (b) the width of the minimum clear interval between the graduations.

S.1.3.4. Parallax. – Parallax effect shall be reduced to a practicable minimum.

S.1.4. Printed Tickets. – A printed ticket issued or stamped by a timing device shall have printed clearly thereon:

- (a) the time and day when the service ends and the time and day when the service begins, except that a self-service money-operated device that clearly displays the time of day need not record the time and day when the service begins; or
- (b) the time interval purchased, and the time and day that the service either begins or ends.

(Amended 1983)

S.2. Marking Requirements, Operating Instructions. – Operating instructions shall be clearly stated on the device.

N. Notes

N.1. Test Method. – A timing device shall be tested with a timepiece with an error of not greater than plus or minus 15 seconds per 24-hour period. In the test of timing devices with a nominal capacity of 1 hour or less, stopwatches with a minimum division of not greater than one-fifth second shall be used. In the test of timing devices with a nominal capacity of more than one hour, the value of the minimum division on the timepiece shall be not greater than one second. Time pieces and stopwatches shall be calibrated with standard time signals as

described in National Institute of Standards and Technology Special Publication 432, NIST Time and Frequency Dissemination Services, or any superseding publication.

(Amended 1978)

N.2. Broadcast Times and Frequencies. – Time and frequency standards are broadcast by the stations listed in Table N.2. Broadcast Times and Frequencies.

| Table N.2.* | | | |
|--|---|------------------------------------|--|
| Broadcast Times and Frequencies | | | |
| Station | Location, Latitude, Longitude | Frequency (MHz) | Times of Transmission (UTC) |
| WWV | Fort Collins, Colorado 40°41' N 105°02' W | 2.5 5.0 10.0 15.0 20.0 | Continuous |
| WWVH | Kauai, Hawaii 21°59' N 159°46' W | 2.5 5.0 10.0 15.0 | Continuous |
| CHU | Ottawa, Canada 45°18' N 75°45' W | 3.330 7.335 14.670 14.670 | Continuous |

*From NIST Special Publication 559, "Time and Frequency Users' Manual," 1990.

(Added 1988)

T. Tolerances

T.1. Tolerance Values. – Maintenance and acceptance tolerances for timing devices shall be as follows:

T.1.1. For Timing Devices Other Than Those Specified in T.1.2. For Time Clocks and Time Recorders and T.1.3. On Parking Meters. – The maintenance and acceptance tolerances shall be:

- (a) On Overregistration: 5 seconds for any time interval of 1 minute or more; and

(Amended 1986)

- (b) On Underregistration: 6 seconds per indicated minute.

(Amended 1975)

T.1.2. For Time Clocks and Time Recorders. – The maintenance and acceptance tolerances on over-registration and underregistration shall be three seconds per hour, but not to exceed one minute per day.

(Amended 1975)

T.1.3. On Parking Meters. – The maintenance and acceptance tolerances are shown in Table T.1.3. Maintenance and Acceptance Tolerances for Parking Meters.

| Table T.1.3. Maintenance and Acceptance Tolerances for Parking Meters | | |
|--|----------------------------|--|
| Maintenance and Acceptance Tolerances | | |
| Nominal Time Capacity | On Overregistration | On Underregistration |
| 30 minutes or less | No tolerance | 10 seconds per minute, but not less than 2 minutes |
| Over 30 minutes to and including 1 hour | No tolerance | 5 minutes plus 4 seconds per minute over 30 minutes |
| Over 1 hour | No tolerance | 7 minutes plus 2 minutes per hour over 1 hour |

T.2. Tests Involving Digital Indications or Representations. – To the tolerances that would otherwise be applied, there shall be added an amount equal to one-half the minimum value that can be indicated or recorded.

UR. User Requirements

UR.1. Statement of Rates. – The price in terms of money per unit or units of time for the service dispensed and the number of coins the device will accept and be activated by at one time, shall be clearly, prominently, and conspicuously displayed.

(Amended 1976)

UR.2. Time Representations. – Any time representation shall be within plus or minus 2 minutes of the correct time in effect in the area, except on an individual clock used only for “time out”; in addition, the time indication of the “time-out” clock shall be the same as or less than that of the “time-in” clock.

(Amended 1975)

Section 5.56.(a) Grain Moisture Meters

Section 5.56. was reorganized into two sections beginning with the 1997 Edition of NIST Handbook 44. This Section, 5.56.(a), applies to all NTEP grain moisture meters. It also applies to any grain moisture meter manufactured or placed into service after January 1, 1998.

(Code reorganized and renumbered 1996)

A. Application

A.1. General Code. – This code applies to grain moisture meters, that is, devices used to indicate directly the moisture content of cereal grain and oil seeds. The code consists of general requirements applicable to all moisture meters and specific requirements applicable only to certain types of moisture meters. Requirements cited for “test weight per bushel” indications or recorded representations are applicable only to devices incorporating an automatic test weight per bushel measuring feature.

(Amended 2003)

A.2. Exceptions. – This code does not apply to devices used for in-motion measurement of grain moisture content or seed moisture content.

A.3. Type Evaluation. – The National Type Evaluation Program (NTEP) will accept for type evaluation only those devices that comply with this code. State enforcement will be based upon the effective dates identified with each requirement when specific dates are shown.

(Added 1993)

A.4. Additional Code Requirements. – In addition to the requirements of this code, 5.56.(a) Grain Moisture Meters shall meet the requirements of Section 1.10. General Code.

S. Specifications

S.1. Design of Indicating, Recording, and Measuring Elements.

S.1.1. Digital Indications and Recording Elements.

- (a) Meters shall be equipped with a digital indicating element.
- (b) The minimum height for the digits used to display moisture content shall be 10 mm.
- (c) Meters shall be equipped with a communication interface that permits interfacing with a recording element and transmitting the date, grain type, grain moisture results, test weight per volume results, and calibration version identification.
- (d) A digital indicating element shall not display, and a recording element shall not record, any moisture content values or test weight per volume values before the end of the measurement cycle.
- (e) Moisture content results shall be displayed and recorded as percent moisture content, wet basis. Test weight per bushel results shall be displayed and recorded as pounds per bushel. Subdivisions of these units shall be in terms of decimal subdivisions (not fractions).
- (f) A meter shall not display or record any moisture content or test weight per volume values when the moisture content of the grain sample is beyond the operating range of the device, unless the moisture and test weight representations include a clear error indication (and recorded error message with the recorded representation).

- (g) On multi-constituent meters (e.g., meters which also measure grain protein), provision shall be made for displaying and recording the constituent label (such as moisture, protein, etc.) to make it clear which constituent is associated with each of the displayed and recorded values.

(Added 1995)

(Amended 1993, 1994, 1995, 1996, and 2003)

S.1.2. Selecting or Recording Grain or Seed Type and Class. – Provision shall be made for selecting and recording the type and class or multi-class group (as appropriate) of grain or seed to be measured. The means to select the type and class or multi-class group of grain or seed shall be readily visible and the type and class or multi-class group of grain or seed selected shall be clearly and definitely identified. Abbreviations for grain types and multi-class groups indicated on the meter must meet the minimum acceptable abbreviations listed in Table S.1.2. Grain Types and Multi-Class Groups Considered for Type Evaluation and Calibration and Their Minimum Acceptable Abbreviations.

(Amended 1993, 1995, and 2007)

| <i>Grain Type</i> | <i>Grain Class</i> | <i>Minimum Acceptable Abbreviation</i> |
|--|--------------------------------|--|
| <i>Barley</i> | <i>All-Class Barley*</i> | <i>BARLEY</i> |
| | <i>Six-Rowed Barley</i> | <i>SRB</i> |
| | <i>Two-Rowed Barley</i> | <i>TRB</i> |
| <i>Corn</i> | --- | <i>CORN</i> |
| <i>Grain Sorghum</i> | --- | <i>SORG or MILO</i> |
| <i>Oats</i> | --- | <i>OATS</i> |
| <i>Rice</i> | <i>All-Class Rough Rice*</i> | <i>RGHRICE</i> |
| | <i>Long Grain Rough Rice</i> | <i>LGRR</i> |
| | <i>Medium Grain Rough Rice</i> | <i>MGRR</i> |
| <i>Small Oil Seeds (under consideration)</i> | --- | --- |
| <i>Soybeans</i> | --- | <i>SOYB</i> |
| <i>Sunflower seed (Oil)</i> | --- | <i>SUNF</i> |
| <i>Wheat</i> | <i>All-Class Wheat*</i> | <i>WHEAT</i> |
| | <i>Durum Wheat</i> | <i>DURW</i> |
| | <i>Hard Red Spring Wheat</i> | <i>HRSW</i> |
| | <i>Hard Red Winter Wheat</i> | <i>HRWW</i> |
| | <i>Hard White Wheat</i> | <i>HDWW</i> |
| | <i>Soft Red Winter Wheat</i> | <i>SRWW</i> |
| | <i>Soft White Wheat</i> | <i>SWW</i> |
| | <i>Wheat Excluding Durum*</i> | <i>WHTEXDUR</i> |

Note: Grain Types marked with an asterisk (*) are “Multi-Class Calibrations.”

[Nonretroactive as of January 1, 1998]

(Table Added 1993) (Amended 1995, 1998, and 2007)

S.1.3. Operating Range. – A meter shall automatically and clearly indicate when the operating range of the meter has been exceeded. The operating range shall specify the following:

- (a) **Temperature Range of the Meter.** – The temperature range over which the meter may be used and still comply with the applicable requirements shall be specified. The minimum temperature range shall be 10 °C to 30 °C. No moisture value may be displayed when the temperature range is exceeded. An appropriate message shall be displayed when the temperature of the meter is outside its specified operating range.
- (b) **Temperature Range of each Grain or Seed.** – The temperature range for each grain or seed for which the meter is to be used shall be specified. The minimum temperature range for each grain shall be 0 °C to 40 °C. No moisture value may be displayed when the temperature range is exceeded. An appropriate error message shall be displayed when the temperature of the grain sample exceeds the specified temperature range for the grain.
- (c) **Moisture Range of the Grain or Seed.** – The moisture range for each grain or seed for which the meter is to be used shall be specified. Moisture and test weight per bushel values may be displayed when the moisture range is exceeded if accompanied by a clear indication that the moisture range has been exceeded.
(Amended 2003)
- (d) **Maximum Allowable Meter/Grain Temperature Difference.** – The maximum allowable difference in temperature between the meter and the sample for which an accurate moisture determination can be made shall be specified. The minimum temperature difference shall be 10 °C. No moisture value may be displayed when the maximum allowable temperature difference is exceeded. An appropriate error message shall be displayed when the difference in temperature between the meter and the sample exceeds the specified difference.

(Added 1993) (Amended 1995)

S.1.4. Value of Smallest Unit. – The display shall permit moisture value determination to both 0.01 % and 0.1 % resolution. The 0.1 % resolution is for commercial transactions; the 0.01 % resolution is for type evaluation and calibration purposes only, not for commercial purposes. Test weight per bushel values shall be determined to the nearest 0.1 pound per bushel.

(Amended 2003)

S.1.5. Operating Temperature.

- (a) Warm-up period: When a meter is turned on it shall not display or record any usable values until the operating temperature necessary for accurate determination has been attained, or the meter shall bear a conspicuous statement adjacent to the indication stating that the meter shall be turned on for a time period specified by the manufacturer prior to use.
- (b) A meter shall meet the requirements of T.2. Tolerances when operated in the temperature range of 10 °C to 30 °C (50 °F to 86 °F) or within the range specified by the meter manufacturer.
- (c) If the manufacturer specifies a temperature range, the range shall be at least 20 °C (36 °F).

(Added 1993) (Amended 1995 and 1996)

S.2. Design of Grain Moisture Meters.

S.2.1. Minimum Sample Size. – Meters shall be designed to measure the moisture content of representative-size grain samples. The minimum allowable sample size used in analysis shall be 100 g or 400 kernels or seeds, whichever is smaller.

(Added 1993) (Amended 1995)

S.2.2. Electric Power Supply.**S.2.2.1. Power Supply, Voltage and Frequency.**

- (a) A meter that operates using alternating current must perform within the tolerances defined in Section T.2. Tolerances over the line voltage range 100 V to 130 V, or 200 V to 250 V rms as designed, and over the frequency range of 59.5 Hz to 60.5 Hz.
- (b) Battery-operated instruments shall not indicate or record values outside the applicable tolerance limits when battery power output is excessive or deficient.

S.2.2.2. Power Interruption. – A power interruption shall not cause an indicating or recording element to display or record any values outside the applicable tolerance limits.

(Added 1988)

S.2.3. Level Indicating Means. – A meter shall be equipped with a level indicator and leveling adjustments if its performance is changed by an amount greater than the applicable tolerance when the meter is moved from a level position to a position that is out of level in any upright direction by up to 5 % (approximately three degrees). The level-indicating means shall be readable without removing any meter parts requiring a tool.

(Added 1988) (Amended 1994)

S.2.4. Calibration Integrity.

S.2.4.1. Calibration Version. – A meter must be capable of displaying either calibration constants, a unique calibration name, or a unique calibration version number for use in verifying that the latest version of the calibration is being used to make moisture content and test weight per bushel determinations.

(Added 1993) (Amended 1995 and 2003)

S.2.4.2. Calibration Corruption. – If calibration constants are digitally stored in an electronically alterable form, the meter shall be designed to make automatic checks to detect corruption of calibration constants. An error message must be displayed if calibration constants have been electronically altered.

(Added 1993) (Amended 1995)

S.2.4.3. Calibration Transfer. – *The instrument hardware/software design and calibration procedures shall permit calibration development and the transfer of calibrations between instruments of like models without requiring user slope or bias adjustments.*

[Note: Only the manufacturer or the manufacturer's designated service agency may make standardization adjustments on moisture meters. This does not preclude the possibility of the operator installing manufacturer-specified calibration constants under the instructions of the manufacturer or its designated service agency.] Standardization adjustments (not to be confused with grain calibrations) are those physical adjustments or software parameters which make meters of like type respond identically to the grain(s) being measured.

[Nonretroactive as of January 1, 1999]

(Added 1994) (Amended 1998)

S.2.5. Provision for Sealing. – Provision shall be made for applying a security seal in a manner that requires the security seal to be broken, or for using other approved means of providing security (e.g., audit trail available at the time of inspection as defined in Table S.2.5. Categories of Device and Methods of Sealing) before any change that affects the metrological integrity of the device can be made to any mechanism.

| Table S.2.5. Categories of Device and Methods of Sealing | |
|---|--|
| Categories of Device | Methods of Sealing |
| <p>Category 1: No remote configuration capability.</p> | <p>Seal by physical seal or two event counters: one for calibration parameters (000 to 999) and one for configuration parameters (000 to 999). If equipped with event counters, the device must be capable of displaying, or printing through the device or through another on-site device, the contents of the counters.</p> |
| <p>Category 2: Remote configuration capability, but access is controlled by physical hardware.</p> <p>A device shall clearly indicate that it is in the remote configuration mode and shall not be capable of operating in the measure mode while enabled for remote configuration.</p> | <p>The hardware enabling access for remote communication must be at the device and sealed using a physical seal or two event counters: one for calibration parameters (000 to 999) and one for configuration parameters (000 to 999). If equipped with event counters, the device must be capable of displaying, or printing through the device or through another on-site device, the contents of the counters.</p> |
| <p>Category 3: Remote configuration capability access may be unlimited or controlled through a software switch (e.g., password).</p> <p>When accessed remotely for the purpose of modifying sealable parameters, the device shall clearly indicate that it is in the configuration mode and shall not be capable of operating in the measuring mode.</p> | <p>An event logger is required in the device; it must include an event counter (000 to 999), the parameter ID, the date and time of the change, and the new value of the parameter (for calibration changes consisting of multiple constants, the calibration version number may be used rather than the calibration constants). A printed copy of the information must be available through the device or through another on-site device. The event logger shall have a capacity to retain records equal to 25 times the number of sealable parameters in the device, but not more than 1000 records are required. (Note: Does not require 1000 changes to be stored for each parameter.)</p> |
| <p>Category 3a: No remote capability, but operator is able to make changes that affect the metrological integrity of the device (e.g., slope, bias, etc.) in normal operation.</p> <p>*When accessed for the purpose of modifying sealable parameters, the device shall clearly indicate that it is in the configuration mode and shall not be capable of operating in the measuring mode.</p> | <p>Same as Category 3</p> |
| <p>Category 3b: No remote capability, but access to metrological parameters is controlled through a software switch (e.g., password).</p> <p>*When accessed for the purpose of modifying sealable parameters, the device shall clearly indicate that it is in the configuration mode and shall not be capable of operating in the measuring mode.</p> | <p>Same as Category 3</p> |

[Nonretroactive as of January 1, 1999]

[*Nonretroactive as of January 1, 2014]

(Amended 1998 and 2013)

Note: Zero-setting and test point adjustments are considered to affect metrological characteristics and must be sealed.

(Added 1993) (Amended 1995 and 1997)

S.2.6. Determination of Quantity and Temperature. – The moisture meter system shall not require the operator to judge the precise volume or weight and temperature needed to make an accurate moisture determination. External grinding, weighing, and temperature measurement operations are not permitted. In addition, if the meter is capable of measuring test weight per bushel, determination of sample volume and weight for this measurement shall be fully automatic *and means shall be provided to ensure that measurements of test weight per volume are not allowed to be displayed or printed when an insufficient sample volume is available to provide an accurate measurement.* [Nonretroactive as of January 1, 2004]

(Added 1994) (Amended 1995 and 2003)

S.3. Accessory Equipment. – When the operating instructions for a moisture meter require accessory equipment separate from and external to the moisture meter, such equipment shall be appropriate and complete for the measurement.

S.4. Operating Instructions and Use Limitations. – The manufacturer shall furnish operating instructions for the device and accessories that include complete information concerning the accuracy, sensitivity, and use of accessory equipment necessary in obtaining a moisture content. Operating instructions shall include the following information:

- (a) name and address or trademark of the manufacturer;
- (b) the type or design of the device with which it is intended to be used;
- (c) date of issue;
- (d) the kinds or classes of grain or seed for which the device is designed to measure moisture content and test weight per bushel; and

(Amended 2003)

- (e) the limitations of use, including but not confined to the moisture measurement range, grain or seed temperature, maximum allowable temperature difference between grain sample and meter, kind or class of grain or seed, moisture meter temperature, voltage and frequency ranges, electromagnetic interferences, and necessary accessory equipment.

(Added 1984)

N. Notes

N.1. Testing Procedures. – Field evaluation of grain moisture meters shall be performed by one of the following methods:

N.1.1. Air Oven Reference Method Transfer Standards. – Official grain samples shall be used as the official transfer standards with moisture content and test weight per bushel values assigned by the reference methods. The reference methods for moisture shall be the oven drying methods as specified by the USDA GIPSA. The test weight per bushel value assigned to a test weight transfer standard shall be the average of 10 test weight per bushel determinations using the quart kettle test weight per bushel apparatus as specified by the USDA GIPSA. Tolerances shall be applied to the average of at least three measurements on each official grain sample. Official grain samples shall be clean and naturally moist, but not tempered (i.e., water not added).

(Amended 1992, 2001, and 2003)

N.1.2. Minimum Test. – A minimum test of a grain moisture meter shall consist of tests using samples (need not exceed three) of each grain or seed type for which the device is used, and for each grain or seed type shall include the following:

- (a) tests of moisture indications, using samples having at least two different moisture content values within the operating range of the device; and
- (b) if applicable, tests of test weight per volume indications, with at least the lowest moisture samples used in (a) above.

(Added 2003)

(Amended 1986, 1989, and 2003)

N.1.3. Meter to Like-Type Meter Method Transfer Standards. – Properly standardized reference meters using National Type Evaluation Program approved calibrations shall be used as transfer standards. A reference meter shall be of the same type as the meter under test. Tests shall be conducted side-by-side using, as a comparison medium, grain samples that are clean and naturally moist, but not tempered (i.e., water not added).

(Added 2001)

T. Tolerances

T.1. To Underregistration and to Overregistration. – The tolerances hereinafter prescribed shall be applied to errors of underregistration and errors of overregistration.

T.2. Tolerances.

T.2.1. Air Oven Reference Method. – Maintenance and acceptance tolerances shall be as shown in Table T.2.1. Acceptance and Maintenance Tolerances Air Oven Reference Method. Tolerances are expressed as a fraction of the percent moisture content of the official grain sample, together with a minimum tolerance.

(Amended 2001)

| Table T.2.1. Acceptance and Maintenance Tolerances Air Oven Reference Method | | |
|---|---|------------------------------|
| Type of Grain, Class, or Seed | Tolerance | Minimum Tolerance |
| Corn, oats, rice, sorghum, sunflower | 0.05 of the percent moisture content | 0.8 % in moisture content |
| All other cereal grains and oil seeds | 0.04 of the percent moisture content | 0.7 % in moisture content |

(Amended 2001)

T.2.2. Meter to Like-Type Meter Method. – Maintenance and acceptance tolerances shall be as shown in Table T.2.2. Acceptance and Maintenance Tolerances Meter to Like-Type Meter Method. The tolerances shall apply to all types of grain and seed.

(Added 2001)

| Table T.2.2. Acceptance and Maintenance Tolerances Meter to Like-Type Meter Method | |
|---|------------------------------|
| Sample Reference Moisture | Tolerance |
| Up to 22 % | 0.5 % in moisture content |

(Added 2001)

T.3. For Test Weight Per Bushel Indications or Recorded Representations. – The maintenance and acceptance tolerances on test weight per bushel indications or recorded representations shall be as shown in Table T.3. Acceptance and Maintenance Tolerances Test Weight per Bushel. Tolerances are (+) positive or (–) negative with respect to the value assigned to the official grain sample.

(Amended 1992 and 2003)

| Table T.3. Acceptance and Maintenance Tolerances Test Weight per Bushel | |
|--|--------------------------------------|
| Type of Grain or Seed | Tolerance (Pounds Per Bushel) |
| Corn, oats | 0.8 |
| All wheat classes | 0.5 |
| Soybeans, all barley classes, all rice classes, sunflower, sorghum | 0.7 |

(Added 2003)

UR. User Requirements

UR.1. Selection Requirements.

UR.1.1. Value of the Smallest Unit on Primary Indicating and Recording Elements. – The resolution of the moisture meter display shall be 0.1 % moisture and 0.1 pounds per bushel test weight during commercial use.

(Amended 2003)

UR.1.2. See G-UR.1.2. Environment.

UR.2. Installation Requirements. – The grain moisture meter shall be installed in an environment within the range of temperature and/or other environmental factors specified in the operating instructions.

UR.3. Use Requirements.

UR.3.1. Operating Instructions. – The operating instructions for the use of the grain moisture meter shall be readily available to the user, service technician, and weights and measures official at the place of installation. It shall include a list of accessory equipment and the kinds of grain or seed to be measured with the moisture meter.

(Amended 1988)

UR.3.2. Other Devices Not Used for Commercial Measurement. – If there are other moisture meters on the premises not used for trade or determining other charges for services, these devices shall be clearly and conspicuously marked “Not for Use in Trade or Commerce.”

UR.3.3. Maintaining Integrity of Grain Samples. – Whenever there is a time lapse (temperature change) between taking the sample and testing the sample, means to prevent condensation of moisture or loss of moisture from grain samples shall be used. For example, a cold grain sample may be kept in a closed container in order to permit the cold grain to come to the operating temperature range of the meter before the grain moisture measurements are made.

UR.3.4. Printed Tickets.

- (a) Printed tickets shall be free from any previous indication of moisture content or type of grain or seed selected.
- (b) The customer shall be given a printed ticket showing at the time of the transaction or as otherwise specified by the customer. The printed ticket shall include the date, grain type, grain moisture results, test weight per bushel, and calibration version identification. The ticket information shall be generated by the grain moisture meter system.

(Amended 1993, 1995, **2003**, and ~~2003~~**2013**)

UR.3.5. Accessory Devices. – Accessory devices, if necessary in the determination of a moisture content value, shall be in close proximity to the moisture meter and allow immediate use.

UR.3.6. Sampling. – A grain sample shall be obtained by following appropriate sampling methods and equipment. These include, but are not limited to grain probes of appropriate length used at random locations in the bulk, the use of a pelican sampler, or other techniques and equipment giving equivalent results. The grain sample shall be taken such that it is representative of the lot.

UR.3.7. Location. – ~~See~~**Also see** G-UR.3.3. Position of Equipment.

UR.3.8. Level Condition. – If equipped with a level indicator, a meter shall be maintained in a level condition.

(Added 1988)

UR.3.9. Current Calibration Data. – Grain moisture determinations shall be made using only the most recently published calibration data.

(Added 1988)

UR.3.10. Posting of Meter Operating Range. – The operating range of the grain moisture meter shall be clearly and conspicuously posted in the place of business such that the information is readily visible from a reasonable customer position. The posted information shall include the following:

- (a) The temperature range over which the meter may be used and still comply with the applicable requirements. If the temperature range varies for different grains or seed, the range shall be specified for each.
- (b) The moisture range for each grain or seed for which the meter is to be used.
- (c) The temperature range for each grain or seed for which the meter is to be used.
- (d) The maximum allowable difference in temperature that may exist between the meter and the sample for which an accurate moisture determination can be made.

(Added 1988)

THIS PAGE INTENTIONALLY LEFT BLANK

MARKUP COPY

Section 5.56.(b) Grain Moisture Meters

Section 5.56. was reorganized into two sections beginning with the 1997 Edition of NIST Handbook 44. This Section, 5.56.(b), applies to all non-NTEP grain moisture meters manufactured or placed into service before January 1, 1998.

(Code reorganized and renumbered 1996)

A. Application

A.1. General. – This code applies to grain moisture meters; that is, devices used to indicate directly or through conversion and/or correction tables the moisture content of cereal grain and oil seeds. The code consists of general requirements applicable to all moisture meters and specific requirements applicable only to certain types of moisture meters.

A.2. Exceptions. – This code does not apply to devices used for in-motion measurement of grain moisture content or seed moisture content.

A.3. Additional Code Requirements. – In addition to the requirements of this code, 5.56.(b) Grain Moisture Meters shall meet the requirements of Section 1.10. General Code.

S. Specifications

S.1. Design of Indicating and Recording Elements and of Recorded Representations.

S.1.1. Primary Elements, General. – A meter shall be equipped with a primary indicating element and may also be equipped with a primary recording element. If the meter indicates directly and/or is equipped to record, the meter shall indicate and/or record its measurements in terms of percent moisture content, wet basis. Subdivisions of this unit shall be in terms of decimal subdivisions (not fractions). If the meter indicates in the conventional scale and requires conversion or correction tables, the resulting values after use of such tables shall be in terms of percent moisture content, wet basis. Subdivisions of this unit shall be in terms of decimal subdivisions (not fractions).

S.1.2. Digital Indications.

S.1.2.1. Measurement Completion. – A digital indicating element shall not display any values (either moisture content or conventional scale) before the end of the measurement cycle.

S.1.3. Graduations.

S.1.3.1. Length. – Graduations shall be so varied in length that they may be conveniently read.

S.1.3.2. Width. – In any series of graduations, the width of a graduation shall in no case be greater than the width of the minimum clear interval between graduations, and the width of the main graduations shall be not more than 50 % greater than the width of subordinate graduations. Graduations shall in no case be less than 0.2 mm (0.008 in) in width.

S.1.3.3. Clear Interval between Graduations. – The clear interval shall be not less than 0.75 mm (0.03 in) between graduations. If the graduations are not parallel, the measurement shall be made:

- (a) along the line of relative movement between the graduations at the end of the indicator; or
- (b) if the indicator is continuous, at the point of widest separation of the graduations.

S.1.4. Indicators.

S.1.4.1. Symmetry. – The index of an indicator shall be symmetrical with respect to the graduations, at least throughout that portion of its length associated with the graduations.

S.1.4.2. Length. – The index of an indicator shall reach to the finest graduations with which it is used, unless the indicator and the graduations are in the same plane, in which case the distance between the end of the indicator and the ends of the graduations, measured along the line of the graduations, shall be not more than 1.0 mm (0.04 in).

S.1.4.3. Width. – The width of the index of an indicator in relation to the series of graduations with which it is used shall be not greater than:

- (a) the width of the widest graduation; nor
- (b) the width of the minimum clear interval between graduations.

When the index of an indicator extends along the entire length of a graduation, that portion of the index of the indicator that may be brought into coincidence with the graduation shall be of the same width as the graduation throughout the length of the index that coincides with the graduation.

S.1.4.4. Clearance. – The clearance between the index of an indicator and the graduations shall in no case be more than 1.5 mm (0.06 in).

S.1.4.5. Parallax. – Parallax effects shall be reduced to the practicable minimum.

S.1.5. Recording Elements.

S.1.5.1. General. – If a meter is equipped with a recording element, it shall record in terms of percent moisture content, wet basis only, and not in terms of conventional scale.

S.1.5.2. Measurement Completion. – A recording element shall not record any values before the end of the measurement cycle.

S.1.5.3. Range of Moisture Content. – A recording element shall not record any values when the moisture content of the grain sample is beyond the operating range of the device.

S.1.6. Design of Direct Reading Grain Moisture Meters.

S.1.6.1. Grain or Seed Kind and Class Selection and Recording. – Provision shall be made for selecting and recording, if equipped to record, the kind and class (as appropriate) of grain or seed to be measured. The means to select the kind and class of grain or seed shall be readily visible and the kind and class of grain or seed selected shall be clearly and definitely identified in letters (such as Wheat or WHT, HRWW, etc.).

S.1.6.2. Operating Range. – A meter shall automatically and clearly indicate when the operating range of the meter has been exceeded or the manufacturer shall:

- (a) clearly and conspicuously mark the operating ranges on the meter; or
- (b) furnish the operating ranges of the meter and the means to clearly and conspicuously display this information on or immediately adjacent to the device.

The operating range shall specify the following:

- (a) *the temperature range over which the meter may be used and still comply with the applicable requirements;*
- (b) *the moisture range for each grain or seed for which the meter is to be used;*
- (c) *the temperature range for each grain or seed for which the meter is to be used; and*
- (d) *the maximum allowable difference in temperature between the meter and the sample for which an accurate moisture determination can be made.*

Examples of clearly indicating these conditions include an error indication, flashing the displayed moisture value, or blanking the display.

[Nonretroactive as of January 1, 1989]

(Amended 1986 and 1988)

S.1.6.3. Value of Smallest Unit. – The value of the minimum indicated or recorded moisture indication shall not be greater than 0.1 %.

S.1.7. Electric Power Supply.

S.1.7.1. Power Supply, Voltage and Frequency.

- (a) *A meter that operates using alternating current must perform within the tolerances defined in Section T.2. Tolerance Values over the line voltage range 100 V to 130 V, or 200 V to 250 V rms as designed, and over the frequency range of 59.5 Hz to 60.5 Hz.*
- (b) *Battery-operated instruments shall not indicate or record values outside the applicable tolerance limits when battery power output is excessive or deficient.*

[Nonretroactive as of January 1, 1989]

S.1.7.2. Power Interruption. – A power interruption shall not cause an indicating or recording element to display or record any values outside the applicable tolerance limits.

[Nonretroactive as of January 1, 1989]

(Added 1988)

S.1.8. Level Indicating Means. – A meter shall be equipped with a level indicator and leveling adjustments if its performance is changed by an amount greater than the applicable tolerance when the meter is moved from a level position to a position that is out of level in any upright direction by up to 5 % (approximately 3 degrees).

The level-indicating means shall be readable without removing any meter parts requiring a tool.

[Nonretroactive as of January 1, 1989]

(Added 1988) (Amended 1994)

S.1.9. Operating Temperature.

- (a) *A meter shall not display or record any usable values until the operating temperature necessary for accurate determination has been attained, or the meter shall bear a conspicuous statement adjacent to the indication stating that the meter shall be turned on for a time period specified by the manufacturer prior to use.*
- (b) *A meter shall meet the requirements of T.2. Tolerance Values when operated in the temperature range of 2 °C to 40 °C (35 °F to 104 °F) or within the range specified by the meter manufacturer.*

(c) *If the manufacturer specifies a temperature range, the range shall be at least 10 °C (20 °F) and shall be marked on the device.*
[Nonretroactive as of January 1, 1989]
(Added 1988)

S.2. Design of Measuring Elements.

S.2.1. Design of Zero-Setting and Test Point Mechanisms. – If a grain moisture meter is equipped with a zero setting and/or test point mechanism(s), this (these) mechanism(s) shall be adjustable only with a tool outside and entirely separate from this mechanism or enclosed in a cabinet. This requirement shall not apply to manual operations that the operator must make (following operating instructions) in order to obtain a meter reading on a grain sample.

S.2.2. Provision for Sealing. – Provision shall be made for applying a security seal in a manner that requires the security seal to be broken before an adjustment can be made to any component of the grain moisture meter that is set by the manufacturer or authorized service representative and not intended to be adjusted by the user.

S.3. Accessory Equipment. – When the operating instructions for a moisture meter require accessory equipment separate from and external to the moisture meter, such equipment shall be appropriate and complete for the measurement.

S.3.1. Grain-Test Scale. – If the moisture meter requires the weighing of the grain sample, the weighing device shall meet the requirements of the General Code and those applicable portions of the Scales Code.

S.3.2. Thermometers or Other Temperature Sensing Equipment.

- (a) The temperature sensing equipment or thermometer shall be designed to be in direct contact with a grain sample in a closed container. It is acceptable to insert thermometer through a small hole in the lid of the container used to hold the grain sample.
- (b) A separate thermometer or other temperature sensing equipment shall have temperature divisions not greater than the temperature increments used by the manufacturer in the correction table.

(Amended 1988)

S.3.3. Conversion and Correction Tables. – Conversion and correction tables, charts, graphs, slide rules, or other apparatus to convert the conventional scale values read from a moisture meter to moisture content values, if such apparatus is required, shall be appropriate and correct for the moisture meter being used and shall be marked with the following information:

- (a) name and address or trademark of the manufacturer;
- (b) the type or design of the device with which it is intended to be used;
- (c) date of issue;
- (d) the kinds or classes of grain or seed for which the device is designed to measure moisture content;

(e) the limitations of use, including but not confined to the moisture measurement range, grain or seed temperature, kind or class of grain or seed, moisture meter temperature, voltage and frequency ranges, electromagnetic interferences, and necessary accessory equipment; but

(f) values exceeding any measurement range shall not be included.

(Added 1984)

S.3.4. Operating Instructions and Use Limitations. – Operating instructions shall be furnished by the manufacturer with each device with all of the information required by paragraph S.3.3. Conversion and Correction Tables. Complete information concerning the accuracy, sensitivity, and use of accessory equipment (e.g., test weight per bushel equipment, thermometer, etc.) necessary in obtaining moisture content shall be included.

N. Notes

N.1. Testing Procedures.

N.1.1. Transfer Standards. – Official grain samples shall be used as the official transfer standards with moisture content values assigned by the reference methods. The reference methods shall be the oven drying methods as specified by the USDA GIPSA. Tolerances shall be applied to the average of at least three measurements on each official grain sample. Official grain samples shall be clean and naturally moist, but not tempered (i.e., water not added).

(Amended 1992)

N.1.2. Minimum Test. – A minimum test of a grain moisture meter shall consist of tests with:

(a) samples (need not exceed three) of each grain or seed for which the device is used; and

(b) samples having at least two different moisture content values within the operating range of the device.

(Amended 1986 and 1989)

N.1.3. Temperature Measuring Equipment. – The accuracy of accessory temperature measuring equipment shall be determined by comparison with a calibrated temperature sensor, such as a total immersion thermometer with 0.1 °C (0.2 °F) subdivisions, indicating over a range of from 0 °C to 40 °C (32 °F to 104 °F) with a maximum error of ± 0.1 °C (0.2 °F). Tests shall be conducted at two temperatures using liquid baths (e.g., ice water and room temperature water). The two temperatures selected shall not exceed the range of temperatures identified in the moisture meter operating instructions.

(Amended 1988)

T. Tolerances⁴²

T.1. To Underregistration and to Overregistration. – The tolerances hereinafter prescribed shall be applied to errors of underregistration and errors of overregistration.

T.2. Tolerance Values. – Maintenance and acceptance tolerances shall be as shown in Table T.2. Acceptance and Maintenance Tolerances for Grain Moisture Meters. Tolerances are expressed as a fraction of the percent moisture content of the official grain sample, together with a minimum tolerance.

⁴² These tolerances do not apply to tests in which grain moisture meters are the transfer standards.

| Table T.2. Acceptance and Maintenance Tolerances for Grain Moisture Meters | | |
|---|---|------------------------------|
| Type of Grain or Seed | Tolerance | Minimum Tolerance |
| Corn, oats, rice, sorghum, sunflower | 0.05 of the percent moisture content | 0.8 % in moisture content |
| All other cereal grains and oil seeds | 0.04 of the percent moisture content | 0.7 % in moisture content |

T.3. For Test Weight Per Bushel Devices. – The maintenance and acceptance tolerances on separate test weight per bushel devices used to determine the test weight per bushel of grain samples for the purposes of making density corrections in moisture determination shall be 0.193 kg/hL or 0.15 lb/bu. The test methods used shall be those specified by the USDA GIPSA using a dockage-free sample of dry hard red winter wheat.
(Amended 1992 and 2003)

T.4. Thermometers or Other Temperature Sensing Equipment. – The tolerance for a separate thermometer or temperature sensing equipment used to determine the temperature of grain samples for the purpose of making temperature corrections in moisture determinations shall be ± 0.5 °C (1 °F).
(Added 1988)

UR. User Requirements

UR.1. Selection Requirements.

UR.1.1. Value of the Smallest Unit on Primary Indicating and Recording Elements. – The value of the smallest unit on a moisture meter, whether the moisture meter reads directly in terms of moisture content, or when the conventional scale unit is converted or corrected to moisture content, shall be equal to or less than 0.1 %.

UR.1.2. Environment. – Equipment shall be suitable for the environment in which it is used including, but not limited to, the effects of wind, weather, and RFI.

UR.2. Installation Requirements. – The grain moisture meter shall be installed in an environment within the range of temperature and/or other environmental factors specified:

- (a) in the operating manual; and
- (b) on the conversion or correction tables if such tables are necessary for the operation of the device.

UR.3. Use Requirements.

UR.3.1. Operating Instructions. – The operating instructions for the use of the grain moisture meter shall be readily available to the user, service technician, and weights and measures official at the place of installation. It shall include a list of accessory equipment, conversion and correction charts if any are required to obtain moisture content values, and the kinds of grain or seed to be measured with the moisture meter.
(Amended 1988)

UR.3.2. Other Devices not used for Commercial Measurement. – If there are other moisture meters on the premises not used for trade or determining other charges for services, these devices shall be clearly and conspicuously marked “Not for Use in Trade or Commerce.”

UR.3.3. Maintaining Integrity of Grain Samples. – Whenever there is a time lapse (temperature change) between taking the sample and testing the sample, means to prevent condensation of moisture or loss of

moisture from grain samples shall be used. For example, a cold grain sample may be kept in a closed container in order to permit the cold grain to come to the operating temperature range of the meter before the grain moisture measurements are made.

UR.3.4. Printed Tickets. – Printed tickets shall be free from any previous indication of moisture content or type of grain or seed selected.

UR.3.5. Accessory Devices. – Accessory devices, if necessary in the determination of a moisture content value, shall be in close proximity to the moisture meter and allow immediate use.

UR.3.6. Sampling. – A grain sample shall be obtained by following appropriate sampling methods and equipment. These include, but are not limited to, grain probes of appropriate length used at random locations in the bulk, the use of a pelican sampler, or other techniques and equipment giving equivalent results. The grain sample shall be taken such that it is representative of the lot.

UR.3.7. Location. – See G-UR.3.3. Position of Equipment.

UR.3.8. Level Condition. – If equipped with a level indicator, a meter shall be maintained in a level condition.

(Added 1988)

UR.3.9. Operating Limitation. – Unless otherwise specified by the meter manufacturer, moisture determinations shall not be made when the difference in temperatures between the grain sample and the meter exceeds 10 °C (20 °F).

(Added 1988)

UR.3.10. Current Calibration Chart or Data. – Grain moisture determinations shall be made using only the most recently published calibration charts or calibration data.

(Added 1988)

UR.3.11. Posting of Meter Operating Range. – The operating range of the grain moisture meter shall be clearly and conspicuously posted in the place of business such that the information is readily visible from a reasonable customer position. The posted information shall include the following:

- (a) The temperature range over which the meter may be used and still comply with the applicable requirements. If the temperature range varies for different grains or seed, the range shall be specified for each.
- (b) The moisture range for each grain or seed for which the meter is to be used.
- (c) The temperature range for each grain or seed for which the meter is to be used.
- (d) The maximum allowable difference in temperature that may exist between the meter and the sample for which an accurate moisture determination can be made.

(Added 1988)

THIS PAGE INTENTIONALLY LEFT BLANK

MARKUP COPY

Section 5.57. Near-Infrared Grain Analyzers

A. Application

A.1. General. – This code applies to near-infrared (NIR) grain analyzers; that is, devices used to indicate the constituent values (other than moisture content) of grain using near-infrared reflectance or transmittance technology. These instruments may analyze either whole grain or ground grain samples. The code consists of general requirements applicable to all NIR analyzers and specific requirements applicable only to certain types of NIR analyzers, grain types, or grain constituents. In addition to meeting the requirements of this code, a whole grain NIR analyzer that displays a measured moisture value must also comply with the requirements of the Grain Moisture Meters Code.

(Added 2001)

A.2. Exceptions. – This code does not apply to devices used for in-motion measurement of grain constituent values.

A.3. Calibrations. – The National Type Evaluation Program (NTEP) Certificate of Conformance (CC) shall indicate the native moisture basis of each calibration. The “native” moisture basis is the default moisture basis of the sealable constituent calibration (or constituent calibration pair when a non-displayed moisture calibration is also involved). If an NIR analyzer uses a self-generated moisture measurement internally but does NOT display or record a moisture value, the moisture calibration shall be considered to be a part of the constituent calibration. For such calibrations, the CC shall state: “Includes non-displayed moisture calibration.” Changes to any part of such calibrations shall require changes to the CC.

(Added 2001)

A.4. Additional Code Requirements. – In addition to the requirements of this code, Near-Infrared Grain Analyzers shall meet the requirements of Section 1.10. General Code.

S. Specifications

S.1. Design of Indicating, Recording, and Measuring Elements.

S.1.1. Digital Indications and Recording Elements.

- (a) *Analyzers shall be equipped with a digital indicating element.*
- (b) *The minimum height for the digits used to display constituent values shall be 10 mm.*
- (c) *Analyzers shall be equipped with a communication interface that permits interfacing with a recording element and transmitting the date, grain type or class, constituent values, the moisture basis for each constituent value (except moisture), and calibration version identification. If the analyzer converts constituent results to a manually entered moisture basis, the “native” concentration and the “native” moisture basis must appear on the printed ticket in addition to the converted results and the manually entered moisture basis.*
(Amended 2001 and 2003)
- (d) *A digital indicating element shall not display, and a recording element shall not record, any constituent value before the end of the measurement cycle.*
- (e) *Constituent content shall be recorded and displayed as percent of total mass at the specified moisture basis. The moisture basis shall also be recorded and displayed for each constituent content result (except moisture). If a whole grain analyzer that is calibrated to display results on an “as is” moisture basis does NOT display or record a moisture value, it must clearly indicate that results are*

expressed on an “as is” moisture basis. Ground grain analyzers must ALWAYS display and record a moisture measurement for “as is” content results (except moisture).

(Amended 2001 and 2003)

- (f) *An analyzer shall not display or record any constituent value that is beyond the operating range of the device unless the constituent value representation includes a clear error indication (and recorded error message with the recorded representation).*
- (g) *If an NIR analyzer is used to determine a moisture value, either to determine the moisture of an “as is” constituent content measurement or to convert from one moisture basis to another, the moisture measurement must be concurrent with the measurement of other constituents.*
- (h) *If the analyzer incorporates a built-in printer, or if a printer is available as an accessory to the analyzer, the information appearing on the printout shall be arranged in a consistent and unambiguous manner.*

(Added 2003)

[Nonretroactive as of January 1, 2003]

(Added 2001)

S.1.2. Selecting and Recording Grain Class and Constituent. – *Provision shall be made for selecting and recording the type or class or multi-class group of grain and the constituent(s) to be measured. The means to select the grain type or class or multi-class group and the constituent(s) shall be readily visible and the type or class or multi-class group of grain and the constituent(s) selected shall be clearly and definitely identified in letters (such as HRWW, HRSW, WHEAT, etc., or PROT, etc.). A symbol to identify the display of the type or class or multi-class group of grain and constituent(s) selected is permitted provided that it is clearly defined adjacent to the display. Minimum acceptable abbreviations are listed in Table S.1.2. Grain Types and Multi-Class Groups Considered for Type Evaluation and Calibration and Their Minimum Acceptable Abbreviations.*

[Nonretroactive as of January 1, 2003]

If more than one calibration is included for a given grain type, the calibrations must be clearly distinguished from one another.

[Nonretroactive as of January 1, 2004]

(Amended 2003 and 2007)

| Table S.1.2. Grain Types and Multi-Class Groups Considered for Type Evaluation and Calibration and Their Minimum Acceptable Abbreviations | | |
|--|-----------------------|--|
| Grain Type | Grain Class | Minimum Acceptable Abbreviation |
| Barley | Two-Rowed Barley | TRB |
| | Six-Rowed Barley | SRB |
| | All-Class Barley* | BARLEY |
| Corn | --- | CORN |
| Soybeans | --- | SOYB |
| Wheat | All-Class Wheat* | WHEAT |
| | Durum Wheat | DURW |
| | Hard Red Spring Wheat | HRSW |
| | Hard Red Winter Wheat | HRWW |
| | Hard White Wheat | HDWW |
| | Soft Red Winter Wheat | SRWW |
| | Soft White Wheat | SWW |
| Wheat Excluding Durum* | WHTXDUR | |

[Note: Grain Types marked with an asterisk (*) are “Multi-Class Calibrations”]
[Nonretroactive as of January 1, 2003]

(Table Amended 2001 and 2007)

S.1.3. Operating Range. – An analyzer shall automatically and clearly indicate when the operating range of the device has been exceeded. The statement of the operating range shall be specified in the operator’s manual and shall operate as follows:

- (a) The ambient temperature range over which the analyzer may be used and still comply with the applicable requirements shall be specified. The minimum temperature range shall be 10 °C to 30 °C. No constituent value may be displayed when the temperature range is exceeded. An appropriate error message shall be displayed when the temperature of the analyzer is outside its specified operating range.
- (b) The constituent range at the moisture basis specified in Table N.1.1. Constant Moisture Basis for Type Evaluation and Field Inspections shall be specified for each grain or seed for which the analyzer is to be used. A constituent value may be displayed when the constituent range is exceeded if accompanied by a clear indication that the constituent range has been exceeded.
(Amended 2001)
- (c) For whole grain analyzers only, the temperature range shall be specified for each grain or seed for which an analyzer is to be used. The minimum temperature range for each grain shall be 10 °C to 30 °C. No constituent value may be displayed when the temperature range is exceeded. An appropriate error message shall be displayed when the temperature of the grain sample exceeds the temperature range for the grain. The requirements of this subsection (c) are not applicable to ground grain analyzers.
- (d) For whole grain analyzers, the maximum allowable difference in temperature between the instrument environment (ambient temperature) and the sample for which an accurate constituent determination can be made shall be specified. The minimum temperature range shall cover at least 10 °C. No constituent value may be displayed when the maximum allowable temperature difference is exceeded. An appropriate error message shall be displayed when the difference between the ambient temperature

and the sample temperature exceeds the specified difference. The requirements of this subsection (d) are not applicable to ground grain analyzers.
[Nonretroactive and effective as of January 1, 2003]

S.1.4. Operating Temperature.

- (a) *An analyzer shall not display or record any usable values until the internal operating temperature necessary to meet tolerance requirements has been attained, or the analyzer shall bear a conspicuous statement adjacent to the indication stating that the analyzer shall be turned on for a time period specified by the manufacturer prior to use.*
- (b) *If an instrument does not meet tolerance requirements because there is an upper internal operating temperature limit that could be exceeded when operating within the ambient temperature range specified by the manufacturer, then a means of sensing and indicating an over-temperature condition must be provided.*

[Nonretroactive as of January 1, 2003]

S.1.5. Value of Smallest Unit. – *The display shall permit constituent value determination to both 0.01 % and 0.1 % resolution. The 0.1 % resolution is for commercial transactions; the 0.01 % resolution is for calibration purposes only, not for commercial purposes.*

[Nonretroactive as of January 1, 2003]

S.2. Design of NIR Analyzers.

S.2.1. Minimum Sample Size. – *Analyzers shall be designed to measure constituent values of representative size grain samples. The minimum allowable sample size used in analysis shall be 20 g.*
[Nonretroactive as of January 1, 2003]

S.2.2. Electric Power Supply.

S.2.2.1. Power Supply, Voltage and Frequency. – *An analyzer that operates using alternating current must perform within tolerance requirements over the line voltage range 100 V to 130 V and over the frequency range of 59.5 Hz to 60.5 Hz.*
[Nonretroactive as of January 1, 2003]

S.2.2.2. Power Interruption. – *A power interruption shall not cause an indicating or recording element to display or record any values outside the applicable tolerance limits.*
[Nonretroactive as of January 1, 2003]

S.2.3. Level Indicating Means. – *Analyzers shall be equipped with a level indicator and leveling adjustments if its performance is changed by an amount greater than the tolerance requirement when the instrument is moved from a level position into a position that is out of level in any upright direction by up to 5 % (approximately three degrees). The level-indicating means shall be readable without removing any instrument parts requiring a tool.*
[Nonretroactive as of January 1, 2003]

S.2.4. Environmental Conditions. – *Instrument optics and electronics must be protected from exposure to dust by either sealing these areas or by protecting them with a dust filtration system suitable for the removal of air-borne grain dust.*
[Nonretroactive as of January 1, 2003]

S.2.5. Calibration Transfer and Verification.

S.2.5.1. Calibration Transfer. – *The instrument hardware/software design and calibration procedures shall permit calibration development and the mathematical transfer of calibrations between instruments of like models.*

Note: Only the manufacturer or the manufacturer's designated service agency may make calibration transfer or slope adjustments on near-infrared grain analyzers and, except for instrument failure and repair, only during a prescribed period of time during the year. This does not preclude the possibility of the operator installing the manufacturer-specified calibration constants or standardization parameters under the instructions of the manufacturer or the manufacturer's designated service agency. Nor does it preclude operator bias adjustments when made under the conditions specified in UR.2.8. Slope and Bias Adjustments.

[Nonretroactive and effective as of January 1, 2003]

(Note added 1995) (Amended 1995)

S.2.5.2. Calibration Version. – An instrument must be capable of displaying either calibration constants, a unique calibration name, or a unique calibration version number for use in verifying that the latest version of the calibration is being used to make constituent determinations, and that the appropriate instrument settings have been made for the calibration being used.

[Nonretroactive as of January 1, 2003]

(Amended 2001)

S.2.5.3. Calibration Corruption. – If calibration constants are digitally stored in an electronically alterable form, the analyzer shall be designed to make automatic checks to detect corruption of calibration constants. An error message must be displayed if calibration constants have been electronically altered.

[Nonretroactive as of January 1, 2003].

S.2.6. Provision for Sealing. – An event logger is required in the device; it must include an event counter (000 to 999), the parameter ID, the date and time of the change, and the new value of the parameter (for calibration changes consisting of multiple constants, the calibration version number may be used rather than the calibration constants.)

A printed copy of the information must be available through the device or through another on-site device. The event logger shall have a capacity to retain records equal to 25 times the number of sealable parameters in the device, but not more than 1000 records are required. (**Note:** Does not require 1000 changes to be stored for each parameter.)

[Nonretroactive as of January 1, 2003]

(Amended 1997)

S.3. Accessory Equipment. – When the operating instructions for an NIR analyzer require accessory equipment separate from and external to the analyzer, such equipment shall be appropriate and complete for the measurement. [Nonretroactive as of January 1, 2003]

S.3.1. Grinders. – The make and model of grinder used for ground grain NIR analyzers must be specified by the manufacturer and required as auxiliary equipment in the determination of constituent values for applicable grain types.

[Nonretroactive as of January 1, 2003]

S.4. Operating Instructions and Use Limitations. – The manufacturer shall furnish operating instructions for the device and accessories that include complete information concerning the accuracy, sensitivity, and use of accessory equipment necessary in obtaining a constituent value. Operating instructions shall include the following information:

- (a) name and address or trademark of the manufacturer;
- (b) the type or design of the device for which the operating instructions are intended to be used;
- (c) date of issue;

- (d) *the kind or classes of grain or seed for which the device is designed to measure constituent values; and*
- (e) *the limitations of use, including but not limited to constituent range, grain or seed temperature, kind or class of grain or seed, instrument temperature, voltage and frequency ranges, electromagnetic interferences, and necessary accessory equipment.*

[Nonretroactive as of January 1, 2003]

N. Notes

N.1. Testing Procedures.

N.1.1. Field Inspection. – Whole grain samples shall be used as the official field inspection standards. Five samples per grain type or class shall be used to check instrument performance. Each sample will be analyzed once. One of the samples will be analyzed an additional four times to test instrument repeatability. For ground grain instruments, the ground sample will be repacked four times. A new grind is not required. Test results must be converted to the standard moisture bases shown in Table N.1.1. Constant Moisture Basis for Type Evaluation and Field Inspection before applying the tolerances of Table T.2. Acceptance and Maintenance Tolerances for NIR Grain Analyzers. Test results on whole grain analyzers that produce results on an “as is” basis without displaying or recording a moisture value shall be converted to the standard moisture bases shown in Table N.1.1. Constant Moisture Basis for Type Evaluation and Field Inspection using sample moisture values determined with the facility’s moisture meter (which must be certified for commercial use).

(Amended 2001)

| <i>Table N.1.1. Constant Moisture Basis for Type Evaluation and Field Inspection</i> | | |
|---|-----------------------------------|------------------------|
| <i>Grain Type or Class</i> | <i>Constituents(s)</i> | <i>Moisture Basis</i> |
| <i>Durum Wheat, Hard Red Spring Wheat, Hard Red Winter Wheat, Hard White Wheat, Soft Red Winter Wheat, Soft White Wheat</i> | <i>Protein</i> | <i>12 %</i> |
| <i>Soybeans</i> | <i>Protein Oil</i> | <i>13 %</i> |
| <i>Two-rowed Barley Six-rowed Barley</i> | <i>Protein</i> | <i>0 % (dry basis)</i> |
| <i>Corn</i> | <i>Protein Oil Starch</i> | <i>0 % (dry basis)</i> |

[Nonretroactive as of January 1, 2003]

(Table Added 2001)

Constituent values shall be assigned to test samples by the Grain Inspection, Packers and Stockyards Administration (GIPSA). Tolerances shall be applied to individual sample measurements, the average of individual measurements on each of the five test samples, and the maximum difference (range) in results for five analyses on one of the test samples.

(Amended 2001)

N.1.2. Standard Reference Samples. – Reference samples used for field inspection purposes shall be clean and selected to reasonably represent the constituent range. These samples shall be selected such that the difference between constituent values obtained using the GIPSA standard reference method and an official GIPSA NIR grain analyzer does not exceed one-half of the acceptance tolerance shown in Table T.2. Acceptance and Maintenance Tolerances for NIR Grain Analyzers for individual test samples or 0.375 times the acceptance tolerance shown for the average of five samples.

(Amended 2001 and 2003)

T. Tolerances

T.1. To Underregistration and to Overregistration. – The tolerances hereinafter prescribed shall be applied to errors of underregistration and errors of overregistration and shall be based on constituent values expressed at the moisture bases shown in Table N.1.1. Constant Moisture Basis for Type Evaluation and Field Inspection.

(Amended 2001)

T.2. Tolerance Values. – Acceptance and maintenance tolerances shall be equal. Tolerances for individual samples and the average for five samples are as shown in Table T.2. Acceptance and Maintenance Tolerances for NIR Grain Analyzers.

| Table T.2. Acceptance and Maintenance Tolerances for NIR Grain Analyzers | | | | |
|--|-------------|------------------------------|------------------------------------|----------------------------------|
| Type or Class of Grain | Constituent | Individual Samples (percent) | Average for Five Samples (percent) | Range for Five Retests (percent) |
| Durum Wheat, Hard Red Spring Wheat, Hard Red Winter Wheat, Hard White Wheat, Soft Red Winter Wheat, Soft White Wheat | protein | 0.60 | 0.40 | 0.40 |
| Soybeans | protein | 0.80 | 0.60 | 0.60 |
| | oil | 0.70 | 0.50 | 0.50 |
| Two-rowed Barley Six-rowed Barley | protein | 0.70 | 0.50 | 0.50 |
| Corn | protein | 0.80 | 0.60 | 0.60 |
| | oil | 0.70 | 0.50 | 0.50 |
| | starch | 1.00 | 0.80 | 0.80 |

(Amended 2001)

UR. User Requirements

UR.1. Installation Requirements. – The NIR analyzer shall be installed in an environment within the range of temperature and/or other environmental factors specified in the operating manual.

UR.2. User Requirements.

UR.2.1. Operating Instructions. – The operating instructions for the NIR analyzer shall be readily available to the user, service technician, and weights and measures official at the place of installation. It shall include a list of accessory equipment if any are required to obtain constituent values, and the type or class of grain to be measured with the NIR analyzer. If an NIR analyzer has the capability, the user is permitted to select the moisture basis to be used on any measurement.

(Amended 2001)

UR.2.2. Other Devices Not Used for Commercial Measurement. – If there are other NIR analyzers on the premises not used for trade or determining other charges for services, these devices shall be clearly and conspicuously marked “Not for Use in Trade or Commerce.”

UR.2.3. Printed Tickets.

- (a) *Printed tickets shall be free from any previous indication of constituent or grain type selected. The printed ticket shall indicate constituent values and the moisture basis associated with each constituent value (except moisture). If the analyzer is calibrated to display results on an “as is” moisture basis and does NOT display or record a moisture value, the ticket must clearly indicate that results are expressed on an “as is” moisture basis.*

(Amended 2001)

- (b) *The customer shall be given a printed ticket showing the date, grain type or class, constituent results, and calibration version identification. If the analyzer converts constituent results to a manually entered moisture basis, the “native” concentration and the “native” moisture basis must appear on the printed ticket in addition to the converted results and the manually entered moisture basis. If the manually entered moisture basis is intended to be the moisture value for an “as is” constituent concentration measurement, that moisture value must have been obtained on the same sample and must have been measured on a moisture meter certified for commercial use. The information presented on the ticket shall be arranged in a consistent and unambiguous manner. The ticket shall be generated by the near-infrared grain analyzer system.*

[Nonretroactive as of January 1, 2003]

(Amended 2001)

UR.2.4. Grinders. – Place grinders in a separate room from the NIR analyzer to avoid instrument contamination. If a separate room is not available, the grinder may be in the same room with the NIR analyzer provided the grinder is not placed within one meter of the air intake on the NIR.

UR.2.5. Sampling. – Samples shall be obtained by following appropriate sampling methods and equipment. These include, but are not limited to grain probes of appropriate length used at random locations in the bulk, the use of a pelican sampler, or other techniques and equipment giving equivalent results. The sample shall be taken such that it is representative of the lot. If an NIR analyzer permits user entry of the moisture value for an “as is” constituent measurement, that moisture value must have been obtained on the same sample and must have been measured on a moisture meter certified for commercial use.

(Amended 2001)

UR.2.6. Level Condition. – If equipped with a level indicator, an analyzer shall be maintained in a level condition.

UR.2.7. Operating Limitation. – Constituent determinations shall not be made when the difference in temperatures between the grain sample and the instrument environment (ambient temperature) exceeds manufacturer recommendations.

UR.2.8. Slope and Bias Adjustments. – Bias changes shall be made only on the basis of tests run on a current set of Standard Reference Samples (SRS) traceable to GIPSA Master Instruments.⁴³ A written explanation and record of all calibration changes, including those changes made by a manufacturer or the manufacturer’s designated service agency, shall be maintained. The log shall indicate the date and magnitude of changes in bias and slope constants and the instrument serial number. A Calibration Adjustment Data Sheet for each log entry shall be available for inspection upon request by the field inspector. Data Sheets shall be retained by the user for a period of no less than 18 months following any calibration adjustment. The Data Sheet must show: date of test and adjustment, serial number of the instrument, calibration identification, the nature of the adjustment, the unique identification number and source of sample sets used, and, for each sample in the set, reference values, initial instrument results (except in the cases of instrument failure and repair), and instrument results after calibration adjustment or instrument repair.

⁴³ Established error must be known.

(Amended 1995)

MARKUP COPY

Section 5.58. Multiple Dimension Measuring Devices

A. Application

A.1. General. – This code applies to ~~near infrared (NIR) grain analyzers; that is,~~dimension and volume measuring devices used to indicate the constituent values (other than moisture content) of grain using near infrared reflectance or

~~(a) transmittance technology. These instruments~~

analyze either whole grain or ground grain samples. The code consists of general requirements applicable to all NIR analyzers and specific requirements applicable only to certain types of NIR analyzers, grain types, or grain constituents. In addition to ~~meeting for determining~~ the requirements of this code, a whole grain NIR analyzer that displays a measured moisture value must also comply with the requirements of the Grain Moisture Meters Code.

(Added 2001)

A.2. Exceptions. – This code does not apply to devices used for in motion measurement of grain constituent values.

A.3. Calibrations. – The National Type Evaluation Program (NTEP) Certificate of Conformance (CC) shall indicate the native moisture basis of each calibration. The “native” moisture basis is the default moisture basis dimensions and/or volume of the sealable constituent calibration (or constituent calibration pair when a non displayed moisture calibration is also involved). If an NIR analyzer uses a self-generated moisture measurement internally but does NOT display or record a moisture value, the moisture calibration shall be considered to be a part of the constituent calibration. For such calibrations, the CC shall state: “Includes non displayed moisture calibration.” Changes to any part of such calibrations shall require changes to the CC objects for the purpose of calculating freight, storage, or postal charges based on the dimensions and/or volume occupied by the object. A multiple dimension measuring device:

(a) is generally used to measure hexahedron-shaped objects; and

(Added 2001+2008)

A.4. Additional Code Requirements. (b) may be used to measure irregularly-shaped objects.

(Added 2008)

(Amended 2008)

A.2. Other Devices Designed to Make Multiple Measurement Automatically to Determine a Volume. = Insofar as they are clearly applicable, the provisions of this code apply also to devices designed to make multiple measurements automatically to determine a volume for other applications as defined by Section 1.10. General Code paragraph G-A.1. Commercial and Law-Enforcement Equipment.

A.3. Additional Code Requirements. – In addition to the requirements of this code, ~~Near Infrared Grain Analyzers~~Multiple Dimension Measuring Devices shall meet the requirements of Section 1.10. General Code.

A.4. Exceptions. – This code does not apply to:

(a) devices designed to indicate automatically (with or without value-computing capabilities) the length of fabric passed through the measuring elements (also see Section 5.50. for Fabric-Measuring Devices);

(b) devices designed to indicate automatically the length of cordage, rope, wire, cable, or similar flexible material passed through the measuring elements (also see Section 5.51. for Wire- and Cordage-Measuring Devices); or

- (c) any linear measure, measure of length, or devices used to measure individual dimensions for the purpose of assessing a charge per unit of measurement of the individual dimension (also see Section 5.52. for Linear Measures).

A.5. Type Evaluation. – The National Type Evaluation Program (NTEP) will accept for type evaluation only those devices that comply with all requirements of this code.

S. Specifications

S.1. Design of Indicating, and Recording, ~~and Measuring~~ Elements and of Recorded Representations.

S.1.1. Zero or Ready Indication.

(a) Provision shall be made to indicate or record either a zero or ready condition.

(b) A zero or ready condition may be indicated by other than a continuous digital zero indication, provided that an effective automatic means is provided to inhibit a measuring operation when the device is in an out-of-zero or non-ready condition.

S.1.2. Digital Indications. – Indicated and Recording Elements.

~~(h) Analyzers shall be equipped with a digital indicating element.~~

~~The minimum height for the digits used to display constituent~~**recorded** values shall be ~~10 mm~~**presented digitally.**

~~(i) Analyzers shall be equipped with a communication interface that permits interfacing with a recording element and transmitting the date, grain type or class, constituent values, the moisture basis for each constituent value (except moisture), and calibration version identification. If the analyzer converts constituent results to a manually entered moisture basis, the “native” concentration and the “native” moisture basis must appear on the printed ticket in addition to the converted results and the manually entered moisture basis.~~

~~(Amended 2001 and 2003)~~

~~(j) A digital indicating element shall not display, and a recording element shall not record, any constituent value before the end of the measurement cycle.~~

~~(k) Constituent content shall be recorded and displayed as percent of total mass at the specified moisture basis. The moisture basis shall also be recorded and displayed for each constituent content result (except moisture). If a whole grain analyzer that is calibrated to display results on an “as is” moisture basis does NOT display or record a moisture value, it must clearly indicate that results are expressed on an “as is” moisture basis. Ground grain analyzers must ALWAYS display and record a moisture measurement for “as is” content results (except moisture).~~

~~(Amended 2001 and 2003)~~

~~(l) An analyzer shall not display or record any constituent value that is beyond the operating range of the device unless the constituent value representation includes a clear error indication (and recorded error message with the recorded representation).~~

~~(m) If an NIR analyzer is used to determine a moisture value, either to determine the moisture of an “as is” constituent content measurement or to convert from one moisture basis to another, the moisture measurement must be concurrent with the measurement of other constituents.~~

- (h) ~~— If the analyzer incorporates a built-in printer, or if a printer is available as an accessory to the analyzer, the information appearing on the printout shall be arranged in a consistent and unambiguous manner.~~

(Added 2003)

[Nonretroactive as of January 1, 2003]

(Added 2001)

S.1.2. ~~Selecting and Recording Grain Class and Constituent.~~ ~~Provision shall be made for selecting and recording the type or class or multi-class group of grain and the constituent(s) to be measured. The means to select the grain type or class or multi-class group and the constituent(s) shall be readily visible and the type or class or multi-class group of grain and the constituent(s) selected shall be clearly and definitely identified in letters (such as HRWW, HRSW, WHEAT, etc., or PROT, etc.). A symbol to identify the display of the type or class or multi-class group of grain and constituent(s) selected is permitted provided that it is clearly defined adjacent to the display. Minimum acceptable abbreviations are listed in Table S.1.2. Grain Types and Multi-Class Groups Considered for Type Evaluation and Calibration and Their Minimum Acceptable Abbreviations.~~

[Nonretroactive as of January 1, 2003]

~~If more than one calibration is included for a given grain type, the calibrations must be clearly distinguished from one another.~~

[Nonretroactive as of January 1, 2004]

(Amended 2003 and 2007)

S.1.3. Negative Values. – Except when in the tare mode, negative values shall not be indicated or recorded.

S.1.4. Dimensions Indication. – If in normal operation the device indicates or records only volume, a testing mode shall be provided to indicate dimensions for all objects measured.

S.1.5. Value of Dimension/Volume Division Units. – The value of a device division “d” expressed in a unit of dimension shall be presented in a decimal format with the value of the division expressed as:

(a) 1, 2, or 5;

(b) a decimal multiple or submultiple of 1, 2, or 5; or

(c) a binary submultiple of a specific inch-pound unit of measure.

Examples: device divisions may be 0.01, 0.02, 0.05; 0.1, 0.2, or 0.5; 1, 2, or 5; 10, 20, 50, or 100; 0.5, 0.25, 0.125, 0.0625, etc.

S.1.5.1. For Indirect Sales. – In addition to the values specified in S.1.5. Value of Dimension/Volume Division Units, the value of the division may be 0.3 inch and 0.4 inch.

S.1.5.2. Devices Capable of Measuring Irregularly-Shaped Objects. – For devices capable of measuring irregularly shaped objects, the value of the division size (d) shall be the same for the length axis (x) and the width axis (y) and may be different for the height axis (z), provided that electronic rotation of the object to determine the smallest hexahedron is calculated in only a two-dimension horizontal plane, retaining the stable side plane as the bottom of the hexahedron.

(Added 2008)

S.1.6. Customer Indications and Recorded Representations. – Multiple dimension measuring devices or systems must provide information as specified in Table S.1.6. Required Information to be Provided by Multiple Dimension Measuring Systems. As a minimum, all devices or systems must be able to meet either column I or column II in Table S.1.6. Required Information to be Provided by Multiple Dimension Measuring Systems.

(Amended 2004)

MARKUP COPY

| Table S.1.26. | | | | |
|--|--|---|----------------------|--|
| <u>Grain Types and Multi-Class Groups Considered for Type Evaluation and Calibration and Their Minimum Acceptable Abbreviations</u> | | | | |
| <u>Grain Type</u> Information | Grain Class Column I ¹ | Minimum Acceptable Abbreviation Column II ¹ | | Column III |
| | Two-Rowed Barley Provided by device | TRB Provided by invoice or other means | | Provided by invoice or other means as specified in contractual agreement |
| | Six-Rowed Barley | Customer present | Customer not present | |
| <u>1. Device identification</u> ² | All Class Barley* <u>D or P</u> | P | P | P or A |
| <u>2. Error message (when applicable)</u> | — <u>D or P</u> | P | N/A | N/A |
| <u>3. Hexahedron dimensions</u> ³ | — <u>D or P</u> | P | P | P or A |
| <u>4. Hexahedron volume (if used)</u> ³ | <u>D or P</u> | P | P | P or A |
| <u>5. Actual weight (if used)</u> ³ | <u>D or P</u> | P | P | P or A |
| <u>6. Tare (if used)</u> ³ | <u>D or P</u> | N/A | N/A | N/A |
| <u>7. Hexahedron measurement statement</u> ⁴ | <u>D or P or M</u> | P | P | P or G |
| <p>A = AVAILABLE UPON REQUEST BY CUSTOMER⁵ D = DISPLAYED G = PUBLISHED GUIDELINES OR CONTRACTS M = MARKED N/A = NOT APPLICABLE P = PRINTED or PAI Class Wheat*RECORDED IN A MEMORY DEVICE and AVAILABLE UPON REQUEST BY CUSTOMER⁵</p> <p>Notes: ¹ As a minimum all devices or systems must be able to meet either column I or column II. ² This is only required in systems where more than one device or measuring element is being used. ³ Some devices or systems may not utilize all of these values; however as a minimum either hexahedron dimensions or hexahedron volume must be displayed or printed. ⁴ This is an explanation that the dimensions and/or volume shown are those of the smallest hexahedron in which the object that was measured may be enclosed rather than those of the object itself. ⁵ The information “available upon request by customer” shall be retained by the party having issued the invoice for at least 30 calendar days after the date of invoicing.</p> | | | | |
| | Durum Wheat | DURW | | |
| | Hard Red Spring Wheat | HRSW | | |
| | Hard Red Winter Wheat | HRWW | | |

| | | |
|-------------------------------|------------------------|----------|
| | Hard White Wheat | HDWW |
| | Soft Red Winter Wheat | SRWW |
| | Soft White Wheat | SWW |
| | Wheat Excluding Durum* | WHTEXDUR |
| (Table Amended 2001 and 2007) | | |

S.1.3. — Operating Range. — An analyzer shall automatically and clearly indicate when the operating range of the device has been exceeded. The statement of the operating range shall be specified in the operator's manual and shall operate as follows:

- (e) ~~The ambient temperature range over which the analyzer may be used and still comply with the applicable requirements shall be specified. The minimum temperature range shall be 10 °C to 30 °C. No constituent value may be displayed when the temperature range is exceeded. An appropriate error message shall be displayed when the temperature of the analyzer is outside its specified operating range.~~
- (f) ~~The constituent range at the moisture basis specified in Table N.1.1. Constant Moisture Basis for Type Evaluation and Field Inspections shall be specified for each grain or seed for which the analyzer is to be used. A constituent value may be displayed when the constituent range is exceeded if accompanied by a clear indication that the constituent range has been exceeded.~~

(Amended 2001**2004**)

- (g) ~~For whole grain analyzers only, the temperature range shall be specified for each grain or seed for which an analyzer is to be used. The minimum temperature range for each grain shall be 10 °C to 30 °C. No constituent value may be displayed when the temperature range is exceeded. An appropriate error message shall be displayed when the temperature of the grain sample exceeds the temperature range for the grain. The requirements of this subsection (c) are not applicable to ground grain analyzers.~~
- (h) ~~For whole grain analyzers, the maximum allowable difference in temperature between the instrument environment (ambient temperature) and the sample for which an accurate constituent determination can be made shall be specified. The minimum temperature range shall cover at least 10 °C. No constituent value may be displayed when the maximum allowable temperature difference is exceeded. An appropriate error message shall be displayed when the difference between the ambient temperature and the sample temperature exceeds the specified difference. The requirements of this subsection (d) are not applicable to ground grain analyzers.~~

[Nonretroactive and effective as of January 1, 2003]

S.1.4S.1.7. Minimum Lengths. – Except for entries of tare, the minimum length to be measured by a device is 12 divisions. The manufacturer may specify a longer minimum length.

S.1.8. Indications Below Minimum and Above Maximum. – When objects are smaller than the minimum dimensions identified in paragraph S.1.7. Minimum Lengths or larger than any of the maximum dimensions plus 9 d, and/or maximum volume marked on the device plus 9 d, or when a combination of dimensions for the object being measured exceeds the measurement capability of the device, the indicating or recording element shall either:

- (a) not indicate or record any usable values; or
- (b) identify the indicated or recorded representation with an error indication.

(Amended 2004)

S.1.9. Operating Temperature.

~~(c) An analyzer shall not display or record any usable values until the internal operating temperature necessary to meet tolerance requirements has been attained, or the analyzer shall bear a conspicuous statement adjacent to the indication stating that the analyzer shall be turned on for a time period specified by the manufacturer prior to use.~~

~~(d) If an instrument does not meet tolerance requirements because there is an upper internal operating temperature limit that could be exceeded when operating within the ambient temperature range specified by the manufacturer, then a means of sensing and indicating an over temperature condition must be provided.~~

~~[Nonretroactive as of January 1, 2003]~~

~~S.1.5. Value of Smallest Unit. The display shall permit constituent value determination to both 0.01 % and 0.1 % resolution. The 0.1 % resolution is for commercial transactions; the 0.01 % resolution is for calibration purposes only, not for commercial purposes.~~

~~[Nonretroactive as of January 1, 2003]~~

S.2. Design of NIR Analyzers.

~~S.2.1. Minimum Sample Size. Analyzers shall be designed to measure constituent values of representative size grain samples. The minimum allowable sample size used in analysis shall be 20 g.~~

~~[Nonretroactive as of January 1, 2003]~~

~~S.2.2. Electric Power Supply.~~

~~S.2.2.1. Power Supply, Voltage and Frequency. An analyzer that operates using alternating current must perform within tolerance requirements over the line voltage range 100 V to 130 V and over the frequency range of 59.5 Hz to 60.5 Hz.~~

~~[Nonretroactive as of January 1, 2003]~~

~~S.2.2.2. Power Interruption. A power interruption shall not cause an An indicating or recording element to display or **shall not indicate nor** record any usable values outsideuntil the applicable tolerance limits.~~

~~[Nonretroactive as of January 1, 2003]~~

~~S.2.3. Level Indicating Means. Analyzers shall be equipped **withoperating temperature necessary for accurate measuring and** a level indicator and leveling adjustments if its performance is changed by an amount greater than the tolerance requirement when the instrument is moved from a level position into a position that is out of level in any upright direction by up to 5 % (approximately three degrees). The level-indicating means shall be readable without removing any instrument parts requiring a tool.~~

~~[Nonretroactive as of January 1, 2003]~~

~~S.2.4. Environmental Conditions. Instrument optics and electronics must be protected from exposure to dust by either sealing these areas or by protecting them with a dust filtration system suitable for the removal of air borne grain dust.~~

~~[Nonretroactive as of January 1, 2003]~~

~~S.2.5. Calibration Transfer and Verification.~~

~~S.2.5.1. Calibration Transfer. The instrument hardware/software design and calibration procedures shall permit calibration development and the mathematical transfer of calibrations between instruments of like models.~~

~~Note: Only the manufacturer or the manufacturer's designated service agency may make calibration transferstable zero reference or slope adjustments on near infrared grain analyzers and, except for instrument~~

~~failure and repair, only during a prescribed period of time during the year. This does not preclude the possibility of the operator installing the manufacturer specified calibration constants or standardization parameters under the instructions of the manufacturer or the manufacturer's designated service agency. Nor does it preclude operator bias adjustments when made under the conditions specified in UR.2.8. Slope and Bias Adjustments~~**ready condition has been attained.**

[Nonretroactive and effective as of January 1, 2003]

(Note added 1995) (Amended 1995)

S.2.5.2. — Calibration Version.— An instrument must be capable of displaying either calibration constants, a unique calibration name, or a unique calibration version number for use in verifying that the latest version of the calibration is being used to make constituent determinations, and that the appropriate instrument settings have been made for the calibration being used.

[Nonretroactive as of January 1, 2003]

(Amended 2001)

S.2.5.3. — Calibration Corruption.— If calibration constants are digitally stored in an electronically alterable form, the analyzer shall be designed to make automatic checks to detect corruption of calibration constants. An error message must be displayed if calibration constants have been electronically altered.

[Nonretroactive as of January 1, 2003].

S.2.6. — Provision for Sealing.— An event logger is required in the device; it must include an event counter (000 to 999), the parameter ID, the date and time of the change, and the new value of the parameter (for calibration changes consisting of multiple constants, the calibration version number may be used rather than the calibration constants.)

A printed copy of the information must be available through the device or through another on-site device. The event logger shall have a capacity to retain records equal to 25 times the number of sealable parameters in the device, but not more than 1000 records are required. (Note: Does not require 1000 changes to be stored for each parameter.)

[Nonretroactive as of January 1, 2003]

(Amended 1997)

S.3. — Accessory Equipment.— When the operating instructions for an NIR analyzer require accessory equipment separate from and external to the analyzer, such equipment shall be appropriate and complete for the measurement.

[Nonretroactive as of January 1, 2003]

S.3.1. Grinders.— The make and model of grinder used for ground grain NIR analyzers must be specified by the manufacturer and required as auxiliary equipment in the determination of constituent values for applicable grain types;

[Nonretroactive as of January 1, 2003]

S.4. — Operating Instructions and Use Limitations.— The manufacturer shall furnish operating instructions for the device and accessories that include complete information concerning the accuracy, sensitivity, and use of accessory equipment necessary in obtaining a constituent value. Operating instructions shall include the following information:

(f) name and address or trademark of the manufacturer;

(g) the type or design of the device for which the operating instructions are intended to be used;

(h) date of issue;

(i) the kind or classes of grain or seed for which the device is designed to measure constituent values; and

~~(j) the limitations of use, including but not limited to constituent range, grain or seed temperature, kind or class of grain or seed, instrument temperature, voltage and frequency ranges, electromagnetic interferences, and necessary accessory equipment.
[Nonretroactive as of January 1, 2003]~~

N. Notes

N.1. Testing Procedures.

~~N.1.(Amended 2004)~~

~~1. **Field Inspection.** Whole grain samples shall be used as the official field inspection standards. Five samples per grain type or class shall be used to check instrument performance. Each sample will be analyzed once. One of the samples will be analyzed an additional four times to test instrument repeatability. For ground grain instruments, the ground sample will be repacked four times. A new grind is not required. Test results must be converted to the standard moisture bases shown in Table N.1.1. Constant Moisture Basis for Type Evaluation and Field Inspection before applying the tolerances of Table T.2. Acceptance and Maintenance Tolerances for NIR Grain Analyzers. Test results on whole grain analyzers that produce results on an “as is” basis without displaying or recording a moisture value shall be converted to the standard moisture bases shown in Table N.1.1. Constant Moisture Basis for Type Evaluation and Field Inspection using sample moisture values determined with the facility’s moisture meter (which must be certified for commercial use).~~

~~(Amended 2001)~~

S.1.10. Adjustable Components. – Adjustable components shall be held securely in adjustment and, except for a zeroing mechanism (when applicable), shall be located within the housing of the element.

S.1.11. Provision for Sealing.

(a) A device shall be designed with provision(s) for applying a security seal that must be broken, or for using other approved means of providing security (e.g., data change audit trail available at the time of inspection), before any change that detrimentally affects the metrological integrity of the device can be made to any measuring element.

(b) Audit trails shall use the format set forth in Table S.1.11. Categories of Devices and Methods of Sealing for Multiple Dimension Measuring Systems.

| Table S.1.11. Categories of Devices and Methods of Sealing for Multiple Dimension Measuring Systems | |
|---|---|
| Categories of Devices | Methods of Sealing |
| Category 1: <u>No remote configuration.</u> | <u>Seal by physical seal or two event counters: one for calibration parameters and one for configuration parameters.</u> |
| Category 2: <u>Remote configuration capability, but access is controlled by physical hardware.</u> <u>Device shall clearly indicate that it is in the remote configuration mode and record such message if capable of printing in this mode.</u> | Table N.1.1. <u>Constant Moisture Basis for Type Evaluation and Field Inspection</u>The hardware enabling access for remote communication must be at the device and sealed using a physical seal or two event counters: one for calibration parameters and one for configuration parameters. |

| Grain Type or Class | Constituents(s) | Moisture Basis |
|---|--|-----------------|
| Durum Wheat, Hard Red Spring Wheat, Hard Red Winter Wheat, Hard White Wheat, Soft Red Winter Wheat, Soft White Wheat | Protein | 12 % |
| Soybeans | Protein Oil | 13 % |
| Two rowed Barley Six rowed Barley | Protein | 0 % (dry basis) |
| Corn | Protein Oil Starch | 0 % (dry basis) |
| <u>Category 3: Remote configuration capability access may be unlimited or controlled through a software switch (e.g., password).</u> | [Nonretroactive as of January 1, 2003] <u>(Table Added 2001) An event logger is required in the device; it must include an event counter (000 to 999), the parameter ID, the date and time of the change, and the new value of the parameter. A printed copy of the information must be available through the device or through another on-site device. The event logger shall have a capacity to retain records equal to 10 times the number of sealable parameters in the device, but not more than 1000 records are required. (Note: Does not require 1000 changes to be stored for each parameter.)</u> | |

Constituent values shall be assigned to test samples by the Grain Inspection, Packers and Stockyards Administration (GIPSA). Tolerances shall be applied to individual sample measurements, the average of individual measurements on each of the five test samples, and the maximum difference (range) in results for five analyses on one of the test samples.

S.2. Design of Zero and Tare.

S.2.1. Zero or Ready Adjustment. – A device shall be equipped with means by which the zero reference or ready condition can be adjusted, or the zero reference or ready condition shall be automatically maintained. The zero reference or ready control circuits shall be interlocked so that their use is prohibited during measurement operations.

S.2.2. Tare. – The tare function shall operate only in a backward direction (that is, in a direction of underregistration) with respect to the zero reference or ready condition of the device. The value of the tare division or increment shall be equal to the division of its respective axis on the device. There shall be a clear indication that tare has been taken.

S.3. Systems with Two or More Measuring Elements. – A multiple dimension measuring system with a single indicating or recording element, or a combination indicating-recording element, that is coupled to two or more measuring elements with independent measuring systems, shall be provided with means to prohibit the activation of any measuring element (or elements) not in use, and shall be provided with automatic means to indicate clearly and definitely which measuring element is in use.

Note: This requirement does not apply to individual devices that use multiple emitters/sensors within a device in combination to measure objects in the same measurement field.

(Amended 2001**2004**)

N.1.2. Standard Reference Samples. Reference samples used for field inspection purposes shall be clean and selected to reasonably represent the constituent range. These samples shall be selected such that the difference between constituent values obtained using the GIPSA standard reference method and an official GIPSA NIR grain analyzer does not exceed one half of the acceptance tolerance shown in

~~Table T.2. Acceptance and Maintenance Tolerances for NIR Grain Analyzers for individual test samples or 0.375 times the acceptance tolerance shown for the average of five samples.
(Amended 2001 and 2003)~~

T. — Tolerances

~~**T.1. To Underregistration and to Overregistration.**— The tolerances hereinafter prescribed shall be applied to errors of underregistration and errors of overregistration and shall be based on constituent values expressed at the moisture bases shown in Table N.1.1. Constant Moisture Basis for Type Evaluation and Field Inspection.
(Amended 2001)~~

~~**T.2. Tolerance Values.**— Acceptance and maintenance tolerances shall be equal. Tolerances for individual samples and the average for five samples are as shown in Table T.2. Acceptance and Maintenance Tolerances for NIR Grain Analyzers.~~

~~**S.4. Marking Requirements.** (Also see also G-S.1. Identification, G-S.4. Interchange or Reversal of Parts, G-S.5.2.5. Permanence, G-S.6. Marking Operational Controls, Indications, and Features, G-S.7. Lettering, G-UR.2.1.1. Visibility of Identification, and G-UR.3.1. Method of Operation.)~~

~~**S.4.1. Multiple Dimension Measuring Devices, Main Elements, and Components of Measuring Devices.**— Multiple dimension measuring devices, main elements of multiple dimension measuring devices when not contained in a single enclosure for the entire dimension/volume measuring device, and other components shall be marked as specified in Table S.4.1.a. and explained in the accompanying notes, Table S.4.1.b. Multiple Dimension Measuring Systems Notes for Table S.4.1.a.~~

| Table T-2S.4.1.a. | | | | |
|---|---|--|--|--|
| Acceptance and Maintenance Tolerances for NIR Grain Analyzers Marking Requirements for Multiple Dimension Measuring Systems | | | | |
| To Be Marked With ↓ | Multiple Dimension Measuring Equipment | | | |
| | Multiple Dimension Measuring Device and Indicating Element in Same Housing | Indicating Element not Permanently Attached to Multiple Dimension Measuring Element | Multiple Dimension Measuring Element not Permanently Attached to the Indicating Element | Other Equipment (1) |
| <u>Manufacturer's ID</u> | x | x | x | x |
| <u>Model Designation</u> | x | x | x | x |
| <u>Serial Number and Prefix</u> | x | x | x | x (2) |
| <u>Certificate of Conformance Number (8)</u> | x | x | x | x (8) |
| <u>Minimum and Maximum Dimensions for Each Axis (3)</u> | x | x | x | |
| Value of Grain Measuring Division, d (for each axis and range) | Constituent x | Individual Samples (percent) x | Average for Five Samples (percent) x | Range for Five Retests (percent) x |
| Durum Wheat, Hard Red Spring Wheat, Hard Red Winter Wheat, Hard White Wheat, Soft Red Winter Wheat, Soft White Wheat <u>Temperature Limits (4)</u> | protein x | 0.60 x | 0.40 x | 0.40 |
| Soybeans Minimum & Maximum speed (5) | protein x | 0.80 x | 0.60 x | 0.60 |
| Special Application (6) | oil x | 0.70 x | 0.50 x | 0.50 |
| Two rowed Barley Six rowed Barley Limitation of Use (7) | protein x | 0.70 x | 0.50 x | 0.50 |
| Corn | protein | 0.80 | 0.60 | 0.60 |
| | oil | 0.70 | 0.50 | 0.50 |
| | starch | 1.00 | 0.80 | 0.80 |

(Amended 2001)

Table S.4.1.b.
Multiple Dimension Measuring Systems Notes for Table S.4.1.a.

1. Necessary to the dimension and/or volume measuring system, but having no effect on the measuring value, e.g., auxiliary remote display, keyboard, etc.
2. Modules without “intelligence” on a modular system (e.g., printer, keyboard module, etc.) are not required to have serial numbers.
3. The minimum and maximum dimensions (using upper or lower case type) shall be marked. For example:

| | | |
|---------|-----|-----|
| Length: | min | max |
| Width: | min | max |
| Height: | min | max |
4. Required if the range is other than – 10 °C to 40 °C (14 °F to 104 °F).
5. Multiple dimension measuring devices, which require that the object or device be moved relative to one another, shall be marked with the minimum and maximum speeds at which the device is capable of making measurements that are within the applicable tolerances.
6. A device designed for a special application rather than general use shall be conspicuously marked with suitable words visible to the operator and the customer restricting its use to that application.
7. Materials, shapes, structures, combination of object dimensions, speed, spacing, minimum protrusion size, or object orientations that are inappropriate for the device or those that are appropriate.
8. Required only if a Certificate of Conformance has been issued for the equipment.

(Amended 2004 and 2008)

S.4.2. Location of Marking Information. – The required marking information shall be so located that it is readily observable without the necessity of the disassembly of a part requiring the use of any means separate from the device.

N. Notes

N.1. Test Procedures.

N.1.1. General. – The device shall be tested using test standards and objects of known and stable dimensions.

N.1.2. Position Test. – Measurements are made using different positions of the test object and consistent with the manufacturer’s specified use for the device.

N.1.2.1. Irregularly-Shaped Test Object Placement. – Irregularly-shaped test objects must be measured while placed on a stable side. The rotation of the object to determine the smallest hexahedron should be calculated in a two-dimensional plane, retaining the stable side plane as the bottom of the hexahedron.

(Added 2008)

N.1.3. Disturbance Tests, Field Evaluation. – A disturbance test shall be conducted at a given installation when the presence of disturbances specified in T.6. has been verified and characterized if those conditions are considered “usual and customary.”

N.1.4. Test Object Size. – Test objects may vary in size from the smallest dimension to the largest dimension marked on the device, and for field verification examinations, shall be an integer multiple of “d.”

N.1.4.1. Test Objects. – Verification of devices may be conducted using appropriate test objects of various sizes and of stable dimensions. Test object dimensions must be known to an expanded uncertainty (coverage factor $k = 2$) of not more than one-third of the applicable device tolerance. The dimensions shall also be checked to the same uncertainty when used at the extreme values of the influence factors.

The dimension of all test objects shall be verified using a reference standard that is traceable to NIST (or equivalent national laboratory) and meet the tolerances expressed in NIST Handbook 44 Fundamental Considerations, paragraph 3.2. (i.e., one-third of the smallest tolerance applied to the device).

(Added 2004)

N.1.4.2. Irregularly-Shaped Test Objects. – For irregularly-shaped test objects, at least one angle shall be obtuse and the smallest dimension for an axis shall be equal to or greater than the minimum dimension for that axis.

(Added 2008)

(Amended 2008 and 2012)

N.1.5. Digital Zero Stability. – A zero indication change test shall be conducted on all devices which show a digital zero. After the removal of any test object, the zero indication shall not change. (Also see G-UR.4.2. Abnormal Performance.)

T. Tolerances

T.1. Design. – The tolerance for a multiple dimension measuring device is a performance requirement independent of the design principle used.

T.2. Tolerance Application.

T.2.1. Type Evaluation. – For type evaluations, the tolerance values apply to tests within the influence factor limits of temperature and power supply voltage specified in T.5.1. Temperature and T.5.2. Power Supply Voltage.

T.2.2. Subsequent Verification. – For subsequent verifications, the tolerance values apply regardless of the influence factors in effect at the time of the verification. (Also see G-N.2. Testing with Nonassociated Equipment.)

T.2.3. Multi-interval (Variable Division-Value) Devices. – For multi-interval devices, the tolerance values are based on the value of the device division of the range in use.

T.3. Tolerance Values. – The maintenance and acceptance tolerance values shall be ± 1 division.
(Amended 2004)

T.4. Position Tests. – For a test standard measured several times in different positions by the device all indications shall be within applicable tolerances.

T.5. Influence Factors. – The following factors are applicable to tests conducted under controlled conditions only.

T.5.1. Temperature. – Devices shall satisfy the tolerance requirements under the following temperature conditions.

T.5.1.1. Temperature Limits. – If not marked on the device, the temperature limits shall be – 10 °C to 40 °C (14 °F to 104 °F).

T.5.1.2. Minimum Temperature Range. – If temperature limits are specified for the device, the range shall be at least 30 °C or 54 °F.

T.5.1.3. Temperature Effect on Zero Indication. – The zero indication shall not vary by more than one division per 5 °C (9 °F) change in temperature.

T.5.2. Power Supply Voltage.

T.5.2.1. Alternating Current Power Supply. – Devices that operate using alternating current must perform within the conditions defined in paragraphs T.3. through T.6., inclusive, from – 15 % to + 10 % of the marked nominal line voltage(s) at 60 Hz, or the voltage range marked by the manufacturer, at 60 Hz.

(Added 2004)

T.5.2.2. Direct Current Power Supply. – Devices that operate using direct current shall operate and perform within the applicable tolerance at any voltage level at which the device is capable of displaying metrological registrations.

(Added 2004)

(Amended 2004)

T.6. Disturbances, Field Evaluation. – The following requirements apply to devices when subjected to disturbances which may normally exist in the surrounding environment. These disturbances include radio frequency interference (RFI), electromagnetic interference (EMI), acoustic changes, ambient light emissions, etc. The difference between the measurement indication with the disturbance and the measurement indication without the disturbance shall not exceed one division “d” or the equipment shall:

(a) blank the indication;

(b) provide an error message; or

(c) the indication shall be so completely unstable that it could not be interpreted, or transmitted into memory or to a recording element, as a correct measurement value.

UR. User Requirements

~~UR.1.~~UR.1. Selection Requirements. – Equipment shall be suitable for the service in which it is used with respect to elements of its design, including but not limited to, its maximum capacity, value of the division, minimum capacity, and computing capability.

UR.1.1. Value of the Indicated and Recorded Division. – The value of the division recorded shall be the same as the division value indicated.

UR.2. Installation Requirements. – The NIR analyzer shall be

UR.2.1. Supports. – A device that is portable and is being used on a counter, table, or the floor shall be so positioned that it is firmly and securely supported.

UR.2.2. Foundation, Supports, and Clearance. – The foundations and support of a device installed in an environment within the range of temperature and/or other a fixed location shall be such as to provide

strength, rigidity, and permanence of all components, and clearance shall be provided around all live parts to the extent that no contacts may result when the measuring element is empty, nor throughout the performance range of the device such that the operation or performance of the device is adversely affected.

UR.2.3. Protection from Environmental Factors. – The indicating and measuring elements of a device shall be adequately protected from environmental factors specified in the operating manuals such as wind, weather, and RFI that may adversely affect the operation or performance of the device.

UR.2.—User3. Use Requirements.

UR.2.1. Operating Instructions.—The operating instructions for the NIR analyzer shall be readily available to the user, service technician, and weights and measures official at the place of installation. It shall include a list of accessory equipment if any are required to obtain constituent values, and the type or class of grain to be measured with the NIR analyzer. If an NIR analyzer has the capability, the user is permitted to select the moisture basis to be used on any measurement.

UR.3.1. Minimum and Maximum Measuring Ranges. – A device shall not be used to measure objects smaller than the minimum or larger than the maximum dimensions marked on the device.

UR.3.2. Special Designs. – A multiple dimension measuring device designed and marked for a special application shall not be used for other than its intended purpose.

UR.3.3. Object Placement. – If the object being measured must be transported (e.g., shipped) on a stable side, that irregularly-shaped object must be measured while placed on that stable side. The electronic rotation of the object to determine the smallest hexahedron shall be calculated in a two-dimensional horizontal plane, retaining the stable side plane as the bottom of the hexahedron.

(Added 2008)

(Amended 20042008)

2. Other Devices Not Used for Commercial Measurement. – If there are other NIR analyzers on the premises not used for trade**UR.4. Maintenance Requirements.**

UR.4.1. Zero or determining other charges for services, these devices Ready Condition. – The zero-setting adjustment of a multiple dimension measuring device shall be clearly and conspicuously marked “Not for Use in Trade or Commerce.”

UR.2.3. Printed Tickets.

Printed tickets shall be free from any previous indication of constituent or grain type selected. The printed ticket maintained so that, with no object in or on the measuring element, the device shall indicate constituent values and the moisture basis associated with each constituent value (except moisture). If the analyzer is calibrated to display results on an “as is” moisture basis and does NOT display or or record a moisture value, the ticket must clearly indicate that results are expressed on an “as is” moisture basis **zero or ready condition.**

(Amended 2001)

- (c) ~~The customer shall be given a printed ticket showing the date, grain type or class, constituent results, and calibration version identification. If the analyzer converts constituent results to a manually entered moisture basis, the “native” concentration and the “native” moisture basis must appear on the printed ticket in addition to the converted results and the manually entered moisture basis. If the manually entered moisture basis is intended to be the moisture value for an “as is” constituent concentration measurement, that moisture value must have been obtained on the same sample and must have been measured on a moisture meter certified for commercial use. The information presented on the ticket shall be arranged in a consistent and unambiguous manner. The ticket shall be generated by the near-infrared grain analyzer system.~~

[Nonretroactive as of January 1, 2003]

(Amended 2001)

UR.2.4. Grinders. – Place grinders in a separate room from the NIR analyzer to avoid instrument contamination. If a separate room is not available, the grinder may be in the same room with the NIR analyzer provided the grinder is not placed within one meter of the air intake on the NIR.

UR.2.5. Sampling. – Samples shall be obtained by following appropriate sampling methods and equipment. These include, but are not limited to grain probes of appropriate length used at random locations in the bulk, the use of a pelican sampler, or other techniques and equipment giving equivalent results. The sample shall be taken such that it is representative of the lot. If an NIR analyzer permits user entry of the moisture value for an “as is” constituent measurement, that moisture value must have been obtained on the same sample and must have been measured on a moisture meter certified for commercial use.

(Amended 2001)

UR.4.2.6. Level Condition. ~~–If If a multiple dimension measuring device is equipped with a level-condition indicator, an analyzer shall be maintained in a level condition.~~

~~**UR.2.7. Operating Limitation.**—Constituent determinations shall not be made when the difference in temperatures between the grain sample and the instrument environment (ambient temperature) exceeds manufacturer recommendations.~~

~~**UR.2.8. Slope and Bias Adjustments.**—Bias changes shall be made only on the basis of tests run on a current set of Standard Reference Samples (SRS) traceable to GIPSA Master Instruments.⁴⁴—A written explanation and record of all calibration changes, including those changes made by a manufacturer or the manufacturer’s designated service agency, the device shall be maintained in a level condition. The log shall indicate the date and magnitude of changes in bias and slope constants and the instrument serial number. A Calibration Adjustment Data Sheet for each log entry shall be available for inspection upon request by the field inspector. Data Sheets shall be retained by the user for a period of no less than 18 months following any calibration adjustment. The Data Sheet must show: date of test and adjustment, serial number of the instrument, calibration identification, the nature of the adjustment, the unique identification number and source of sample sets used, and, for each sample in the set, reference values, initial instrument results (except in the cases of instrument failure and repair), and instrument results after calibration adjustment or instrument repair.~~

~~(Amended 1995)~~

UR.4.3. Device Modification. – The measuring capabilities of a device shall not be changed from the manufacturer’s design unless the modification has been approved by the manufacturer and the weights and measures authority having jurisdiction over the device.

UR.5. Customer Information Provided. – The user of a multiple dimension measuring device or system shall provide transaction information to the customer as specified in Table UR.5. Customer Information Provided.

(Added 2004)

⁴⁴ Established error must be known.

| Table UR.5. Customer Information Provided | | | |
|---|---------------------------------|-----------------------------|------------------------------|
| Information | No Contractual Agreement | | Contractual Agreement |
| | Customer Present | Customer not Present | |
| 1. Object identification | N/A | P | P or A |
| 2. Billing method (scale or dimensional weight if used) | D or P | P | P or A |
| 3. Billing rate or rate chart | D or P or A | P or G or A | P or A |
| 4. Dimensional weight (if used) | P | P | P or A |
| 5. Conversion factor (if dimensional weight is used) | D or P or A | P | P or G |
| 6. Dimensional weight statement ¹ (if dimensional weight is used) | D or P | P | P or G |
| 7. Total price | P | P | P or A |
| <p>A = Available upon Request by Customer² D = Displayed G = Published Guidelines or Contracts M = Marked N/A = Not Applicable P = Printed</p> <p>Notes: ¹ This is an explanation that the dimensional weight is not a true weight but is a calculated value obtained by applying a conversion factor to the hexahedron dimensions or volume of the object. ² The information “available upon request by customer” shall be retained by the party having issued the invoice for at least 30 calendar days after the date of invoicing.</p> | | | |

(Added 2004)

Section 5.59. Electronic Livestock, Meat, and Poultry Evaluation Systems and/or Devices

The status of Section 5.59. Electronic Livestock, Meat, and Poultry Evaluation Systems and/or Devices was changed from “tentative” to “permanent” effective January 1, 2013.

(Added 2005) (Amended 2012)

A. Application

A.1. General. – This code applies to electronic devices or systems for measuring the composition or quality constituents of live animals, livestock and poultry carcasses, and individual cuts of meat or a combination thereof for the purpose of determining value.

A.2. Additional Code Requirements. – In addition to the requirements of this code, Electronic Livestock, Meat, and Poultry Evaluation Systems shall meet the requirements of Section 1.10. General Code.

A.3. Exceptions. – This code does not apply to scales used to weigh live animals, livestock and poultry carcasses, and individual cuts of meat unless the scales are part of an integrated system designed to measure composition or quality constituents. Scales used in integrated systems must also meet NIST Handbook 44, Section 2.20. Scale requirements.

S. Specifications

S.1. Design and Manufacture. – All design and manufacturing specifications shall comply with American Society for Testing Materials (ASTM) International Standard F2342 Standard Specification for Design and Construction of Composition or Quality Constituent Measuring Devices or Systems.

N. Notes

N.1. Method of Test. – Performance tests shall be conducted in accordance with ASTM Standard F2343 Test Method for Livestock, Meat, and Poultry Evaluation Devices.

N.2. Testing Standards. – ASTM Standard F2343 requires device or system users to maintain accurate reference standards that meet the tolerance expressed in NIST Handbook 44 Fundamental Considerations, paragraph 3.2. Tolerances for Standards (i.e., one-third of the smallest tolerance applied).

N.3. Verification. – Device or system users are required to verify and document the accuracy of a device or system on each production day as specified by ASTM Standard F2341 Standard Practice of User Requirements for Livestock, Meat, and Poultry Evaluation Devices or Systems.

N.3.1. Official Tests. – Officials are encouraged to periodically witness the required “in house” verification of accuracy. Officials may also conduct official tests using the on-site testing standards or other appropriate standards belonging to the jurisdiction with statutory authority over the device or system.

T. Tolerances

T.1. Tolerances on Individual Measurements. – Maintenance and acceptance tolerances on an individual measurement shall be as shown in Table T.1. Tolerances.

| Table T.1. Tolerances | |
|---|---|
| Individual linear measurement of a single constituent | ± 1 mm (0.039 in) |
| Measurement of area | ± 1.6 cm ² (0.25 in ²) |
| For measurements of other constituents | As specified in ASTM Standard F2343 |

UR. User Requirements

UR.1. Installation Requirements.

UR.1.1. Installation. – All devices and systems shall be installed in accordance with manufacturer's instructions.

UR.2. Maintenance of Equipment.

UR.2.1. Maintenance. – All devices and systems shall be continually maintained in an accurate condition and in accordance with the manufacturer's instructions and ASTM Standard F2341.

UR.3. Use Requirements.

UR.3.1. Limitation of Use. – All devices and systems shall be used to make measurements in a manner specified by the manufacturer.

UR.4. Testing Standards. – The user of a commercial device shall make available to the official with statutory authority over the device testing standards that meet the tolerance expressed in Fundamental Considerations, paragraph 3.2. Tolerances for Standards (i.e., one-third of the smallest tolerance applied). The accuracy of the testing standards shall be verified annually or on a frequency as required by the official with statutory authority and shall be traceable to the appropriate SI standard.



MARKUP COPY

Agency No. 209.02

UNIFORM LAWS AND REGULATIONS

In the area of legal metrology and engine fuel quality



United States Department of Commerce

NIST
130

Technology Administration

National Institute of Standards and Technology

As adopted by the 96th National Conference

On Weights and Measures ~~2013~~2014

NIST Handbook

Foreword

This handbook compiles the latest Uniform Laws and Regulations and related interpretations and guidelines adopted by the National Conference on Weights and Measures, Inc. (NCWM). At the 1983 Annual Meeting, the NCWM voted to change the title of Handbook 130 and the title of the Laws and Regulations compiled in this handbook. The former title of the handbook was “Model State Laws and Regulations.” “Model State” was to be changed to “Uniform” in the title to reflect that these Laws and Regulations are (a) intended to be standards rather than just guidelines, and (b) intended for adoption by political subdivisions other than states when deemed appropriate.

This edition includes amendments approved at the 97th NCWM Annual Meetings in 2012. The NCWM recommends adoption and promulgation by weights and measures jurisdictions of these Uniform Laws and Regulations as updated in this handbook.

The National Institute of Standards and Technology (NIST) has a statutory responsibility to promote “cooperation with the states in securing uniformity of weights and measures laws and methods of inspection.” In partial fulfillment of this responsibility, the Institute is pleased to publish these recommendations of the NCWM.

This handbook promotes the primary use of the International System of Units (SI) by citing SI units before customary units where both units appear together, and by placing separate sections containing requirements for SI units before corresponding sections containing requirements for customary units. In some cases, however, trade practice is currently restricted to the use of customary units; therefore, some requirements in this handbook will continue to specify only customary units until the NCWM achieves a broad consensus on the permitted metric units.

You are invited to provide online feedback regarding this document at: <https://www.surveymonkey.com/s/customer-satisfaction-pub> or by e-mail to: owm@nist.gov.

Committee Members

Committee on Laws and Regulations of the 97th Conference

Judy Cardin, Wisconsin
Raymond Johnson, New Mexico
Richard Lewis, Georgia
Tim Lloyd, Montana
Louis Sakin, Towns of Hopkinton/Northbridge, Massachusetts

Associate Membership Committee Representative: Rob Underwood, Petroleum Marketers Association of America
Fuel and Lubricant Subcommittee: Ron Hayes, Missouri
Packaging and Labeling Subcommittee: Christopher Guay, Procter and Gamble
Canadian Technical Advisor: Lance Robertson, Measurement Canada
NIST Technical Advisors: Lisa Warfield, David Sefcik
NIST Technical Advisor on the Uniform Regulation for National Type Evaluation: Tina Butcher

Past Chairmen of the Committee

| Conference | Chairman | Conference | Chairman |
|------------|---------------------------|------------|--------------------|
| 41 | G. H. Leithauser, MD | 69 | W. R. Mossberg, CA |
| 42 | F. M. Greene, CT | 70 | E. Skluzacek, MN |
| 43 | F. M. Greene, CT | 71 | D. Stagg, AL |
| 44 | G. L. Johnson, KY | 72 | A. Nelson, CT |
| 45 | R. Williams, NY | 73 | K. Simila, OR |
| 46 | J. H. Lewis, WA | 74 | K. Simila, OR |
| 47 | J. H. Lewis, WA | 75 | S. B. Colbrook, IL |
| 48 | J. H. Lewis, WA | 76 | A. Nelson, CT |
| 49 | J. H. Lewis, WA | 77 | B. Bloch, CA |
| 50 | L. Barker, WV | 78 | F. Clem, OH |
| 51 | L. Barker, WV | 79 | B. Bloch, CA |
| 52 | M. Jennings, TN | 80 | S. Rhoades, AZ |
| 53 | W. A. Kerlin, CA | 81 | L. Straub, MD |
| 54 | J. F. Lyles, VA | 82 | S. Millay, ME |
| 55 | J. F. Lyles, VA | 83 | K. Angell, WV |
| 56 | S. D. Andrews, FL | 84 | K. Angell, WV |
| 57 | S. D. Andrews, FL | 85 | S. Morrison, CA |
| 58 | S. D. Andrews, FL | 86 | R. Williams, TN |
| 59 | R. M. Leach, MI | 87 | P. D'Errico, NJ |
| 60 | R. L. Thompson, MD | 88 | D. Johannes, CA |
| 61 | C. H. Vincent, Dallas, TX | 89 | D. Johannes, CA |
| 62 | C. H. Vincent, Dallas, TX | 90 | J. Gomez, NM |
| 63 | J. T. Bennett, CT | 91 | J. Benavides, TX |
| 64 | R. W. Probst, WI | 92 | J. Cassidy, MA |
| 65 | D. I. Offner, MO | 93 | Vicky Dempsey, OH |
| 66 | J. J. Bartfai, NY | 94 | Joe Gomez, NM |
| 67 | J. J. Bartfai, NY | 95 | Joe Benavides, TX |
| 68 | J. J. Bartfai, NY | 96 | John Gaccione, NY |
| | | 97 | Judy Cardin, WI |

20122013 Amendments

The following table lists the laws and regulations amended by the 98th (2013) National Conference on Weights and Measures (NCWM). As appropriate, the text on the cited pages indicates the changes to the law or regulation, section, or paragraph as “Added 2013” or “Amended 2013.” Unless otherwise noted, the effective date of the regulations added or amended in 2013 is January 1, 2014.

| Law or Regulation | L&R Committee Item No. | Section | Action | Page |
|---|---|--|---|-------------------------------|
| Introduction | BOD Item 120-4 | L. Classification for Agenda Items | Amended | 4 |
| | | M. Developing Items | Deleted and renumbered remaining items | 5 to 7 |
| A.—Uniform Weights and Labeling Regulation Measures Law | 231-3 221-1 | Section 1. Definitions | Amended | 22 |
| | | 1.14. Calibration | Amended | 22 |
| | | 1.15. Metrological Traceability | Amended | 22 |
| | | 1.16. Measurement Uncertainty | Amended | 22 |
| | | 1.19. Standard, Reference Measurement | Amended | 23 |
| | | 1.20. Standard, Reference Measurement | Amended | 23 |
| | | 1.21. Standard, Working Measurement | Added | 23 |
| 1.22. Metrological Traceability to a Measurement Unit | Added | 23 | | |
| Uniform Regulation for the Method of Sale of Commodities | 232-3 | 2.33. <u>Oil</u> | Amended | 123-124 133 |
| | | 232-2 | 2.19.1. Retail Sale from Bulk- | 126 |
| | | 2.23. Animal Bedding 2.33.1.5. Tank Trucks or Rail Cars | Amended | 128 134 |
| | 232-7 | 2.32.1. Definition of Hydrogen Fuel- | | 131 |
| | | 2.33. <u>Oil</u> 1.6. Documentation | Added | 131-132 134 |
| | | Reference to enforceable date effective July 1, 2013 | Deleted | |
| | 232-5 | 2.33.1. Labeling 34. Retail Sales of Electricity Sold as a Vehicle Engine (Motor) Oil-Fuel | Added | 134 to 136 |
| | Uniform Engine Fuels and Automotive Lubricants Regulation | 237- 5 | 3.13. Oil | Amended |
| 2.1.3. Gasoline Ethanol Blends. (renumbered to 2.1.2.) 3.13.1.5. Tank Trucks or Rail Cars | | | Amended | 174-175 187 |
| 3.3.4. Nozzle Requirements for Diesel Fuel 3.13.1.6. Documentation | | Added | 180 187 | |
| | | Reference to enforcement date effective July 1, 2013 | Deleted | |

| Law or Regulation | L&R Committee Item No. | Section | Action | Page |
|--|------------------------|--|----------------------|---------|
| G. Uniform Engine Fuels and Automotive Lubricants <i>(continued)</i> | 237-4 | 3.13.1. Labeling of Vehicle Engine (Motor) Oil Required. | Amended | 182–183 |
| | | 3.13.1.1. Viscosity. | Amended | |
| | | 3.13.1.2. Intended Use. | Amended | |
| | | 3.13.1.3. Brand. | Added | |
| | | 3.13.1.3.1. Exception for Quantities of One Gallon (3.785 L) or Less. | Deleted | |
| | | 3.13.1.4. Engine Service Category. | Amended & Renumbered | |
| | | 3.13.1.4.1. Interactive or Obsolete Service Categories. | Added | |
| | | 3.13.1.5. Tank Trucks or Rail Cars. | Added | |
| | 237-7 | 4.1. Water in Gasoline Alcohol Blends, Biodiesel Blends, E85 Fuel Ethanol, Aviation Gasoline, and Aviation Turbine Fuel. | Amended | 185 |
| | | 4.2. Water in Gasoline, Diesel, Gasoline Ether, and Other Fuels. | | |

2013 Editorial Changes

| Law or Regulation | Section | Action | Page |
|--|---|---|-------------------------------|
| Introduction | Note 1 | Updated references | <u>7</u> |
| II. Uniformity of Laws and Regulations | C. Summary of State Laws and Regulations in Weights and Measures (as of August 1, 2012 <u>2013</u>) | Updated tables and tallies. | 10 to 13 |
| A. Uniform Packaging Weights and Labeling Regulation Measures Law | Note 16.6.1. Less than 1 Meter, 1 Square Meter, 1 Kilogram, 1 Cubic Meter, or 1 Liter. | (e) Deleted reference to Sec. 10.11. Cubic Measure in Compressed Form. Updated references | 68 <u>23</u> |
| Uniform Weighmaster Law | 6.6.2. One Meter, 1 Square Meter, 1 Kilogram, 1 Liter, 1 Cubic Meter, or More. <u>Note 1</u> | (e) Deleted Updated reference to Sec. 10.11. Cubic Measure in Compressed Form | 68 <u>39</u> |
| Uniform Packaging and Labeling Regulation | 6.7. Inch Pound Units: Weight, Measure. <u>Note 1</u> | (e) and (f) Deleted reference to Sec. 10.11. Cubic Measure in Compressed Form Updated reference | 69 <u>61</u> |
| B. Uniform Regulation for the Method of Sale of Commodities | B. Uniform Regulation for the Method of Sale of Commodities <u>Note 2</u> | References to ASTM Specifications/Standards— Changed the wording when ASTM specifications or standards are mentioned from a “specific” version date to “the latest version of.” Updated reference | 107—134 <u>109</u> |
| | 2.10.3. Quantity. Table 1. Softwood Lumber Sizes | Added additional lumber sizes | 121 |
| | 2.28 <u>33.1.2. Basis weight.</u> 4. Engine Service Category | Changed “American Society for Testing and Materials” to “ASTM.” Replaced “met” with “displayed” | 129 <u>134</u> |
| B. Uniform Weighmaster Law | Note 1 | Updated references | 39 |
| G. Uniform Engine Fuels and Automotive Lubricants <u>Regulation</u> | G. Uniform <u>3.13.1.4. Engine Fuels and Automotive Lubricants. Service Category</u> | General change in this Section: Replaced “most recent” with “latest,” and added the name of the referenced SAE and ASTM documents. Replaced “met” with “displayed” | 187 |

I. Introduction

A. Source

The Uniform Laws and Regulations¹ in this handbook comprise all of those adopted by the National Conference on Weights and Measures, Inc. (NCWM). The NCWM is supported by the National Institute of Standards and Technology (NIST), which provides its Executive Secretary and publishes its documents. NIST also develops technical publications for use by weights and measures agencies; these publications may subsequently be endorsed or adopted by the NCWM.

The NCWM Committee on Laws and Regulations (the Committee), acting at the request of NCWM or upon its own initiative, prepares with the technical assistance of the National Institute of Standards and Technology (NIST), proposed amendments or additions to the material adopted by NCWM (see Paragraph C). Such revisions, amendments, or additions are then presented to NCWM as a whole where they are discussed by weights and measures officials and representatives of interested manufacturers, industries, consumer groups, and others. Eventually the proposals of the Committee, which may have been amended from those originally presented, are voted upon by the weights and measures officials, following the voting procedures in the NCWM Bylaws. A national consensus is required on all items adopted by the NCWM. A Uniform Law or Regulation is adopted when a majority of the states' representatives, and other voting delegates favoring such adoption, vote for approval.

All of the Uniform Laws and Regulations given herein are recommended by NCWM for adoption by states when reviewing or amending their official laws and regulations in the areas covered. A similar recommendation is made with regard to the local jurisdictions within a state in the absence of the promulgation of such laws and regulations at the state level.

B. Purpose

The purpose of these Uniform Laws and Regulations is to achieve, to the maximum extent possible, uniformity in weights and measures laws and regulations among the various states and local jurisdictions in order to facilitate trade between the states, permit fair competition among businesses, and provide uniform and sufficient protection to all consumers in commercial weights and measures practices.

C. Amendments

The Committee on Laws and Regulations of NCWM serves as a mechanism for consideration of amendments or additions to the Uniform Laws and Regulations.

D. Submission of Agenda Items – Preamble

NCWM Bylaws require that its officers and committees observe the principles of due process for the protection of the rights and interests of affected parties. Specifically, it requires that the committees and officers: (a) give reasonable advance notice of contemplated studies, items to be considered for action, and tentative or definite recommendations for conference vote, and (b) provide that all interested parties have an opportunity to be heard.

E. Submission Process

Anyone introducing an item to the Committee must initially use the regional weights and measures associations to consider its merits. Using the regional associations ensures discussion and evaluation of items at the grassroots level by involving the regional members in the development, evaluation, and justification of proposals. The regions

¹ When referring to the Uniform Laws and Regulations in Handbook 130, Laws and Regulations will be capitalized. When referring to general federal or state laws and regulations, no capitalization will be used.

include the Central, Northeastern, Southern, and Western Weights and Measures Associations. For information on the regional associations, visit www.ncwm.net.

To submit a proposal to a regional association, obtain *Form 15: Proposal to Amend Handbooks* at www.ncwm.net or by contacting NCWM via email at info@ncwm.net. Complete the form and submit it electronically in Microsoft Word format to NCWM at info@ncwm.net and copy the Executive Secretary at owm@nist.gov. An example of the Form 15 template is provided at the end of this section. Instructions for completing the form are included with the electronic version of this template. To ensure that your proposal is included on the regional meeting agenda, submit at least two weeks in advance of the fall regional meeting. Regional meeting schedules are available on the NCWM website.

F. Procedures

The NCWM Committee will consider items according to the following procedures:

1. NCWM Committees receive new items from regional associations, National Type Evaluation Technical Committees (Sectors), task groups, and subcommittees and as defined in Sections H and I. All items to be considered by the Committee for action at the upcoming Interim Meeting must be submitted electronically in Microsoft Word format to NCWM by November 1.
2. NCWM will ensure that all committee members and technical advisors receive complete copies of all new items for consideration at the upcoming NCWM Interim Meeting.

G. Criteria for Inclusion on the NCWM Committee's Agenda

1. Any item approved by at least one regional association and received by the November 1 deadline will be automatically placed on the Committee's Interim Meeting agenda.
2. Items that have not been approved by a regional association, but which are received by November 1, will be evaluated by the Committee using the criteria in Section H, Exceptions to Policy, and Section I, Committee Agenda.
3. Any proposal received after the November 1 deadline, but prior to the Interim Meeting, will be evaluated by the Committee according to Section H, Exceptions to Policy and Section I, Committee Agenda. Only those items determined to be a national "priority" will be included on its agenda.
4. Proposals must be in writing and must include:
 - a. a concise statement of the item or problem outlining the purpose and national need for its consideration. An electronic copy of the background material and proposed amendment(s) should be submitted in a Microsoft Word format on a CD ROM, DVD, or by electronic mail sent to info@ncwm.net;
 - b. background material, including test data, analysis of test data, or other appropriately researched and documented material for the Committee to evaluate when deciding its position or future activity on the proposal;
 - c. proposed solutions to problems stated in specific language and in amendment form as changes to Conference documents; and
 - d. if a proposal involves a new area of weights and measures activity; practical, realistic, and specific recommendations for laws or regulations to be adopted and test methods to be utilized to provide for proper enforcement.

When proposals are to modify or add requirements to existing publications, such as Handbook 130, *Uniform Laws and Regulations in the Areas of Legal Metrology and Engine Fuel Quality*, or Handbook 133, *Checking the Net Content of Packaged Goods*, the proposal should:

- 1) identify the pertinent portion, section, and paragraph of the existing publication that would be changed (e.g., Uniform Method of Sale of Commodities Regulation, Section 8.2, paragraph (b));
- 2) provide evidence of consistency with other NCWM publications such as with other uniform laws and regulations;
- 3) provide evidence of consistency with federal laws and regulations (e.g., U.S. Department of Agriculture [USDA] or Federal Trade Commission [FTC] regulations); and
- 4) relay the positions of businesses, industries, or trade associations affected by the proposal including supporting and opposing points of view.

H. Exceptions to Policy for Submission of Items to the NCWM Committee Agenda; Submission of “Priority” Items

The Committee will use the following criteria to evaluate items that have not been approved by a regional association, but have been received by the November 1 deadline. If an item is received after the November 1 deadline, it will be included on the agenda if the Committee determines that it is a national “priority.”

Criteria for Inclusion on the Committee’s Agenda When No Regional Association Has Approved the Item.

1. Items must have significant legal impact on weights and measures laws and/or regulations involving:
 - a. court cases/attorney general opinions; or
 - b. preemption by federal statute or regulation; or
 - c. conflicts with international standards; or
 - d. items which could affect health and safety.
2. The Committee may contact parties that are potentially affected by an item (e.g., trade associations, industry, and consumer groups) for comments. The Committee may consider these comments and any other information in determining if the item should be included on its agenda.
3. When the Committee determines that it should consider an item as a “priority” (using the criteria in 1.), the item will be handled in the following manner:
 - a. A “priority” item received prior to the Interim Meeting may be added to the Interim Meeting agenda by a majority vote of the Committee.
 - b. A “priority” item received after the Interim Meeting may be added to the Committee’s Annual Meeting agenda as:
 - 1) a discussion item by a majority vote of the Committee; or
 - 2) as a voting item by a majority vote of the Committee and the NCWM Board of Directors.

I. Committee Agenda

1. The Committee will review items that have been submitted and selected by a majority vote to be included on its agenda. The Committee will only include those items that have been:
 - a. approved by at least one of the regional associations; or
 - b. forwarded by other committees, subcommittees, NTETC Sectors, task forces, or work groups, or those items that meet the criteria in Section H, Exceptions to Policy.

2. The Committee will publish an agenda (NCWM Publication 15) that identifies the items to be discussed during the Interim Meeting. This agenda will be distributed to members approximately 30 days prior to the meeting. The agenda will be provided upon request to all other interested parties.

(Amended 1998)

J. Interim Meeting

1. The Committee shall hold public hearings at the Interim Meeting for the purpose of discussing and taking comments on all agenda items.
2. Upon request, the Committee will provide the opportunity for presentations by government officials, industry representatives, consumer groups, or other interested parties during the Interim Meeting. Requests to make presentations must be received by the Committee Chairman or Technical Advisor at least two weeks prior to the start of the meetings.

K. Interim Meeting Report

1. Items under consideration by the Committee, and about which the Committee offers comments or recommendations to NCWM to act upon during the Annual Meeting, will be included in the Committee's Interim Report published in the Annual Meeting Program and Committee Reports (NCWM Publication 16).
2. The Annual Meeting Program and Committee Reports will be prepared and distributed to Conference members approximately three months prior to the NCWM Annual Meeting.

L. Classifications for Agenda Items

At the Interim Meeting, the Committee can classify proposals in one of four ways as:

1. ~~“Voting” – these are items proposed for a vote by NCWM membership and are indicated with a “V” after the item number in the agenda; or~~
2. ~~“Informational” – these are items which require further study, comment, and development and are indicated with an “I” after the item number in the agenda; or~~
3. ~~“Withdrawn” – these are items which will no longer be considered by the Committee and are indicated with a “W” after the item number in the agenda.~~

M. Developing Items

~~In the past, the Committee had either carried undeveloped proposals forward as informational, or withdrawn them. Conference members felt that carrying undeveloped informational items on its agenda for years posed an unnecessary drain on NCWM resources. Alternatively, the Conference was also concerned that withdrawing items prematurely resulted in the Committee discarding valuable work that had gone into identifying and presenting the items. NCWM was also interested in providing a mechanism to inform parties about items that were developing in different localities or in the regional associations.~~

~~At the 1998 Annual Meeting, a process was established for disseminating information on items that may have merit but are insufficiently developed for Committee action. NCWM established a new “Developing” designation to allow the Committee to notify the submitter that while this item may have merit, it has not been adequately developed for action at the national level. NCWM agreed that developing items should be submitted by the regional associations with a recommendation that they be presented as “D” items on the national agenda.~~

~~The Committee will present “D” items in list format at the end of its report and include a point of contact (including the name and telephone number of the submitter) so that interested parties can obtain additional information. No comments will be taken on a developing item unless the Committee agrees to receive the new information in advance of the hearing. In these cases, the Chairman will announce in advance that an item will be discussed in the~~

session. The use of this “D” designator is seen as an item management tool, as well as a way to keep the membership informed of emerging items.

1. **“Voting” – These are items the Committee believes are fully developed and ready for final consideration of the voting membership. Each item has either received majority support from the Committee or the Committee has reached agreement that it is ready for voting status to let NCWM membership decide. The Committee has the ability to remove items from the voting agenda at the Annual Meeting by changing the status prior to a vote of the NCWM membership. The Committee may amend voting items during the course of the Annual Meeting based on additional information received following the Interim Meeting and testimony received at the Annual Meeting. These items may also be amended by the voting membership during the voting session of the Annual Meeting following the procedures outlined in the NCWM Bylaws; or**
2. **“Informational” – These items are deemed by the Committee to have merit. They typically contain a proposal to address the issue at hand and a meaningful background discussion for the proposal. However, the Committee wants to allow more time for review by stakeholders and possibly further development to address concerns. The Committee has taken the responsibility for any additional development of Informational items. For particularly difficult items, the Committee may assign the item to an existing Subcommittee under its charge or request that the NCWM Chair appoint a special task group that reports to the Committee. At the Annual Meeting, the Committee may change the status of the items, but not to Voting status because the item has not been published as such in advance of the meeting; or**
3. **“Developing” – These items are deemed by the Committee to have merit, but are found to be lacking enough information for full consideration. Typically the item will have a good explanation of the issue, but a clear proposal has yet to be developed. By assigning Developing status, the Committee has sent the item back to the source or assigned it to some other entity outside the scope of the Committee with the responsibility of further development. The Committee Report will provide the source with clear indication of what is necessary to move the item forward for full consideration. The item will be carried in the Committee agenda in bulletin board fashion with contact information for the person or organization that is responsible for the development. Since the Committee is not required to receive testimony on developing items, this status should be carefully implemented so as not to weaken the standards development process; or**
4. **“Withdrawn” – These are items that the Committee has found to be without merit. The Committee's determination to withdraw should not be based on the Committee's opinion alone, but on the input received from stakeholders. The Committee's report will contain an explanation for the withdrawal of the item. Once an item appears in NCWM Publication 16 as Withdrawn, the status of that item may not be amended. The item may be reintroduced through the regional associations for consideration as a new item.**

(Amended 2013)

M. Comments on Interim Reports

1. Weights and measures officials, industry representatives, and all others are encouraged to submit written comments on items in the Committee’s Interim Report.
2. All comments on the Interim Meeting Report must be submitted to the Committee with a copy to the Executive Secretary no later than one month preceding the opening of the Annual Meeting.

ØN. Annual Meeting

1. The Committee will hold a public hearing at the Annual Meeting to discuss items on its agenda.
2. Those who want to speak on an item during the public hearing should request time from the Committee Chairman. The Committee Chairman may impose time limits on presentations, the discussion of a question, or the discussion of a proposed amendment.

PQ. Final Committee Reports and Conference Action

1. Following the public hearings, the Committee will prepare its final report for action by the voting membership of the Conference. Copies of the final report will be provided to the membership prior to the voting session for that report.
2. The Chairman of the Committee will present the final report of the Committee to the Conference body. A vote will be taken on items, proposals, or sections in the report as circumstances require. The Conference will vote on the entire final report as presented in accordance with established Conference voting procedures. Parliamentary procedures according to Robert's Rules of Order, as amended by NCWM Bylaws, must be adhered to in the presentation of, and any action on, a Standing Committee report.
(Amended 1998)

QP. Revisions to the Handbook

NIST may not publish a new edition if it determines that it is reasonable to forego an annual publication (e.g., amendments were minor or editorial in nature) to save printing, mailing, and other costs. If this occurs, NIST will issue a notice that the current edition is still valid and will explain its action. (**Note:** Section numbering may be changed from one edition of the handbook to another to accommodate additions or deletions.)
(Amended 2008)

RQ. Annotation

Beginning in 1971, amendments or additions to sections in the Uniform Laws and Regulations are delineated at the end of each section (e.g., “amended 1982”) as a service to those states that are planning to update their own laws or regulations. The references to each revision and the year will enable legislators and rule makers to study the actual wording and rationale for changes (appearing in the Annual Report of NCWM for that year) and subsequently adopt changes in their own laws and regulations, modeling them after the Uniform Laws and Regulations.

SR. Effective Enforcement Dates of Regulations

Unless otherwise specified, the new or amended regulations listed in this section are intended to become effective and subject to enforcement on January 1 of the year following adoption by NCWM.

1. Uniform Packaging and Labeling Regulation
2. Uniform Regulation for the Method of Sale of Commodities
3. Uniform Unit Pricing Regulation
4. Uniform Regulation for the Voluntary Registration of Servicepersons and Service Agencies for Commercial Weighing and Measuring Devices
5. Uniform Open Dating Regulation
6. Uniform Regulation for National Type Evaluation
7. Uniform Regulation for Engine Fuels, Petroleum Products, and Automotive Lubricants

(Added 1992)

TS.Section References

In most references made to specific sections or subsections in this handbook, the word “Section” is used, followed by the section number.

UT. The International System of Units

The “International System of Units,” “SI,” or “SI Units” means the modernized metric system as established in 1960 by the General Conference on Weights and Measures (GIPM). In 1988, Congress amended the Metric Conversion Act of 1975 (see Section 5164 of Public Law 100-418) to declare that it is the policy of the United States to designate the metric system of measurement as the preferred measurement system for U.S. trade and commerce, and it further defined “the metric system of measurement” to be the International System as established by the GIPM and as interpreted or modified for the United States by the Secretary of Commerce. [See Metric Conversion Law 15 U.S.C. 205, NIST Special Publication 330 – The International System of Units (SI); NIST Special Publication 814 – Metric System of Measurement; and, Interpretation of the International System of Units for the United States in Federal Register of May 16, 2008, (“Federal Register” Vol. 73, No. 96) or subsequent revisions]. In 1992, Congress amended the Federal Fair Packaging and Labeling Act to require certain consumer commodities to include the appropriate SI units along with the customary inch-pound units in their quantity statements.

(Added 1993) (Revised 2008)

VU. “Mass” and “Weight.” [NOTE 1, page 7]

The mass of an object is a measure of the object’s inertial property, or the amount of matter it contains. The weight of an object is a measure of the force exerted on the object by gravity, or the force needed to support it. The pull of gravity on the earth gives an object a downward acceleration of about 9.8 m/s^2 . In trade and commerce and everyday use, the term “weight” is often used as a synonym for “mass.” The “net mass” or “net weight” declared on a label indicates that the package contains a specific amount of commodity exclusive of wrapping materials. The use of the term “mass” is predominant throughout the world, and is becoming increasingly common in the United States.

(Added 1993)

WV. Use of the Terms “Mass” and “Weight.” [NOTE 1, page 7]

When used in this handbook, the term “weight” means “mass.” The term “weight” appears when inch-pound units are cited, or when both inch-pound and SI units are included in a requirement. The terms “mass” or “masses” are used when only SI units are cited in a requirement. The following note appears where the term “weight” is first used in a law or regulation.

***NOTE 1:** When used in this law (or regulation), the term “weight” means “mass.” (See paragraphs ~~V-U~~, “**Mass**” and ~~W~~. **Weight** and **V. Use of the Terms “Mass” and “Weight”** in Section I, Introduction of NIST Handbook 130 for an explanation of these terms.)*

(Added 1993)

Form 15: Proposal to Amend Handbooks



| General Information (See Instructions) | | | |
|---|--|--|----------------------------|
| 1. Date: | 2. Regional Association(s): ___ Central (CWMA) ___ Northeastern (NEWMA) ___ Southern (SWMA) ___ Western (WWMA) | 3. Standing Committee: ___ L&R ___ S&T ___ PDC | |
| 4. Submitter Name: | | | |
| 5. Street Address: | | | |
| 6. City: | | 7. State: | 8. Zip Code: |
| 10. Phone Number: | | 11. Fax Number: | 12. E-mail Address: |
| 9. Country: | | | |
| Proposal Information (See Instructions) | | | |
| 13. Purpose: | | | |
| 14. Handbook to be Amended: ___ NIST Handbook 44 ___ NIST Handbook 130 ___ NIST Handbook 133 Section: Paragraph: | | | |
| 15. Proposal: | | | |
| 16. Justification: | | | |
| 17. Other Contacts: | | | |
| 18. Other Reasons For: | | | |
| 19. Other Reasons Against: | | | |
| 20. Evidence: | | | |
| 21. Additional Considerations: | | | |
| 22. Suggested Action: ___ Recommend NCWM Adoption ___ Developing Item ___ Informational Item ___ Other (Please Describe): | | | |
| 23. List of Attachments: | | | |
| For Regional Use Only | | | |
| Comments: | | | |

Submit Form Via Email to don.onwiler@ncwm.net:
 1135 M Street, Suite 110 / Lincoln, Nebraska 68508
 P. 402.434.4880 F. 402.434.4878 E. info@ncwm.net W. www.ncwm.net

Revised: February 2011

II. Uniformity of Laws and Regulations

A. National Conference Goal

The goal of the National Conference on Weights and Measures (NCWM) with respect to these Uniform Laws and Regulations is to achieve their acceptance in all states and local jurisdictions that have authority over such matters. The Conference stands ready to assist any jurisdiction in any way possible in securing adoption.

B. Status of Promulgation

The following pages list, by state, information regarding the adoption of the Uniform Laws and Regulations. The tabulated data indicates if the state has adopted the Uniform Law or Regulation by reference, including subsequent amendments (thereby operating under the most recent version of the recommended regulation in this handbook), or if the state has used some version of the NCWM recommended law or regulation as guidance in developing a similar law or regulation.

The information is verified with each state annually; the entries represent the status of the state adoption at the time of the survey.

Unless a state adopts the recommended regulations and subsequent amendments and revisions, there may be variation in the actual degree of adoption. Adoption, implementation, and clarification may be determined by comparing a state law with the Uniform Law, section-by-section, or by contacting the state.

(Amended 1997 and 1998)

C. Summary of State Laws and Regulations in Weights and Measures (as of August 1, 2013)

This is an overview of the status of adoption of NCWM standards by the states. In earlier editions of Handbook 130, state laws and regulations were compared to the NCWM standard from the prior year. This did not indicate whether the standard as printed in the current edition had been adopted by any given state. The table lists those states that adopt NCWM-recommended updates automatically (“YES”); see Sections 4 through 10 and paragraph 12(m) of the Uniform Weights and Measures Law. This means the state’s regulations are current with those printed in this edition of the handbook. If a state has adopted an NCWM recommendation in whole or in part from a particular year, but updates are not incorporated automatically, a lower case “yes” is shown. For additional information on the status of adoption, please contact the appropriate state officials.

| State | Laws | | | Regulations | | | | | | | | | |
|----------------------|--------------------------|-------------------------------|-------------------------|------------------------|----------------|------------------------------------|--------------|----------------------------------|-------------|-----------------|--------------------------------|------------------------------------|------------------------------------|
| | Weights and Measures Law | Weighmaster Law or Regulation | Uniform Engine Fuel Law | Packaging and Labeling | Method of Sale | Price Verification | Unit Pricing | Registration of Service Agencies | Open Dating | Type Evaluation | Uniform Engine Fuel Regulation | Handbook 44 | Handbook 133 |
| Alabama | yes | yes | yes | yes | yes | YES | NO | yes | NO | yes | yes* | YES | YES |
| Alaska | yes | NO | NO | YES | YES | yes * Y | NO | yes | NO | yes | NO | YES | yes |
| Arizona | yes | yes | yes* | yes | yes | yes | NO | yes | no | yes | yes* | YES | YES |
| Arkansas | YES | NO | YES | YES | YES | YES | YES | YES | YES | YES | YES | YES | YES |
| California | yes | yes* | yes* | YES | yes* | Y yes* | yes* | yes* | NO | yes | yes* | YES | YES |
| Colorado | yes | yes | yes* | yes | yes | X YES | NO | yes | NO | YES | yes* | YES | YES |
| Connecticut | yes | yes | yes* | YES | YES | YES | yes* | yes* | YES | yes | yes | YES | YES |
| Delaware | yes | yes | yes* | yes | yes | yes | no | yes* | no | yes | yes* | YES | YES |
| District of Columbia | yes | yes | NO | yes | yes | no | NO | NO | yes* | no | NO | yes | no |
| Florida | yes | NO | yes* | yes | yes | YES yes s | yes* | yes | yes* | no | yes* | YES yes s | YES yes s |
| Georgia | yes | yes | yes* | yes | yes | X YES | NO | yes | yes* | yes | yes* | YES | YES |
| Hawaii | yes | yes | yes* | yes | yes | X YES | yes | yes | NO | yes | yes* | yes | yes |
| Idaho | yes | yes | yes* | yes | yes | X YES | no | yes | NO | yes | yes* | YES | YES yes s |
| Illinois | yes | NO | yes* | YES | YES | NO | NO | yes | NO | yes | yes | YES | YES |
| Indiana | yes | yes* | yes* | yes | yes | NO | NO | NO | NO | yes | yes* | yes | yes |
| Iowa | yes | yes* | yes* | yes | yes | X YES | NO | yes* | NO | yes | yes* | yes | yes |
| Kansas | yes | NO | yes | yes | yes | X YES | NO | yes | NO | yes | yes | yes | yes |

Key: YES Adopted and updated on an annual basis.
 yes Law or regulation in force, NCWM standard used as basis of adoption, but from an earlier year.
 yes* Law or regulations in force, but not based on NCWM standard.
 NO No law or regulation.
 no No law or regulation, but NCWM standard is used as a guideline.

| State | Laws | | | Regulations | | | | | | | | | |
|----------------|--------------------------|-------------------------------|-------------------------|------------------------|----------------|--------------------|------------------|----------------------------------|-------------|-----------------|--------------------------------|-------------|--------------|
| | Weights and Measures Law | Weighmaster Law or Regulation | Uniform Engine Fuel Law | Packaging and Labeling | Method of Sale | Price Verification | Unit Pricing | Registration of Service Agencies | Open Dating | Type Evaluation | Uniform Engine Fuel Regulation | Handbook 44 | Handbook 133 |
| Kentucky | yes | NO | yes* | yes | yes | YES | NO | yes Yes | NO | yes | yes* | YES | yes |
| Louisiana | yes* | yes* | yes* | yes* | NO | YES | no | yes* | NO | yes* | yes* | YES | no |
| Maine | yes | yes | yes* | YES | YES | YES | NO | yes | NO | yes | YES | YES | no |
| Maryland | yes | NO | yes* | YES | yes | YES | yes* | yes* | yes* | yes | yes* | YES | YES |
| Massachusetts | yes* | yes* | yes* | yes | yes* | YES | yes* | NO | NO | yes | yes* | YES | no |
| Michigan | yes | yes | yes | yes | yes | NO | NO | yes | yes | yes | yes* | yes | yes |
| Minnesota | yes | NO | yes* | yes* | yes* | NO | NO | yes* | yes* | yes | yes* | yes | yes |
| Mississippi | yes | yes | yes* | yes | yes | X YES | yes | yes | NO | yes | yes* | YES | YES |
| Missouri | yes | NO | yes | YES | YES | YES | NO no | yes | NO | YES | yes | YES | YES |
| Montana | yes | NO | yes | yes | yes | NO | yes | yes | NO | yes | yes | yes | yes |
| Nebraska | yes | NO | NO | yes | yes | Y yes* | NO | yes | NO | yes* | NO | yes | yes |
| Nevada | yes | yes | yes* | YES | YES | X YES | YES | YES | YES | YES | yes* | YES | YES |
| New Hampshire | yes | yes* | NO | YES | YES | YES | YES | yes* | yes* | no | no | YES | YES |
| New Jersey | yes | yes | yes* | yes | yes | yes* | yes* | yes* | NO | yes* | NO | YES | NO |
| New Mexico | yes | yes | yes* | yes | yes | X YES | NO | yes | yes* | NO | yes* | YES | YES |
| New York | yes | yes | yes* | yes | yes | YES | yes* | NO | NO | yes | yes* | YES | YES |
| North Carolina | yes | yes* | yes* | YES | YES | X YES | NO | yes | NO | yes | yes* | YES | YES |

Key: YES Adopted and updated on an annual basis.
 yes Law or regulation in force, NCWM standard used as basis of adoption, but from an earlier year.
 yes* Law or regulations in force, but not based on NCWM standard.
 NO No law or regulation.
 no No law or regulation, but NCWM standard is used as a guideline.

| State | Laws | | | Regulations | | | | | | | | | |
|----------------|--------------------------|-------------------------------|-------------------------|------------------------|----------------|------------------------------|-----------------------------|----------------------------------|-------------|-----------------|--------------------------------|-------------|----------------------------|
| | Weights and Measures Law | Weighmaster Law or Regulation | Uniform Engine Fuel Law | Packaging and Labeling | Method of Sale | Price Verification | Unit Pricing | Registration of Service Agencies | Open Dating | Type Evaluation | Uniform Engine Fuel Regulation | Handbook 44 | Handbook 133 |
| North Dakota | YES | NO | NO | NO | yes* | NO | NO | yes* | NO | NO | yes* | yes* | NO |
| Ohio | yes | NO | NO | yes | yes | YES | NO | yes | NO | yes | NO | YES | YES |
| Oklahoma | YES | NO | yes* | YES | YES | yes* | NO | yes* | YES | YES | yes* | YES | YES |
| Oregon | yes | NO | yes* | yes | yes | yes | yes* | NO | yes* | yes | yes | yes | yes |
| Pennsylvania | yes | yes | NO | yes | yes | yes | NO | yes | NO | YES | NO | YES | YES |
| Puerto Rico | yes | yes | yes* | yes | yes* | yes* | yes* | yes | yes* | yes | yes* | YES | YES |
| Rhode Island | no | no | yes* | yes* | YES | no | yes* | NO | yes* | no | no | YES | NO <u>NO</u> |
| South Carolina | yes | yes* | yes* | YES | YES | YES <u>yes</u> | NO | YES | NO | YES | yes* | YES | YES |
| South Dakota | yes | NO | yes | yes | yes | YES <u>yes</u> | NO | yes | yes | yes | yes | yes | yes |
| Tennessee | yes | yes | yes | YES | YES | YES | NO | yes | NO | YES | yes | YES | YES |
| Texas | yes | yes* | yes* | YES | YES | yes* | NO | yes | NO | NO | yes* | YES | YES |
| Utah | yes | NO | yes* | YES | YES | YES | NO | yes | NO | YES | yes | YES | YES |
| Vermont | yes* | yes | yes* | YES | YES | YES | yes* | yes | NO | no | NO | YES | NO <u>NO</u> |
| Virginia | yes* | yes* | YES | YES | YES | YES | YES | yes* | NO | yes* | YES | YES | YES |
| Virgin Islands | yes | NO | yes* | yes | NO | NO | yes | NO | yes | NO | yes | YES | NO <u>NO</u> |
| Washington | yes | yes | yes | YES | YES | YES | yes <u>NO</u> | yes | yes | yes | yes | YES | YES |
| West Virginia | YES | NO | YES | YES | YES | YES | YES | YES | YES | YES | YES | YES | YES |

Key: YES Adopted and updated on an annual basis.
 yes Law or regulation in force, NCWM standard used as basis of adoption, but from an earlier year.
 yes* Law or regulations in force, but not based on NCWM standard.
 NO No law or regulation.
 no No law or regulation, but NCWM standard is used as a guideline.

| State | Laws | | | Regulations | | | | | | | | | |
|-------------|--------------------------|-------------------------------|-------------------------|------------------------|----------------|--------------------|--------------|----------------------------------|-------------|-----------------|--------------------------------|-------------|--------------|
| | Weights and Measures Law | Weighmaster Law or Regulation | Uniform Engine Fuel Law | Packaging and Labeling | Method of Sale | Price Verification | Unit Pricing | Registration of Service Agencies | Open Dating | Type Evaluation | Uniform Engine Fuel Regulation | Handbook 44 | Handbook 133 |
| Wisconsin | yes* | NO | yes* | yes | YES | YES | NO | yes* | NO | YES | yes* | YES | YES |
| Wyoming | yes | NO | yes* | yes* | no | YES | no | yes | no | YES | yes* | YES | YES |
| Totals: YES | 4 | 0 | 2 | 29 | 27 | 30 | 5 | 4 | 10 | 12 | 4 | 41 | 34 |
| yes | 43 | 21 | 3 | 20 | 20 | 7 | 5 | 28 | 31 | 28 | 7 | 41 | 43 |
| yes* | 5 | 10 | 8 | 28 | 25 | 7 | 11 | 14 | 3 | 4 | 2 | 40 | 30 |
| NO | 0 | 21 | 35 | 4 | 5 | 7 | 27 | 7 | 9 | 4 | 9 | 12 | 14 |
| no | 1 | 1 | 7 | 1 | 2 | 2 | 28 | 0 | 32 | 5 | 32 | 1 | 0 |
| | | | 0 | 0 | 1 | | 5 | | 3 | | 8 | 0 | 2 |
| | | | | | | | | | 0 | | 2 | 0 | 7 |
| | | | | | | | | | 0 | | 0 | | |
| | | | | | | | | | 0 | | 0 | | |

Key: YES Adopted and updated on an annual basis.
 yes Law or regulation in force, NCWM standard used as basis of adoption, but from an earlier year.
 yes* Law or regulations in force, but not based on NCWM standard.
 NO No law or regulation.
 no No law or regulation, but NCWM standard is used as a guideline.
~~X~~ Price verification program in place. Inspection based on NCWM Price Verification Procedure.
~~Y~~ Price verification program in place. Inspection not based on NCWM Price Verification Procedure.

THIS PAGE INTENTIONALLY LEFT BLANK

MARKUP COPY

A. Uniform Weights and Measures Law

as adopted by
The National Conference on Weights and Measures*

1. Background

Recognition of the need for uniformity in weights and measures laws and regulations among the states was first noted at the second Annual Meeting of the National Conference on Weights and Measures (NCWM) in April 1906. In the following year, basic outlines of a “Model State Weights and Measures Law” were developed. The first “Model Law,” as such, was formally adopted by the Conference in 1911.

Through the years, almost without exception, each state has relied upon the NCWM Weights and Measures Law when the state first enacted comprehensive weights and measures legislation. This has led to a greater degree of uniformity in the basic weights and measures requirements throughout the country.

The original Law was regularly amended to provide for new developments in commercial practices and technology. This resulted in a lengthy and cumbersome document and in the need for a simplification of the basic weights and measures provisions. The 1971 NCWM adopted a thoroughly revised, simplified, modernized version of the “Model State Weights and Measures Law.” This Law now can serve as a framework for all the many concerns in weights and measures administration and enforcement.

The title of the Law was changed by the 1983 NCWM. Amendments or revisions to the Law since 1971 are noted at the end of each section.

Sections 4 through 10 of the Uniform Weights and Measures Law adopt NIST Handbook 44 and the Uniform Regulations in NIST Handbook 130 by citation. In addition, these sections adopt supplements to and revisions of Handbook 44 and the Uniform Regulations “except insofar as modified or rejected by regulation.” Some state laws may not permit enacting a statute that provides for automatic adoption of future supplements to or revisions of a Uniform Regulation covered by that statute. If this should be the case in a given state, two alternatives are available:

- (a) Sections 4 through 10 may be enacted without the phrase “. . . and supplements thereto or revisions thereof . . .”; or
- (b) Sections 4 through 10 may be enacted by replacing “. . . except insofar as modified or rejected by regulation . . .” with the phrase “. . . as adopted, or amended and adopted, by rule of the director.”

Either alternative requires action on the part of the Director to adopt a current version of Handbook 44 and each Uniform Regulation each time a supplement or revision is made by the NCWM.

2. Status of Promulgation

See the table beginning on page 10, Section II. Uniformity of Laws and Regulations of Handbook 130 for the status of adoption of the Uniform Weights and Measures Law.

**The National Conference on Weights and Measures (NCWM) is supported by National Institute of Standards and Technology (NIST) in partial implementation of its statutory responsibility for “cooperation with the states in securing uniformity in weights and measures laws and methods of inspection.”*

THIS PAGE INTENTIONALLY LEFT BLANK

MARKUP COPY

Uniform Weights and Measures Law

Section 1. Definitions

When used in this Act:

1.1. Weight(s) and (or) Measure(s). – The term “weight(s) and (or) measure(s)” means all weights and measures of every kind, instruments and devices for weighing and measuring, and any appliance and accessories associated with any or all such instruments and devices.

1.2. Weight. – The term “weight” as used in connection with any commodity or service means net weight. When a commodity is sold by drained weight, the term means net drained weight.

(Amended 1974 and 1990)

1.3. Correct. – The term “correct” as used in connection with weights and measures means conformance to all applicable requirements of this Act.

1.4. Director. – The term “director” means the Director of the Arkansas State Plant Board.

1.5. Person. – The term “person” means both plural and the singular, as the case demands, and includes individuals, partnerships, corporations, companies, societies, and associations.

1.6. Sale from Bulk. – The term “sale from bulk” means the sale of commodities when the quantity is determined at the time of sale.

1.7. Package. – Except as modified by Section 1. Application of the Uniform Packaging and Labeling Regulation, the term “package,” whether standard package or random package, means any commodity:

- (a) enclosed in a container or wrapped in any manner in advance of wholesale or retail sale; or
- (b) whose weight or measure has been determined in advance of wholesale or retail sale.

An individual item or lot of any commodity on which there is marked a selling price based on an established price per unit of weight or of measure shall be considered a package (or packages).

(Amended 1991)

1.8. Net “Mass” or Net “Weight.” – The term “net mass” or “net weight” means the weight ^[NOTE 1, page 21] of a commodity excluding any materials, substances, or items not considered to be part of the commodity. Materials, substances, or items not considered to be part of the commodity include, but are not limited to, containers, conveyances, bags, wrappers, packaging materials, labels, individual piece coverings, decorative accompaniments, and coupons, except that, depending on the type of service rendered, packaging materials may be considered to be part of the service. For example, the service of shipping includes the weight of packing materials.

(Added 1988) (Amended 1989, 1991, and 1993)

1.9. Random Weight Package. – A package that is one of a lot, shipment, or delivery of packages of the same commodity with no fixed pattern of weights.

(Added 1990)

NOTE 1: *When used in this Law, the term “weight” means “mass.” (See paragraphs V-U. “Mass” and W-“Weight” and V. Use of the Terms “Mass” and “Weight” in Section I. Introduction of NIST Handbook 130 for an explanation of these terms.)*

(Note added 1993)

1.10. Standard Package. – A package that is one of a lot, shipment, or delivery of packages of the same commodity with identical net contents declarations.

Examples:

1 L bottles or 12 fl oz cans of carbonated soda;

500 g or 5 lb bags of sugar;

100 m or 300 ft packages of rope.

(Added 1991) (Amended 1993)

1.11. Commercial Weighing and Measuring Equipment. – The term “commercial weighing and measuring equipment” means weights and measures and weighing and measuring devices commercially used or employed in establishing the size, quantity, extent, area, or measurement of quantities, things, produce, or articles for distribution or consumption, purchased, offered, or submitted for sale, hire, or award, or in computing any basic charge or payment for services rendered on the basis of weight or measure.

(Added 1995)

1.12. Standard, Field. – A physical standard that meets specifications and tolerances in NIST Handbook 105-series standards (or other suitable and designated standards) and is traceable to the reference or working standards through comparisons, using acceptable laboratory procedures, and used in conjunction with commercial weighing and measuring equipment (1.13. Accreditation).

(Added 2005)

1.13. Accreditation. – A formal recognition by a recognized Accreditation Body that a laboratory is competent to carry out specific tests or calibrations or types of tests or calibrations. **NOTE:** Accreditation does not ensure compliance of standards to appropriate specifications.

(Added 2005)

1.14. Calibration. – ~~A set of operations which establishes~~An operation that, under specified conditions, the ~~relationship in a first step, establishes a relation~~ between the quantity values indicated with measurement uncertainties provided by a measuring instrument or measuring system, or values represented by a material measure, measurement standards and the corresponding known values of indications with associated measurement uncertainties and, in a measurand second step, uses this information to establish a relation for obtaining a measurement result from an indication.

(Added 2005) (Amended 2013)

1.15. Metrological Traceability. – The property of ~~the result of a measurement~~ result or the value of a standard whereby ~~it the result~~ the result can be related to ~~stated references, usually national or international standards, a reference~~ through ~~an~~ a documented unbroken chain of comparisons all having stated ~~uncertainties~~ calibrations, each contributing to the measurement uncertainty.

(Added 2005) (Amended 2013)

1.16. Measurement Uncertainty. – A non-negative parameter associated with the result of a measurement that characterizes characterizing the dispersion of the quantity values that could reasonably be being attributed to the ~~measurand~~ measurand, based on the information used.

(Added 2005) (Amended 2013)

1.17. Verification. – The formal evaluation of a standard or device against the specifications and tolerances for determining conformance.

(Added 2005)

1.18. Recognition. – A formal recognition by NIST Office of Weights and Measures that a laboratory has demonstrated the ability to provide traceable measurement results and is competent to carry out specific tests or calibrations or types of tests or calibrations.

(Added 2005)

1.19. Standard, Reference Measurement. – A measurement standard, generally designated for the calibration of the highest metrological quality available other measurement standards for quantities of a given kind in a given organization or at a given location, from which measurements made at that location are derived. The term “reference measurement standards” usually means the physical standards of the state that serve as the legal reference from which all other standards for weights and measures within that state are derived.

(Added 2005) (Amended 2013)

1.20. Standard, Working Measurement. – A measurement standard that is usually calibrated against a reference standard, and is used routinely to calibrate or check material measures, verify measuring instruments or reference materials, measuring systems. The term “working measurement standards” means the physical standards that are traceable to the reference standards through comparisons, calibrations or verifications, using acceptable laboratory procedures, and used in the enforcement of weights and measures laws and regulations.

(Added 2005) (Amended 2013)

1.21. Metrological Traceability Chain. – Sequence of measurement standards and calibrations that is used to relate a measurement result to a reference.

(Added 2013)

1.22. Metrological Traceability to a Measurement Unit. – Metrological traceability where the reference is the definition of a measurement unit through its practical realization.

(Added 2013)

Section 2. Systems of Weights and Measures

The International System of Units (SI) and the system of weights and measures in customary use in the United States are jointly recognized, and either one or both of these systems shall be used for all commercial purposes in the state.

The definitions of basic units of weight and measure, the tables of weight and measure, and weights and measures equivalents as published by NIST are recognized and shall govern weighing and measuring equipment and transactions in the state.

(Amended 1993)

***NOTE 2: SI or SI Unit.** – means the International System of Units as established in 1960 by the General Conference on Weights and Measures and interpreted or modified for the United States by the Secretary of Commerce. See “Interpretation of the International System of Units for the United States” in “Federal Register” (Volume 73, No. 96, pages 28432 to 28433) for May 16, 2008, and 15 United States Code, Section 205a - 205l “Metric Conversion.” See also NIST Special Publication 330, “The International System of Units (SI),” 2008 edition and NIST Special Publication 811, “Guide for the Use of the International System of Units (SI),” 2008 edition that are available at www.nist.gov/pml/wmd/metric/metric-program.cfm or by contacting TheSI@nist.gov.*

(Added 1993)

Section 3. Physical Standards

Weights and measures that are traceable to the U.S. prototype standards supplied by the Federal Government, or approved as being satisfactory by NIST, shall be the state reference and working standards of weights and measures, and shall be maintained in such calibration as prescribed by the NIST as demonstrated through laboratory accreditation or recognition. All field standards may be prescribed by the Director and shall be verified upon their initial receipt and as often thereafter as deemed necessary by the Director.

(Amended 2005)

Section 4. Technical Requirements for Weighing and Measuring Devices ^[NOTE 3, page 24]

The specifications, tolerances, and other technical requirements for commercial, law enforcement, data gathering, and other weighing and measuring devices as adopted by the NCWM, published in the National Institute of Standards and Technology Handbook 44, “Specifications, Tolerances, and Other Technical Requirements for Weighing and Measuring Devices,” and supplements thereto or revisions thereof, shall apply to weighing and measuring devices in the state, except insofar as modified or rejected by regulation.

(Amended 1975)

***NOTE 3:** Sections 4 through 10 of the Uniform Weights and Measures Law adopt NIST Handbook 44 and Uniform Regulations in NIST Handbook 130 by citation. In addition, these sections adopt supplements to and revisions of NIST Handbook 44 and the Uniform Regulations “except insofar as modified or rejected by regulation.” Some state laws may not permit enacting a statute that provides for automatic adoption of future supplements to or revisions of a regulation covered by that statute. If this should be the case in a given state, two alternatives are available:*

- (a) Sections 4 through 10 may be enacted without the phrase “. . . and supplements thereto or revisions thereof . . .”; or
- (b) Sections 4 through 10 may be enacted by replacing “. . . except insofar as modified or rejected by regulation . . .” with the phrase “. . . as adopted, or amended and adopted, by rule of the director.”

Either alternative requires action on the part of the Director to adopt a current version of Handbook 44 and Uniform Laws or Regulations each time a supplement is added or revision is made by the NCWM.

Section 5. Requirements for Packaging and Labeling ^[NOTE 3, page 24]

The Uniform Packaging and Labeling Regulation as adopted by the NCWM and published in the National Institute of Standards and Technology Handbook 130, “Uniform Laws and Regulations,” and supplements thereto or revisions thereof, shall apply to packaging and labeling in the state, except insofar as modified or rejected by regulation.

(Added 1983)

Section 6. Requirements for the Method of Sale of Commodities ^[NOTE 3, page 24]

The Uniform Regulation for the Method of Sale of Commodities as adopted by the NCWM and published in National Institute of Standards and Technology Handbook 130, “Uniform Laws and Regulations,” and supplements thereto or revisions thereof, shall apply to the method of sale of commodities in the state, except insofar as modified or rejected by regulation.

(Added 1983)

Section 7. Requirements for Unit Pricing ^[NOTE 3, page 24]

The Uniform Unit Pricing Regulation as adopted by the NCWM and published in the National Institute of Standards and Technology Handbook 130, “Uniform Laws and Regulations,” and supplements thereto or revisions thereof, shall apply to unit pricing in the state, except insofar as modified or rejected by regulation.

(Added 1983)

Section 8. Requirements for the Registration of Servicepersons and Service Agencies for Commercial Weighing and Measuring Devices ^[NOTE 3, page 24]

The Uniform Regulation for the Voluntary Registration of Servicepersons and Service Agencies for Commercial Weighing and Measuring Devices as adopted by the National NCWM and published in the National Institute of Standards and Technology Handbook 130, “Uniform Laws and Regulations,” and supplements thereto or revisions

thereof, shall apply to the registration of servicepersons and service agencies in the state, except insofar as modified or rejected by regulation.

(Added 1983)

Section 9. Requirements for Open Dating [NOTE 3, page 24]

The Uniform Open Dating Regulation as adopted by the NCWM and published in the National Institute of Standards and Technology Handbook 130, “Uniform Laws and Regulations,” and supplements thereto or revisions thereof, shall apply to open dating in the state, except insofar as modified or rejected by regulation.

(Added 1983)

Section 10. Requirements for Type Evaluation [NOTE 3, page 24]

The Uniform Regulation for National Type Evaluation as adopted by the NCWM and published in National Institute of Standards and Technology Handbook 130, “Uniform Laws and Regulations,” and supplements thereto or revisions thereof, shall apply to type evaluation in the state, except insofar as modified or rejected by regulation.

(Added 1985)

Section 11. State Weights and Measures Division

There shall be a State Division of Weights and Measures located for administrative purposes within the Arkansas State Plant Board. The Division is charged with, but not limited to, performing the following functions on behalf of the citizens of the state:

- (a) Assuring that weights and measures in commercial services within the state are suitable for their intended use, properly installed, and accurate, and are so maintained by their owner or user.
- (b) Preventing unfair or deceptive dealing by weight or measure in any commodity or service advertised, packaged, sold, or purchased within the state.
- (c) Making available to all users of physical standards or weighing and measuring equipment the precision calibration and related metrological certification capabilities of the weights and measures facilities of the Division.
- (d) Promoting uniformity, to the extent practicable and desirable, between weights and measures requirements of this state and those of other states and federal agencies.
- (e) Encouraging desirable economic growth while protecting the consumer through the adoption by rule of weights and measures requirements as necessary to assure equity among buyers and sellers.

(Added 1976)

Section 12. Powers and Duties of the Director

The Director shall:

- (a) maintain traceability of the state standards as demonstrated through laboratory accreditation or recognition;
(Amended 2005)
- (b) enforce the provisions of this Act;
- (c) issue reasonable regulations for the enforcement of this Act, which regulations shall have the force and effect of law;

- (d) establish labeling requirements, establish requirements for the presentation of cost per unit information, establish standards of weight, measure, or count, and reasonable standards of fill for any packaged commodity; and establish requirements for open dating information;
(Added 1973)
- (e) grant any exemptions from the provisions of this Act or any regulations promulgated pursuant thereto when appropriate to the maintenance of good commercial practices within the state;
- (f) conduct investigations to ensure compliance with this Act;
- (g) delegate to appropriate personnel any of these responsibilities for the proper administration of this office;
- (h) verify the field standards for weights and measures used by any jurisdiction within the state, before being put into service, tested annually or as often thereafter as deemed necessary by the Director based on statistically evaluated data, and approve the same when found to be correct;
(Amended 2005)
- (i) have the authority to inspect and test commercial weights and measures kept, offered, or exposed for sale;
(Amended 1995)
- (j) inspect and test, to ascertain if they are correct, weights and measures commercially used:
 - (1) in determining the weight, measure, or count of commodities or things sold, or offered or exposed for sale, on the basis of weight, measure, or count; or
 - (2) in computing the basic charge or payment for services rendered on the basis of weight, measure, or count.
- (k) test all weights and measures used in checking the receipt or disbursement of supplies in every institution, the maintenance of which funds are appropriated by the legislature of the state;
- (l) approve for use, and may mark, such commercial weights and measures as are found to be correct, and shall reject and order to be corrected, replaced, or removed such commercial weights and measures as are found to be incorrect. Weights and measures that have been rejected may be seized if not corrected within the time specified or if used or disposed of in a manner not specifically authorized. The Director shall remove from service and may seize the weights and measures found to be incorrect that are not capable of being made correct;
(Amended 1995)
- (m) weigh, measure, or inspect packaged commodities kept, offered, or exposed for sale, sold, or in the process of delivery, to determine whether they contain the amounts represented and whether they are kept, offered, or exposed for sale in accordance with this Act or regulations promulgated pursuant thereto. In carrying out the provisions of this section, the Director shall employ recognized sampling procedures, such as are adopted by the NCWM and are published in the National Institute of Standards and Technology Handbook 133, "Checking the Net Contents of Packaged Goods;"
(Amended 1984, 1988, and 2000)
- (n) prescribe, by regulation, the appropriate term or unit of weight or measure to be used, whenever the Director determines that an existing practice of declaring the quantity of a commodity or setting charges for a service by weight, measure, numerical count, time, or combination thereof, does not facilitate value comparisons by consumers, or offers an opportunity for consumer confusion;
(Amended 1991)

- (o) allow reasonable variations from the stated quantity of contents, which shall include those caused by loss or gain of moisture during the course of good distribution practice or by unavoidable deviations in good manufacturing practice only after the commodity has entered intrastate commerce;
 - (p) provide for the training of weights and measures personnel, and may establish minimum training and performance requirements, which shall then be met by all weights and measures personnel, whether county, municipal, or state. The Director may adopt the training standards of the National Conference on Weights and Measures' National Training Program and the laboratory metrology standards specified by the NIST accreditation and/or recognition requirements; and
(Added 1991) (Amended 2005)
 - (q) verify advertised prices, price representations, and point-of-sale systems, as deemed necessary, to determine:
 - (1) the accuracy of prices and computations and the correct use of the equipment; and
 - (2) if such system utilizes scanning or coding means in lieu of manual entry, the accuracy of prices printed or recalled from a database. In carrying out the provisions of this section, the Director shall:
 - i. employ recognized procedures, such as are designated in National Institute of Standards and Technology Handbook 130, *Uniform Laws and Regulations in the Areas of Legal Metrology and Engine Fuel Quality*, "Examination Procedures for Price Verification;"
 - ii. issue necessary rules and regulations regarding the accuracy of advertised prices and automated systems for retail price charging (referred to as "point-of-sale systems") for the enforcement of this section, which rules shall have the force and effect of law; and
 - iii. conduct investigations to ensure compliance.
- (Added 1995)

Section 13. Special Police Powers

When necessary for the enforcement of this Act or regulations promulgated pursuant thereto, the Director is:

- (a) Authorized to enter any commercial premises during normal business hours, except that in the event such premises are not open to the public, he/she shall first present his/her credentials and obtain consent before making entry thereto, unless a search warrant has previously been obtained.
- (b) Empowered to issue stop use, hold, and removal orders with respect to any weights and measures commercially used, stop sale, hold, and removal orders with respect to any packaged commodities or bulk commodities kept, offered, or exposed for sale.
- (c) Empowered to seize, for use as evidence, without formal warrant, any incorrect or unapproved weight, measure, package, or commodity found to be used, retained, offered, or exposed for sale or sold in violation of the provisions of this Act or regulations promulgated pursuant thereto.
- (d) Empowered to stop any commercial vehicle and, after presentation of his credentials, inspect the contents, require the person in charge of that vehicle to produce any documents in his possession concerning the contents, and require him to proceed with the vehicle to some specified place for inspection.
- (e) With respect to the enforcement of this Act, the Director is hereby vested with special police powers, and is authorized to arrest, without formal warrant, any violator of this Act.

Section 14. Powers and Duties of Local Officials

Any weights and measures official appointed for a county or city shall have the duties and powers enumerated in this Act, excepting those duties reserved to the state by law or regulation. These powers and duties shall extend to their respective jurisdictions, except that the jurisdiction of a county official shall not extend to any city for which a weights and measures official has been appointed. No requirement set forth by local agencies may be less stringent than or conflict with the requirements of the state.

(Amended 1984)

Section 15. Misrepresentation of Quantity

No person shall:

- (a) sell, offer, or expose for sale a quantity less than the quantity represented; nor
- (b) take more than the represented quantity when, as buyer, he/she furnishes the weight or measure by means of which the quantity is determined; nor
- (c) represent the quantity in any manner calculated or tending to mislead or in any way deceive another person.

(Amended 1975 and 1990)

Section 16. Misrepresentation of Pricing

No person shall misrepresent the price of any commodity or service sold, offered, exposed, or advertised for sale by weight, measure, or count, nor represent the price in any manner calculated or tending to mislead or in any way deceive a person.

Section 17. Method of Sale

Except as otherwise provided by the Director or by firmly established trade custom and practice,

- (a) commodities in liquid form shall be sold by liquid measure or by weight; and
- (b) commodities not in liquid form shall be sold by weight, by measure, or by count.

The method of sale shall provide accurate and adequate quantity information that permits the buyer to make price and quantity comparisons.

(Amended 1989)

Section 18. Sale from Bulk

All bulk sales in which the buyer and seller are not both present to witness the measurement, all bulk deliveries of heating fuel, and all other bulk sales specified by rule or regulation of the director shall be accompanied by a delivery ticket containing the following information:

- (a) the name and address of the buyer and seller;
- (b) the date delivered;
- (c) the quantity delivered and the quantity upon which the price is based, if this differs from the delivered quantity for example, when temperature compensated sales are made;

(Amended 1991)

- (d) the unit price, unless otherwise agreed upon by both buyer and seller;
(Added 1991)
- (e) the identity in the most descriptive terms commercially practicable, including any quality representation made in connection with the sale; and
- (f) the count of individually wrapped packages, if more than one, in the instance of commodities bought from bulk but delivered in packages.
(Amended 1983 and 1991)

Section 19. Information Required on Packages

Except as otherwise provided in this Act or by regulations promulgated pursuant thereto, any package, whether a random package or a standard package, kept for the purpose of sale, or offered or exposed for sale, shall bear on the outside of the package a definite, plain, and conspicuous declaration of:

- (a) the identity of the commodity in the package, unless the commodity is a food, other than meat or poultry, that was repackaged in a retail establishment and the food is displayed to the purchaser under either of the following circumstances:
 - (1) its interstate labeling is clearly in view or with a counter card, sign or other appropriate device bearing prominently and conspicuously the common or usual name of the food; or
 - (2) the common or usual name of the food is clearly revealed by its appearance.
(Amended 2001)
- (b) the quantity of contents in terms of weight, measure, or count; and,
- (c) the name and place of business of the manufacturer, packer, or distributor, in the case of any package kept, offered, or exposed for sale, or sold in any place other than on the premises where packed.
(Amended 1991)

Section 20. Declarations of Unit Price on Random Weight Packages

In addition to the declarations required by Section 19. Information Required on Packages of this Act, any package being one of a lot containing random weights of the same commodity, at the time it is offered or exposed for sale at retail, shall bear on the outside of the package a plain and conspicuous declaration of the price per kilogram or pound and the total selling price of the package.

(Amended 1986)

Section 21. Advertising Packages for Sale

Whenever a packaged commodity is advertised in any manner with the retail price stated, there shall be closely and conspicuously associated with the retail price a declaration of quantity as is required by law or regulation to appear on the package.

(Amended 1993)

Section 22. Prohibited Acts

No person shall:

- (a) use or have in possession for use in commerce any incorrect weight or measure;
- (b) sell or offer for sale for use in commerce any incorrect weight or measure;
- (c) remove any tag, seal, or mark from any weight or measure without specific written authorization from the proper authority;
- (d) hinder or obstruct any weights and measures official in the performance of his or her duties; or
- (e) violate any provisions of this Act or regulations promulgated under it.

Section 23. Civil Penalties

23.1. Assessment of Penalties. – Any person who by himself or herself, by his or her servant or agent, or as the servant or agent of another person, commits any of the acts enumerated in Section 22. Prohibited Acts may be assessed by the Arkansas State Plant Board a civil penalty of:

- (a) not less than \$100 nor more than \$600 for a first violation;
- (b) not less than \$400 nor more than \$1200 for a second violation within 3 years after the date of the first violation; **and**
- (c) not less than \$700 nor more than \$2000 for a third violation within 3 years after the date of the first violation.

23.2. Administrative Hearing. – Any person subject to a civil penalty shall have a right to request an administrative hearing within ten days of receipt of the notice of the penalty. The Director or his/her designee shall be authorized to conduct the hearing after giving appropriate notice to the respondent. The decision of the Director shall be subject to appropriate judicial review.

23.3. Collection of Penalties. – If the respondent has exhausted his or her administrative appeals and the civil penalty has been upheld, he or she shall pay the civil penalty within twenty days after the effective date of the final decision. If the respondent fails to pay the penalty, a civil action may be brought by the Director in any court of competent jurisdiction to recover the penalty. Any civil penalty collected under this Act shall be transmitted to Arkansas State Plant Board.

(Added 1989) (Amended 1995)

Section 24. Criminal Penalties

24.1. Misdemeanors. – Any person who commits any of the acts enumerated in Section 22. Prohibited Acts shall be guilty of a Class A misdemeanor.

Section 25. Restraining Order and Injunction

The Director is authorized to apply to any court of competent jurisdiction for a restraining order, or a temporary or permanent injunction, restraining any person from violating any provision of this Act.

(Retitled 1989)

Section 26. Presumptive Evidence

Whenever there shall exist a weight or measure or weighing or measuring device in or about any place in which or from which buying or selling is commonly carried on, there shall be a rebuttable presumption that such weight or measure or weighing or measuring device is regularly used for the business purposes of that place.

Section 27. Separability Provision

If any provision of this Act is declared unconstitutional, or the applicability thereof to any person or circumstance is held invalid, the constitutionality of the remainder of the Act and the applicability thereof to other persons and circumstances shall not be affected thereby.

Section 28. Repeal of Conflicting Laws

All laws and parts of laws contrary to or inconsistent with the provisions of this Act are repealed except as to offenses committed, liabilities incurred, and claims made there under prior to the effective date of this Act.

Section 29. Regulations to be Unaffected by Repeal of Prior Enabling Statute

The adoption of this Act or any of its provisions shall not affect any regulations promulgated pursuant to the authority of any earlier enabling statute unless inconsistent with this Act or modified or revoked by the Director.

Section 30. Effective Date

This Act shall become effective on August 1, ~~2013~~2014.

THIS PAGE INTENTIONALLY LEFT BLANK

MARKUP COPY

C. Uniform Engine Fuels and Automotive Lubricants Inspection Law

as adopted by
The National Conference on Weights and Measures*

1. Background

In 1984, the National Conference on Weights and Measures (NCWM) adopted a section in the Uniform Regulation for the Method of Sale of Commodities requiring that motor fuel containing alcohol be labeled to disclose to the retail purchaser that the fuel contains alcohol. The delegates deemed this action necessary since motor vehicle manufacturers were qualifying their warranties with respect to some gasoline-alcohol blends, motor fuel users were complaining to weights and measures officials about fuel quality and vehicle performance, and the American Society for Testing and Materials (ASTM) had not yet finalized quality standards for oxygenated (which includes alcohol-containing) fuels. While many argued that weights and measures officials should not cross the line from quantity assurance programs to programs regulating quality, the delegates were persuaded that the issue needed immediate attention.

A Motor Fuels Task Force was appointed in 1984 to develop mechanisms for achieving uniformity in the evaluation and regulation of motor fuels. The Task Force developed the Uniform Motor Fuel Inspection Law and the Uniform Motor Fuel Regulation (see the Uniform Regulations section of this Handbook) to accompany the Law. The recommended Law required registration and certification of motor fuel as meeting ASTM standards. It established a motor fuel quality testing capability by the state. Funding for the installation and support of the testing facility was established by a fee per liter or per gallon on all fuel marketed within the state.

In 1992, the NCWM established the Petroleum Subcommittee under the Laws and Regulations Committee. The Subcommittee recommended major revisions to the Law that was adopted at the 80th NCWM in 1995. The scope of the Law was expanded to include all engine fuels, petroleum products, and automotive lubricants, and its title was changed accordingly. Other changes included expansion of the definitions section, limitation of the scope of the registration section to engine fuels designed for special use, and addition of sections on administrative and civil penalties and on criminal penalties.

In 2007, the Fuel and Lubricants Subcommittee (formerly the Petroleum Subcommittee) undertook a review of this uniform law to update it to eliminate reference to “petroleum products” and reflect the addition of new engine fuels to the marketplace. The amendments included new provisions to provide officials with the authority to review delivery records and grant waivers of requirements adopted under the law in times of emergency or natural disasters.

At the 2008 NCWM Interim Meeting, the Laws and Regulations Committee changed the Petroleum Subcommittee’s name to the Fuels and Lubricants Subcommittee (FALS) in recognition of its work with a wide variety of fuels including petroleum and biofuels.

2. Status of Promulgation

The current Uniform Engine Fuels and Automotive Lubricants Inspection Law was recommended for adoption by the Conference in 2008. The table beginning on page 10, Section II. Uniformity of Laws and Regulations of Handbook 130 shows the status of adoption of the law.

(Amended 2008)

**The National Conference on Weights and Measures (NCWM) is supported by the National Institute of Standards and Technology (NIST) in partial implementation of its statutory responsibility for “cooperation with the states in securing uniformity in weights and measures laws and methods of inspection.”*

THIS PAGE INTENTIONALLY LEFT BLANK

MARKUP COPY

Uniform Engine Fuels and Automotive Lubricants Inspection Law

Section 1. Purpose

There should be uniform requirements for engine fuels, non-engine fuels, and automotive lubricants among the states. This Act provides for the establishment of quality specifications for these products.

(Amended 2008)

Section 2. Scope

The Act establishes a sampling, testing, and enforcement program, provides authority for fee collection, requires registration of engine fuels, and empowers the state to promulgate regulations as needed to carry out the provisions of the Act. It also provides for administrative, civil, and criminal penalties.

Section 3. Definitions

As used in this act:

3.1. Engine Fuel. – Any liquid or gaseous matter used for the generation of power in an internal combustion engine.

3.2. Director. – The Director of the Arkansas State Plant and designated agents.

3.3. Person. – An individual, corporation, company, society, association, partnership, or governmental entity.

3.4. ASTM International. (www.astm.org) – An international voluntary consensus standards organization formed for the development of standards on characteristics and performance of materials, products, systems, and services, and the promotion of related knowledge.

3.5. Automotive Lubricants. – Any material interposed between two surfaces that reduces the friction or wear between them.

3.6. Engine Fuel Designed for Special Use. – Engine fuels designated by the Director requiring registration. These fuels normally have no ASTM or other national consensus standards applying to their quality or usability; common special fuels are racing fuels and those intended for agricultural and other off-road applications.

3.7. Sold. – Kept, offered, or exposed for sale.

3.8. Non-engine Fuels. – Any liquid or gaseous matter used for the generation of heat, power, or similar uses.

(Added 2008)

Section 4. Administration, Adoption of Standards, and Rules

The provisions of this Act shall be administered by the Director. For the purpose of administering and giving effect to the provisions of this Act, the specification and test method standards set forth in the most recent version available of ASTM International standards as published on its website www.astm.org are adopted except as amended or modified as required by the Director to comply with federal and state laws. When no ASTM standard exists, other generally recognized national consensus standards may be used. The Director is empowered to write rules and regulations on the advertising, posting of prices, labeling, standards for, and identity of fuels, non-engine fuels, and automotive lubricants and is authorized to establish a testing laboratory.

(Amended 2008)

Section 5. General Duties and Powers

The Director shall have the authority to:

5.1. Enforce and administer all the provisions of this Act by inspections, analyses, and other appropriate actions.

5.2. Have access during normal business hours to all places where engine fuels, non-engine fuels, and automotive lubricants are kept, transferred, offered, exposed for sale, or sold for the purpose of examination, inspection, taking of samples, and review of fuel storage, receipts, transfers, sales records, or delivery records for determining compliance with this Act. If such access is refused by the owner, agent, or other persons leasing the same, the Director may obtain an administrative search warrant from a court of competent jurisdiction.

(Amended 2008)

5.3. Collect, or cause to be collected, samples of engine fuels, non-engine fuels, and automotive lubricants marketed in this state, and cause such samples to be tested or analyzed for compliance with the provisions of this Act.

(Amended 2008)

5.4. Define engine fuels for special use and refuse, revoke, suspend, or issue a stop-order if found not to be in compliance and remand stop-order if the engine fuel for special use is brought into full compliance with this Act.

5.5. Issue a stop-sale order for any engine fuel, non-engine fuels, and automotive lubricant found not to be in compliance and remand a stop-sale order if the engine fuel, petroleum product, or automotive lubricant is brought into full compliance with this Act.

(Amended 2008)

5.6. Refuse, revoke, or suspend the registration of an engine fuel, petroleum product, or automotive lubricant.

5.7. Delegate to appropriate personnel any of these responsibilities for the proper administration of this Act.

5.8. The Director is empowered to waive specific state requirements adopted under this Act or may establish alternative requirements for fuels as determined to be necessary in the event of an emergency or a natural disaster for a specified period of time.

(Added 2008)

Section 6. Registration of Engine Fuels Designed for Special Use

All engine fuels designed for special use must be registered with the Director. Such registration shall include:

6.1. Name, brand, or trademark under which the fuel will be sold.

6.2. Name and address of person registering the engine fuel.

6.3. The special use for which the engine fuel is designed.

6.4. A certification, declaration, or affidavit stating the fuel specifications.

Section 7. Inspection Fee

There shall be a fee of \$Zero per appropriate unit of measure on all products covered under the scope of this Act marketed within this state for the purposes of administering and effectively enforcing the provisions of this Act.

Section 8. Prohibited Acts

It shall be unlawful to:

8.1. Represent engine fuels, non-engine fuels, or automotive lubricants in any manner that may deceive or tend to deceive the purchaser as to the nature, brand, price, quantity, and/or quality of such products.

(Amended 1996 and 2008)

8.2. Fail to register an engine fuel designed for special use.

8.3. Submit incorrect, misleading, or false information regarding the registration of an engine fuel designed for special use.

8.4. Hinder or obstruct the Director in the performance of the Director's duties.

8.5. Represent an engine fuel, non-engine fuels, or automotive lubricant that is contrary to the provisions of this Act.

(Amended 2008)

8.6. Represent automotive lubricants with an S.A.E. (Society of Automotive Engineers) viscosity grade or API (American Petroleum Institute) service classification other than those specified by the intended purchaser.

(Added 1996)

Section 9. Civil Penalties

9.1. Assessment of Penalties. – Any person who, by himself or herself, by his or her servant or agent, or as the servant or agent of another person commits any of the acts enumerated in Section 8. Prohibited Acts may be assessed by the Arkansas State Plant Board a civil penalty of:

(a) not less than \$100 nor more than \$300 for a first violation;

(b) not less than \$400 nor more than \$600 for a second violation within three years from the date of the first violation; and

(c) not less than \$700 nor more than \$1,000 for a third violation within three years from the date of the first violation.

9.2. Administrative Hearing. – Any person subject to a civil penalty shall have a right to request an administrative hearing within ten days of receipt of the notice of the penalty. The Director or his/her designee shall be authorized to conduct the hearing after giving appropriate notice to the respondent. The decision of the Director shall be subject to appropriate judicial review.

9.3. Collection of Penalties. – If the respondent has exhausted his or her administrative appeals and the civil penalty has been upheld, he or she shall pay the civil penalty within twenty days after the effective date of the final decision. If the respondent fails to pay the penalty, a civil action may be brought by the Director in any court of competent jurisdiction to recover the penalty. Any civil penalty collected under this Act shall be transmitted to Arkansas State Plant Board.

Section 10. Criminal Penalties

10.1. Misdemeanor. – Any person who violates any provision of this Act or regulations promulgated thereto shall be guilty of a Class A.

Section 11. Restraining Order and Injunction

The Director is authorized to apply to any court of competent jurisdiction for a restraining order or a temporary or permanent injunction restraining any person from violating any provision of this Act.

Section 12. Severability Provisions

If any word, phrase, provision, or portion of this Act shall be held in a court of competent jurisdiction to be unconstitutional or invalid, the unconstitutionality or invalidity shall apply only to such word, phrase, provision, or portion, and for this purpose the provisions of this Act are declared to be severable.

Section 13. Repeal of Conflicting Laws

All laws and parts of laws contrary to or inconsistent with the provisions of this Act are repealed except as to offense committed, liabilities incurred, and claims made there under prior to the effective date of this Act.

Section 14. Citation

This Act may be cited as the “Engine Fuels and Automotive Lubricants Inspection Act of .”
(Amended 2008)

Section 15. Effective Date

This Act shall become effective August 1, ~~2013~~2014.

A. Uniform Packaging and Labeling Regulation

as adopted by
The National Conference on Weights and Measures*

1. Background

The Uniform Packaging and Labeling Regulation was first adopted during the 37th Annual Meeting of the National Conference on Weights and Measures (NCWM) in 1952. Reporting to the Conference, the Committee on Legislation stated:

The National Conference should adopt a model package regulation for the guidance of those states authorized to adopt such a regulation under provisions of their weights and measures laws. Since so much of the work of weights and measures officials in the package field concerns food products, the importance of uniformity between the Federal (FDA) regulations and any model regulations to be adopted by this Conference cannot be overemphasized.

Since its inception, the Uniform Packaging and Labeling Regulation has been continually revised to meet the complexities of an enormous expansion in the packaging industry – an expansion that, in late 1966, brought about the passage of the Fair Packaging and Labeling Act (FPLA). Recognizing the need for compatibility with the Federal Act, in 1968 the Committee on Laws and Regulations of the 53rd Annual Meeting of the National Conference amended the “Model Packaging and Labeling Regulation” (renamed in 1983) to parallel regulations adopted by federal agencies under FPLA. The process of amending and revising this Regulation is a continuing one in order to keep it current with practices in the packaging field and make it compatible with appropriate federal regulations. Amendments and additions since 1971 are noted at the end of each section.

The revision of 1978 provided for the use of the metric system (SI) on labels as well as allowing SI-only labels for those commodities not covered by federal laws or regulations. “SI” means the International System of Units as established in 1960 by the General Conference on Weights and Measures and interpreted or modified for the United States by the Secretary of Commerce. [See the “Interpretation of the International System of Units for the United States” in the “Federal Register” (Volume 73, No. 96, pages 28432 to 28433) for May 16, 2008, and 15 United States Code, Section 205a - 2051 “Metric Conversion.” See also NIST Special Publication 330 “The International System of Units (SI)” 2008 edition and NIST Special Publication 811 “Guide for the Use of the International System of Units (SI)” 2008 edition that are available at www.nist.gov/pml/wmd/index.cfm or by contacting TheSI@nist.gov.] In 1988, Congress amended the Metric Conversion Law to declare that it is the policy of the United States to designate the International System of Units of measurement as the preferred system of weights and measures for U.S. trade and commerce. In 1992, Congress amended the federal FPLA to require the most appropriate units of the SI and the customary inch-pound systems of measurement on certain consumer commodities. The 1993 amendments to NIST Handbook 130 require SI and inch-pound units on certain consumer commodities in accordance with federal laws or regulations. Requirements for labeling in both units of measure were effective February 14, 1994, under FPLA and as specified in Section 15 Effective Date; except as specified in Section 11.32. SI Units, Exemptions for Consumer Commodities.

Nothing contained in this regulation should be construed to supersede any labeling requirement specified in federal law or to require the use of SI units on non-consumer packages.

2. Status of Promulgation

The table beginning on page 10, Section II. Uniformity of Laws and Regulations of Handbook 130 shows the status of adoption of the Uniform Packaging and Labeling Regulation.

**The National Conference on Weights and Measures (NCWM) is supported by the National Institute of Standards and Technology (NIST) in partial implementation of its statutory responsibility for “cooperation with the states in securing uniformity in weights and measures laws and methods of inspection.”*

THIS PAGE INTENTIONALLY LEFT BLANK

MARKUP COPY

Uniform Packaging and Labeling Regulation

Preamble

The purpose of this regulation is to provide accurate and adequate information on packages as to the identity and quantity of contents so that purchasers can make price and quantity comparisons.

(Added 1989)

Section 1. Application

This regulation shall apply to packages, but shall not apply to:

- (a) inner wrappings not intended to be individually sold to the customer;
- (b) shipping containers or wrapping used solely for the transportation of any commodities in bulk or in quantity to manufacturers, packers, or processors, or to wholesale or retail distributors, but in no event shall this exclusion apply to packages of consumer or non-consumer commodities as defined herein;
(Added 1971)
- (c) auxiliary containers or outer wrappings used to deliver packages of such commodities to retail customers if such containers or wrappings bear no printed matter pertaining to any particular commodity;
- (d) containers used for retail tray pack displays when the container itself is not intended to be sold (e.g., the tray that is used to display individual envelopes of seasonings, gravies, etc., and the tray itself is not intended to be sold);
- (e) open carriers and transparent wrappers or carriers for containers when the wrappers or carriers do not bear any written, printed, or graphic matter obscuring the label information required by this regulation; or
- (f) packages intended for export to foreign countries.

(Amended 1994 and 1998)

Section 2. Definitions

2.1. Package. – Except as modified by Section 1. Application, the term “package,” whether standard package or random package, means any commodity:

- (a) enclosed in a container or wrapped in any manner in advance of wholesale or retail sale; or
- (b) whose weight ^[NOTE 1, page 61] or measure has been determined in advance of wholesale or retail sale. An individual item or lot of any commodity on which there is marked a selling price based on an established price per unit of weight or of measure shall be considered a package or packages.

(Amended 1988 and 1991)

NOTE 1: When used in this regulation, the term “weight” means “mass.” (See paragraphs U. “Mass” and “Weight” in Section I. Introduction of NIST Handbook 130 for an explanation of these terms.)

2.2. Consumer Package of Consumer Commodity. – A package that is customarily produced or distributed for sale through retail sales agencies or instrumentalities for consumption or use by individuals for the purposes of personal care or in the performance of services ordinarily rendered in or about the household or in connection with personal possessions.

(Amended 1988 and 1991)

2.3. Non-consumer Package: Package of Non-consumer Commodity. – Any package other than a consumer package, and particularly a package intended solely for industrial or institutional use or for wholesale distribution.
(Amended 1988 and 1991)

2.4. Random Package. – A package that is one of a lot, shipment, or delivery of packages of the same consumer commodity with no fixed pattern of net contents.
(Amended 1988 and 1990)

2.5. Label. – Any written, printed, or graphic matter affixed to, applied to, attached to, blown into, formed, molded into, embossed on, or appearing upon or adjacent to a consumer commodity, or a package containing any consumer commodity, for purposes of branding, identifying, or giving any information with respect to the commodity or to the contents of the package, except that an inspector's tag or other non-promotional matter affixed to or appearing upon a consumer commodity shall not be considered a label requiring the repetition of label information required by this regulation.
(Amended 1988)

2.6. Person. – The term “person” means either singular or plural and shall include any individual, partnership, company, corporation, association, or society.
(Amended 1988)

2.7. Principal Display Panel or Panels. – That part, or those parts, of a label that is, or are, so designed as to most likely be displayed, presented, shown, or examined under normal and customary conditions of display and purchase. Wherever a principal display panel appears more than once on a package, all requirements pertaining to the “principal display panel” shall pertain to all such “principal display panels.”
(Amended 1988)

2.8. Multi-unit Package. – A package containing two or more individual packages of the same commodity, in the same quantity, intended to be sold as a multi-unit package, but where the component packages are labeled individually in full compliance with all requirements of this regulation.
(Amended 1988)

2.9. Combination Package. – A package intended for retail sale, containing two or more individual packages or units of dissimilar commodities.

Examples:

An antiquing or housecleaning kit;
sponge and cleaner;
lighter fluid and flints.

(Added 1989)

2.10. Variety Package. – A package intended for retail sale, containing two or more individual packages or units of similar, but not identical, commodities. Commodities that are generically the same, but that differ in weight, measure, volume, appearance, or quality, are considered similar, but not identical.

Examples:

Two sponges of different sizes;
plastic tableware, consisting of 4 spoons, 4 knives, and 4 forks.

(Added 1989)

2.11. Petroleum Products. – Gasoline, diesel fuel, kerosene, or any product (whether or not such a product is actually derived from naturally occurring hydrocarbon mixtures known as “petroleum”) commonly used in powering, lubricating, or idling engines or other devices, or is labeled as fuel to power camping stoves or lights.

Therefore, sewing machine lubricant, camping fuels, and synthetic motor oil are “petroleum products” for the purposes of this regulation. Brake fluid, copier machine dispersant, antifreeze, cleaning solvents, and alcohol are not “petroleum products.”

(Added 1987) (Amended 1988)

2.12. Spot Label. – A spot label is a label clearly defined by means of a border, indentation, or other means that covers only a small portion of the surface of a principal display panel of a package; the entire portion of the principal display panel outside the area of the label contains no printed or graphic matter of any kind. A spot label may contain all required labeling information (identity, responsibility, and net contents), but it must at least indicate the identity and net contents. See Section 11.29. Spot Label for net contents placement exemption for a spot label.

(Added 1990) (Amended 1991)

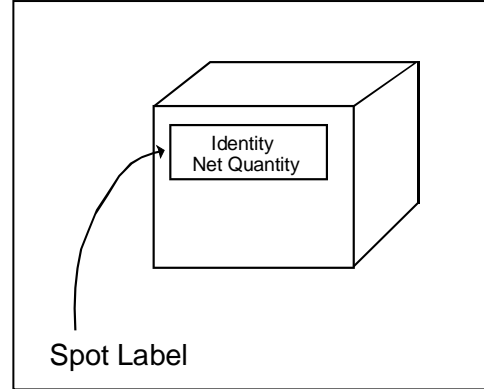

2.13. Header Strip. – A header label or header strip is a label that is attached across the top of a transparent or opaque bag or other container that bears no other printed or graphic material. See Section 11.30. Header Strip for net contents placement exemptions.

(Added 1990)

2.14. Standard Package. – A package that is one of a lot, shipment, or delivery of packages of the same commodity with identical net contents declarations.

Examples:

- 1 L bottles or 12 fl oz cans of carbonated soda,
- 500 g or 5 lb bags of sugar, or
- 100 m packages of rope

(Added 1991)

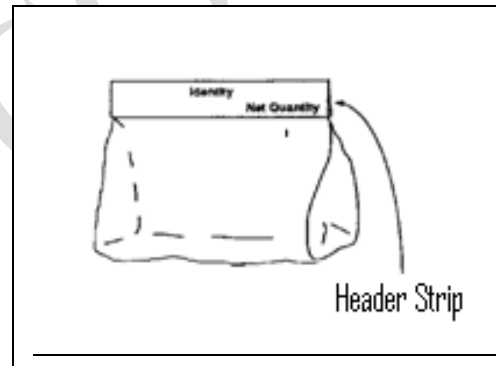

2.15. SI or SI Units. – SI or SI Units means the International System of Units as established in 1960 by the General Conference on Weights and Measures and interpreted or modified for the United States by the Secretary of Commerce. See the “Interpretation of the International System of Units for the United States” in the “Federal Register” (Volume 73, No. 96, pages 28432 to 28433) for May 16, 2008, and 15 United States Code, Section 205a - 2051 “Metric Conversion.” See also NIST Special Publication 330, *The International System of Units (SI)*, 2008 edition and NIST Special Publication 811, *Guide for the Use of the International System of Units (SI)*, 2008 edition that are available at www.nist.gov/pml/wmd/index.cfm or by contacting TheSI@nist.gov.

(Added 1993)

Section 3. Declaration of Identity: Consumer Package

3.1. Declaration of Identity: Consumer Package. – A separate declaration of identity ^[NOTE 2, page 64] on a consumer package shall appear on the principal display panel and shall not be misleading or deceptive. The identity shall be in terms of:

- (a) the name specified in or required by any applicable federal or state law or regulation or, in the absence of this;
- (b) the common or usual name or, in the absence of this;
- (c) the generic name or other appropriate description, including a statement of function (such as “cleaning powder”).

(Amended 1990) (Note added 1986)

NOTE 2: Section 19.(a) of the Uniform Weights and Measures Law (and 21 CFR 101.100 (b) (3) for non-meat and non-poultry foods) specifically exempts food packages from identity statements if the commodity is a food, other than meat or poultry, that was repackaged in a retail establishment and the food is displayed to the purchaser under either of the following circumstances: “(1) its interstate labeling is clearly in view or with a counter card, sign, or other appropriate device bearing prominently and conspicuously the common or usual name of the food, or (2) the common or usual name of the food is clearly revealed by its appearance.”

(Added 1986) (Amended 2001)

3.1.1. Parallel Identity Declaration: Consumer Package. – A declaration of the identity on a consumer package shall appear generally parallel to the base on which the package rests as it is designed to be displayed.

Section 4. Declaration of Identity: Non-consumer Package

A declaration of identity ^[NOTE 2, page 64] on a non-consumer package shall appear on the outside of a package and shall not be misleading or deceptive. The identity shall be in terms of:

- (a) the name specified in or required by any applicable federal or state law or regulation or, in the absence of this;
- (b) the common or usual name or, in the absence of this;
- (c) the generic name or other appropriate description, including a statement of function (such as “cleaning powder”).

(Amended 1990) (Note added 1986)

Section 5. Declaration of Responsibility: Consumer and Non-consumer Packages

Any package kept, offered, or exposed for sale, or sold at any place other than on the premises where packed shall specify conspicuously on the label of the package the name and address of the manufacturer, packer, or distributor. The name shall be the actual corporate name, or, when not incorporated, the name under which the business is conducted. The address shall include street address, city, state (or country if outside the United States), and ZIP Code (or the mailing code, if any, used in countries other than the United States); however, the street address may be omitted if this is shown in a current city directory or telephone directory.

If a person manufactures, packs, or distributes a commodity at a place other than his principal place of business, the label may state the principal place of business in lieu of the actual place where the commodity was manufactured or packed or is to be distributed, unless such statement would be misleading. Where the commodity is not manufactured by the person whose name appears on the label, the name shall be qualified by a phrase that reveals the connection such person has with such commodity, such as “Manufactured for and packed by _____,” “Distributed by _____,” or any other wording of similar import that expresses the facts.

Section 6. Declaration of Quantity: Consumer Packages

6.1. General. ^[NOTE 3, page 64] – The International System of Units (SI), known as the metric system and the inch-pound system of weights and measures are recognized as proper systems to be used in the declaration of quantity. Effective February 14, 1994, appropriate units of both systems shall be presented in a declaration of quantity except as specified in Section 11.32. SI Units, Exemptions for Consumer Commodities and Section 11.33 Inch-Pound Units, Exemptions - Consumer Commodities.

(Amended 1985, 1990, 1993, and 1999)

NOTE 3: Packages subject to this Section and/or the Federal Fair Packaging and Labeling Act shall be labeled in units of the International System of Units (SI) and the inch-pound system of measure effective February 14, 1994,

[except for seed (see Section 10.10. Packaged Seed) and camera film and recording tape (see Section 11.22. Camera Film, Video Recording Tape, Audio Recording Tape and Other Image and Audio Recording Media Intended for Retail Sale and Consumer Use), and as specified in Section 11.32. SI Units, Exemptions - Consumer Commodities]. SI units may appear first.

(Added 1982) (Amended 1990 and 1993)

6.2. Largest Whole Unit. – Where this regulation requires that the quantity declaration be in terms of the largest whole unit, the declaration shall, with respect to a particular package, be in terms of the largest whole unit of weight or measure with any remainder expressed (following the requirements of Section 6.5.2. (a) Fractions and Section 6.11. Fractions):

- (a) **SI Units.** – in decimal fractions of such largest whole unit.
- (b) **Inch-pound Units.**
 - (1) in common or decimal fractions of such largest whole unit; or
 - (2) in the next smaller whole unit or units with any further remainder in terms of common or decimal fractions of the smallest unit present in the quantity declaration.

6.3. Net Quantity. – A declaration of net quantity of the commodity in the package, exclusive of wrappers and any other material packed with such commodity (except as noted in Section 10.3. Aerosols and Similar Pressurized Containers), shall appear on the principal display panel of a consumer package and, unless otherwise specified in this regulation (see Sections 6.6. Prescribed Units, SI, through 6.9. Bi-dimensional Commodities), shall be in terms of the largest whole unit.

6.3.1. Use of “Net Mass” or “Net Weight.” – A quantity declaration may stand alone [e.g., “200 g (7 oz)” or “1 lb (453 g)”] or may include the term “net mass” or “net weight” either preceding or following the declaration. The term “net” by itself may be used on food labels. However, the quantity of contents shall always declare the net quantity of contents even when such terms are not used.

(Amended 1993)

6.3.2. Lines of Print or Type. – A declaration of quantity may appear on one or more lines of print or type.

(Amended 1982)

6.4. Terms: Weight, Measure, Volume, or Count. – The declaration of the quantity of a particular commodity shall be expressed in terms of:

- (a) weight if the commodity is solid, semisolid, viscous, or a mixture of solid and liquid;
- (b) volume measure if the commodity is liquid or dry, if the commodity is dry;
- (c) linear measure or area; or
- (d) numerical count.

However, if there exists a firmly established general consumer usage and trade custom with respect to the terms used in expressing a declaration of quantity of a particular commodity, such a declaration of quantity may be expressed in its traditional terms, provided such traditional declaration gives accurate and adequate information as to the quantity of the commodity. Any net content statement that does not permit price and quantity comparisons is forbidden.

(Amended 1989)

6.4.1. Combination Declaration.

- (a) A declaration of quantity in terms of weight or volume shall be combined with appropriate declarations of the measure, count, and size of the individual units unless a declaration of weight alone is fully informative.
- (b) A declaration of quantity in terms of measure shall be combined with appropriate declarations of the weight, volume, count, and size of the individual units unless a declaration of measure alone is fully informative.
- (c) A declaration of quantity in terms of count shall be combined with appropriate declarations of the weight, volume, measure, and size of the individual units unless a declaration of count alone is fully informative.

(Added 1971)

6.5. SI Units: Mass, Measure. ^[NOTE 3, page 64] – A declaration of quantity:

- (a) in units of mass shall be the kilogram, gram, or milligram;
- (b) in units of liquid measure shall be the liter or milliliter and shall express the volume at 20 °C, except in the case of petroleum products or distilled spirits, for which the declaration shall express the volume at 15.6 °C, and except also in the case of a commodity that is normally sold and consumed while frozen, for which the declaration shall express the volume at the frozen temperature, and except also in the case of malt beverages or a commodity that must be maintained in the refrigerated state, for which the declaration shall express the volume at 4 °C;
(Amended 1985 and 1990)
- (c) in units of linear measure shall be the meter, centimeter, or millimeter;
- (d) in units of area measure shall be the square meter, square decimeters, square centimeter, or square millimeter;
- (e) in units of volume other than liquid measure shall be the liter and milliliter, except that the units cubic meter and cubic centimeter shall be used only when specifically designated as a method of sale;
- (f) Rule of 1000. – The selected multiple or submultiple prefixes for SI units shall result in numerical values between 1 and 1000. This rule allows centimeters or millimeters to be used where a length declaration is less than 100 centimeters.

Examples:

500 g, not 0.5 kg;
1.96 kg, not 1960 g;
750 mL, not 0.75 L; or
750 mm or 75 cm, not 0.75 m

(Added 1993)

- (g) SI declarations should be shown in three digits except where the quantity is below 100 grams, milliliters, centimeters, square centimeters, or cubic centimeters, where it may be shown in two digits. In either case, any final zero appearing to the right of the decimal point need not be shown; and

(Added 1993)

- (h) the declaration of net quantity of contents shall not be expressed in mixed units.

Example:

1.5 kg, not 1 kg 500 g.

(Added 1993)

6.5.1. Symbols. – Any of the following symbols for SI units, and none other, may be employed in the quantity statement on a package of commodity:

| | | | |
|-------------------|-----------------|------------------|-----------------|
| centimeter | cm | cubic meter | m ³ |
| cubic centimeter | cm ³ | kilogram | kg |
| meter | m | gram | g |
| milligram | mg | millimeter | mm |
| liter | L or l | square meter | m ² |
| milliliter | mL or ml | cubic decimeter | dm ³ |
| square centimeter | cm ² | square decimeter | dm ² |
| micrometer | µm | microgram | µg or mcg |

- (a) Symbols ^[NOTE 4, page 67], except for liter, are not capitalized unless the unit is derived from a proper name. Periods shall not be used after the symbol. Symbols shall always be written in the singular form. Adding “s” to an SI symbol to express the plural of the symbol is prohibited.
- (b) The “L” symbol and the “mL” symbol are preferred; however, the “l” symbol for liter and “ml” symbol for milliliter are permitted.
(Amended 1980 and 1993)

NOTE 4: The “e” mark shall not be considered to be a qualifying word or phrase and may be used as part of the statement of the net quantity of contents where warranted. When used, the “e” mark shall be at least 3 mm (approximately 1/8 in) in height. The term “e” mark refers to the symbol “e” used in connection with the quantity declarations on labels of some consumer commodities marketed primarily in the European Union (EU). The “e” mark constitutes a representation by the packer or importer that the package to which it is applied has been filled in accordance with the average system of quantity specified by the EU. The average system is a method of declaring package fill in the EU and other countries of the world, including the United States.

(Added 1993)

6.5.2. Fractions and Prefixes.

- (a) **Fractions:** An SI statement in a declaration of net quantity of contents of any consumer commodity may contain only decimal fractions.
- (b) **Prefixes:** The following chart indicates SI prefixes that may be used on a broad range of consumer commodity labels to form multiples and submultiples of SI units:

| Prefix | Symbol | Multiplying Factor* |
|------------|--------|---------------------|
| kilo- | k | $\times 10^3$ |
| deka-** | da | $\times 10$ |
| deci-** | d | $\times 10^{-1}$ |
| centi-*** | c | $\times 10^{-2}$ |
| milli- | m | $\times 10^{-3}$ |
| micro-**** | μ | $\times 10^{-6}$ |

* $10^2 = 100$; $10^3 = 1000$; $10^{-1} = 0.1$; $10^{-2} = 0.01$

Thus, 2 kg = 2 \times 1000 g = 2000 g and 3 cm = 3 \times 0.01 m = 0.03 m

**Not permitted on food labels.

***Should only be used with “meter.”

****Shall only be used for measurements less than 1 mm.

(Amended 1993)

6.6. Prescribed Units, SI. [NOTE 3, page 64]

6.6.1. Less than 1 Meter, 1 Square Meter, 1 Kilogram, 1 Cubic Meter, or 1 Liter. – The declaration of quantity shall be expressed as follows:

- length measure of less than 1 meter: in centimeters or millimeters;
(Amended 1979)
- area measure of less than 1 m²: in square decimeters and decimal fractions of a square decimeter or in square centimeters and decimal fractions of a square centimeter;
- mass of less than 1 kg: in grams and decimal fractions of a gram, but if less than 1 g, then in milligrams;
- liquid or dry measure of less than 1 L: in milliliters; and
- cubic measure less than 1 m³: in cubic centimeters or cubic decimeters (liters) ~~[See Section 10.11. Cubic Measure in Compressed Form];~~ ;
(Added 1993)

provided the quantity declaration appearing on a random mass package may be expressed in units of decimal fractions of the largest appropriate unit, the fraction being carried out to not more than three decimal places.

(Amended 1980 and 1993)

6.6.2. One Meter, 1 Square Meter, 1 Kilogram, 1 Liter, 1 Cubic Meter, or More. – In the case of:

- length measure of 1 m or more: in meters and decimal fractions to not more than three places;
- area measure of 1 m² or more: in square meters and decimal fractions to not more than three places;
- mass of 1 kg or more: in kilograms and decimal fractions to not more than three places;
- liquid or dry measure of 1 L or more: in liters and decimal fractions to not more than three places; and
(Added 1986) (Amended 1993)
- cubic measure of 1 m³ or more: in cubic meters and decimal fractions to not more than three places.
(Added 1993)

6.7. Inch-Pound Units: Weight, Measure. – A declaration of quantity:

- (a) in units of weight shall be in terms of the avoirdupois pound or ounce;
- (b) in units of liquid measure shall be in terms of the United States gallon of 231 in³ or liquid quart, liquid pint, or fluid-ounce subdivisions of the gallon and shall express the volume at 68 °F, except in the case of petroleum products and distilled spirits, for which the declaration shall express the volume at 60 °F, and except also in the case of a commodity that is normally sold and consumed while frozen, for which the declaration shall express the volume at the frozen temperature, and except also in the case of a commodity that must be maintained in the refrigerated state, for which the declaration shall express the volume at 40 °F, and except also in the case of malt beverages, for which the declaration shall express the volume at 39.1 °F;
(Amended 1985 and 1990)
- (c) in units of linear measure shall be in terms of the yard, foot, or inch;
- (d) in units of area measure shall be in terms of the square yard, square foot, or square inch;
- (e) in units of volume measure shall be in terms of the cubic yard, cubic foot, or cubic inch; and
- (f) in units of dry measure shall be in terms of the United States bushel of 2150.42 in³, or peck, dry quart, and dry pint subdivisions of the bushel.

6.7.1. Symbols and Abbreviations. – Any of the following symbols and abbreviations, and none other, shall be employed in the quantity statement on a package of commodity:

| | | | |
|--------------|------|---------|----|
| avoirdupois | avdp | ounce | oz |
| piece | pc | count | ct |
| pint | pt | cubic | cu |
| pound | lb | each | ea |
| feet or foot | ft | quart | qt |
| fluid | fl | square | sq |
| gallon | gal | weight | wt |
| inch | in | yard | yd |
| liquid | liq | drained | dr |
| diameter | dia | | |

A period should not be used after the abbreviation. Abbreviations should be written in singular form; and “s” should not be added to express the plural. (For example, “oz” is the symbol for both “ounce” and “ounces.”) Both upper and lower case letters are acceptable.

(Added 1974) (Amended 1980, 1990, and 1993)

6.7.2. Units of Two or More Meanings. – When the term “ounce” is employed in a declaration of liquid quantity, the declaration shall identify the particular meaning of the term by the use of the term “fluid;” however, such distinction may be omitted when, by association of terms (for example, as in “1 pint 4 ounces”), the proper meaning is obvious. Whenever the declaration of quantity is in terms of the dry pint or dry quart, the declaration shall include the word “dry.”

(Amended 1982)

6.8. Prescribed Units, Inch-pound System.

6.8.1. Less than 1 foot, 1 square foot, 1 pound, or 1 pint. – The declaration of quantity shall be expressed in the following terms:

- (a) in the case of length measure of less than 1 ft, in inches and fractions of inches;

- (b) in the case of area measure of less than 1 ft², in square inches and fractions of square inches;
- (c) in the case of weight of less than 1 lb, in ounces and fractions of ounces; and
- (d) in the case of liquid measure of less than 1 pt, in fluid ounces and fractions of fluid ounces, provided, the quantity declaration appearing on a random package may be expressed in terms of decimal fractions of the largest appropriate unit, the fraction being carried out to not more than three decimal places.

(Amended 1984)

6.8.2. One Foot, 1 Square Foot, 1 Pound, 1 Pint, 1 Gallon, or More. – The declaration of quantity shall be expressed in the following terms (see Section 6.2. Largest Whole Unit and Section 6.11. Fractions):

- (a) **Linear Measure.** – If 1 ft or more, expressed in terms of the largest whole unit (a yard or a foot) with any remainder expressed in inches and fractions of the inch or in fractions of the foot or yard, except that it shall be optional to include a statement of length in terms of inches.
- (b) **Area Measure.**
 - (1) If 1 ft² or more, but less than 4 ft², expressed in square feet with any remainder expressed in square inches and fractions of a square inch or in fractions of a square foot; and
 - (2) If 4 ft² or more, expressed in terms of the largest whole unit (e.g., square yards or square feet) with any remainder expressed in square inches and fractions of a square inch or in fractions of the square foot or square yard.
- (c) **Weight.** – If 1 lb or more, expressed in terms of the largest whole unit with any remainder expressed in ounces and fractions of an ounce or in fractions of the pound.
- (d) **Liquid Volume.**
 - (1) If 1 pt or more, but less than 1 gal, expressed in the largest whole unit (quarts, quarts and pints, or pints, as appropriate) with any remainder expressed in fluid ounces or fractions of the pint or quart, except that 2 qt may be declared as ½ gal, and it shall be optional to include an additional expression of net quantity in fluid ounces; or
 - (2) If 1 gal or more, expressed in terms of the largest whole unit (gallons followed by fractions of a gallon or by the next smaller whole unit or units [for example, quarts and pints]) with any remainder expressed in fluid ounces or fractions of the pint or quart, except that it shall be optional to include an additional expression of net quantity in fluid ounces.
- (e) **Dry Measure.** – If 1 dry pt or more, expressed in terms of the largest whole unit with the remainder expressed in fractions of a dry pint, dry quart, peck, or bushel, provided the quantity declaration on a random package may be expressed in decimal fractions of the largest appropriate unit carried out to not more than three decimal places.

(Amended 1993)

6.9. Bi-dimensional Commodities. – For bi-dimensional commodities (including roll-type commodities) the quantity declaration shall be expressed in both SI and inch-pound units of measurement as follows:

- (a) if the area is less than 929 cm² (1 ft²), in terms of length and width (expressed in the largest whole unit for SI and in linear inches and fractions of linear inches for inch-pound);

Example:

20.3 cm x 25.4 cm (8 in x 10 in);

- (b) if the area is at least 929 cm² (1 ft²), but less than 37.1 dm² (4 ft²), in terms of area (expressed in the largest whole unit for SI and in square inches for inch-pound), followed by a declaration of the length and width in terms of the largest whole unit:

Example:

31 dm² (49 cm x 64 cm) 3.36 ft² (1.6 ft x 2.1 ft), provided:

- (1) bi-dimensional commodities having a width of 10 cm (4 in) or less, the declaration of net quantity shall be expressed in terms of width and length in linear measure; no declaration of area is required;
- (2) an inch-pound dimension of less than 2 ft may be stated in inches;
- (3) commodities consisting of usable individual units (e.g., paper napkins) require a declaration of unit area but not a declaration of total area of all such units (except roll-type commodities with individual usable units created by perforations, for which see Section 6.10. Count: Ply); and
- (4) inch-pound declarations may include after the statement of the linear dimensions in the largest whole unit a parenthetical declaration of the same dimensions in inches.

Example:

25 ft² (12 in x 8.33 yd) (12 in x 300 in).

- (c) if the area is 37.1 dm² (4 ft²) or more, in terms of area (expressed in the largest whole unit for SI and in square feet for inch-pound), followed by a declaration of the length and width, in terms of the largest whole unit, provided:
- (1) no declaration of area is required for a bi-dimensional commodity with a width of 10 cm (4 in) or less;
 - (2) bi-dimensional commodities with a width of 10 cm (4 in) or less, the inch-pound statement of width shall be expressed in terms of linear inches and fractions thereof, and length shall be expressed in the largest whole unit (yard or foot) with any remainder in terms of fractions of the yard or foot, except that it shall be optional to express the length in the largest whole unit followed by a statement of length in inches or to express the length in inches followed by a statement of length in the largest whole unit;

Examples:

5 cm x 9.14 m (2 in x 10 yd); or
5 cm x 9.14 m (2 in x 10 yd) (360 in); or
5 cm x 9.14 m (2 in x 360 in) (10 yd).

- (3) an inch-pound dimension of less than 2 ft may be stated in inches; and
- (d) no declaration of area is required for commodities for which the length and width measurements are critical in terms of end use (such as wallpaper border) if such commodities clearly present the length and width measurements on the label.

6.10. Count: Ply. – If the commodity is in individually usable units of one or more components or plies, the quantity declaration shall, in addition to complying with other applicable quantity declaration requirements of this regulation, include the number of plies and total number of usable units.

Roll type commodities, when perforated so as to identify individual usable units, shall not be deemed to be made up of usable units; however, such roll type commodities shall be labeled in terms of:

- (a) total area measurement;

- (b) number of plies;
 - (c) count of usable units; and
 - (d) dimensions of a single usable unit.
- (Amended 1988)

6.11. Fractions.

- (a) **Inch-pound:** An inch-pound statement of net quantity of contents of any consumer commodity may contain common or decimal fractions. A common fraction shall be in terms of halves, quarters, eighths, sixteenths, or thirty-seconds, except that:
 - (1) if there exists a firmly established general consumer usage and trade custom of employing different common fractions in the net quantity declaration of a particular commodity, they may be employed; and
 - (2) if linear measurements are required in terms of yards or feet, common fractions may be in terms of thirds.
- (b) **Common fractions:** A common fraction shall be reduced to its lowest term.

Example: $\frac{2}{4}$ becomes $\frac{1}{2}$

- (c) **Decimal fractions:** A decimal fraction shall not be carried out to more than three places.
- (Amended 1986 and 1993)

6.12. Supplementary Quantity Declarations. – The required quantity declaration may be supplemented by one or more declarations of weight, measure, or count, such declaration appearing other than on a principal display panel. Such supplemental statement of quantity of contents shall not include any term qualifying a unit of weight, measure, or count that tends to exaggerate the amount of commodity contained in the package (e.g., “giant” quart, “larger” liter, “full” gallon, “when packed,” “minimum,” or words of similar import).

6.13. Rounding. ^[NOTE 5, page 72] – In all conversions for the purpose of showing an equivalent SI or inch-pound quantity to a rounded inch-pound or SI quantity, or in calculated values to be declared in the net quantity statement, the number of significant digits retained must be such that accuracy is neither sacrificed nor exaggerated. Conversions, the proper use of significant digits, and rounding must be based on the packer’s knowledge of the accuracy of the original measurement that is being converted. In no case shall rounded net contents declarations overstate a quantity; the packer may round converted values down to avoid overstating the net contents.

(Amended 1993)

NOTE 5: When as a result of rounding SI or customary inch-pound declarations the resulting declarations are not exact, the largest declaration (either metric or inch-pound) will be used for enforcement purposes to determine whether a package contains at least the declared amount of the product.

6.14. Qualification of Declaration Prohibited. – In no case shall any declaration of quantity be qualified by the addition of the words “when packed,” “minimum,” or “not less than” or any words of similar import (e.g., “approximately”), nor shall any unit of weight, measure, or count be qualified by any term (such as “jumbo,” “giant,” “full,” or the like) that tends to exaggerate the amount of commodity.

(Amended 1998)

6.15. Character of Declaration: Average. – The average quantity of contents in the packages of a particular lot, shipment, or delivery shall at least equal the declared quantity, and no unreasonable shortage in any package shall be

permitted even though overages in other packages in the same shipment, delivery, or lot compensate for such shortage.

(Added 1981)

6.16. Random Packages. – A random weight package must bear a label conspicuously declaring:

- (a) the net weight;
- (b) unit price; and
- (c) the total price.

In the case of a random package packed at one place for subsequent sale at another, neither the price per unit of weight nor the total selling price need appear on the package, provided the package label includes both such prices at the time it is offered or exposed for sale at retail.

(Added 1999)

Section 7. Declaration of Quantity: Non-consumer Packages

7.1. General. – The SI and inch-pound systems of weights and measures are recognized as proper systems to be used in the declaration of quantity. Units of both systems may be combined in a dual declaration of quantity. ^[NOTE 6, page 73] (See Section 6.3. Net Quantity, and Section 6.3.1. Use of “Net Mass” or “Net Weight.”)

NOTE 6: Although non-consumer packages under this Regulation may bear SI declarations only, this Regulation should not be construed to supersede any labeling requirement specified in federal law.

7.2. Location. – A non-consumer package shall bear on the outside a declaration of the net quantity of contents. Such declaration shall be in terms of the largest whole unit (see Section 6.2. Largest Whole Unit; for small packages, see Section 11.16. Small Packages).

7.3. Terms: Weight, Liquid Measure, Dry Measure, or Count. – The declaration of the quantity of a particular commodity shall be expressed in terms of liquid measure if the commodity is liquid, in terms of dry measure if the commodity is dry, in terms of weight if the commodity is solid, semisolid, viscous, or a mixture of solid and liquid, or in terms of numerical count. However, if there exists a firmly established general consumer usage and trade custom with respect to the terms used in expressing a declaration of quantity of a particular commodity, such declaration of quantity may be expressed in its traditional terms if such traditional declaration gives accurate and adequate information as to the quantity of the commodity.

7.4. SI Units: Mass, Measure. – A declaration of quantity:

- (a) in units of mass shall be in terms of the kilogram, gram, or milligram;
- (b) in units of liquid measure shall be in terms of the liter or milliliter, and shall express the volume at 20 °C, except in the case of petroleum products or distilled spirits, for which the declaration shall express the volume at 15.6 °C, and except also in the case of a commodity that is normally sold and consumed while frozen, for which the declaration shall express the volume at the frozen temperature, and except also in the case of malt beverages or a commodity that is normally sold in the refrigerated state, for which the declaration shall express the volume at 4 °C;
(Amended 1985)
- (c) in units of linear measure shall be in terms of the meter, centimeter, or millimeter;
- (d) in units of area measure shall be in terms of the square meter, square decimeter, square centimeter or square millimeter;

- (e) in units of volume other than liquid measure shall be in terms of the liter and milliliter, except that the terms cubic meter, cubic decimeter, and cubic centimeter will be used only when specifically designated as a method of sale;
- (f) Rule of 1000. – The selected multiple or submultiple prefixes for SI units shall result in numerical values between 1 and 1000. This rule allows centimeters or millimeters to be used where a length declaration is less than 100 centimeters;

Examples:

500 g, not 0.5 kg;
 1.96 kg, not 1960 g;
 750 mL, not 0.75 L; or
 750 mm or 75 cm, not 0.75 m;

(Added 1993)

- (g) SI declarations should be shown in three digits except where the quantity is below 100 grams, milliliters, centimeters, square centimeters, or cubic centimeters where it can be shown in two digits. In either case, any final zero appearing to the right of the decimal point need not be shown; and

(Added 1993)

- (h) the declaration of net quantity of contents shall not be expressed in mixed units.

Example:

1.5 kg, not 1 kg 500 g

7.4.1. Symbols. – Only those symbols as detailed in Section 6.5.1. Symbols, and none other, may be employed in the quantity statement on a package of commodity.

7.5. Inch-pound Units: Weight, Measure. – A declaration of quantity:

- (a) in units of weight shall be in terms of the avoirdupois pound or ounce;
- (b) in units of liquid measure shall be in terms of the United States gallon of 231 cubic inches or liquid quart, liquid pint, or fluid ounce subdivisions of the gallon and shall express the volume at 68 °F, except in the case of petroleum products or distilled spirits, for which the declaration shall express the volume at 60 °F, and except also in the case of a commodity that is normally sold and consumed while frozen, for which the declaration shall express the volume at the frozen temperature, and except also in the case of a commodity that is normally sold in the refrigerated state, for which the declaration shall express the volume at 40 °F, and except also in the case of malt beverages, for which the declaration shall express the volume at 39.1 °F;
 (Amended 1985)

- (c) in units of linear measure shall be in terms of the yard, foot, or inch;
- (d) in units of area measure shall be in terms of the square yard, square foot, or square inch;
- (e) in units of volume measure shall be in terms of the cubic yard, cubic foot, or cubic inch; and
- (f) in units of dry measure, shall be in terms of the United States bushel of 2150.42 in³, or peck, dry quart, and dry pint subdivisions of the bushel.

7.5.1. Symbols and Abbreviations. – Any generally accepted symbol and abbreviation of a unit name may be employed in the quantity statement on a package of commodity. (For commonly accepted symbols and abbreviations, see Section 6.7.1. Symbols and Abbreviations.)

7.6. Character of Declaration: Average. – The average quantity of contents in the packages of a particular lot, shipment, or delivery shall at least equal the declared quantity, and no unreasonable shortage in any package shall be permitted, even though overages in other packages in the same shipment, delivery, or lot compensate for such shortage.

Section 8. Prominence and Placement: Consumer Packages

8.1. General. – All information required to appear on a consumer package shall appear thereon in the English language and shall be prominent, definite, plain, and conspicuous as to size and style of letters and numbers and as to color of letters and numbers in contrast to color of background. Any required information that is either in hand lettering or hand script shall be entirely clear and equal to printing in legibility.

8.1.1. Location. – The declaration or declarations of quantity of the contents of a package shall appear in the bottom 30 % of the principal display panel or panels. For cylindrical containers, see also

Section 10.7. Cylindrical Containers for additional requirements. For small packages, see Section 11.16. Small Packages.

(Amended 1975)

8.1.2. Style of Type or Lettering. – The declaration or declarations of quantity shall be in such a style of type or lettering as to be boldly, clearly, and conspicuously presented with respect to other type, lettering, or graphic material on the package, except that a declaration of net quantity blown, formed, or molded on a glass or plastic surface is permissible when all label information is blown, formed, or molded on the surface.

8.1.3. Color Contrast. – The declaration or declarations of quantity shall be in a color that contrasts conspicuously with its background, except that a declaration of net quantity blown, formed, or molded on a glass or plastic surface shall not be required to be presented in a contrasting color if no required label information is on the surface in a contrasting color.

8.1.4. Free Area. – The area surrounding the quantity declaration shall be free of printed information:

- (a) above and below, by a space equal to at least the height of the lettering in the declaration; and
- (b) to the left and right, by a space equal to twice the width of the letter “N” of the style and size of type used in the declaration.

8.1.5. Parallel Quantity Declaration. – The quantity declaration shall be presented in such a manner as to be generally parallel to the declaration of identity and to the base on which the package rests as it is designed to be displayed.

8.2. Calculation of Area of Principal Display Panel for Purposes of Type Size. – The area of the principal display panel shall be:

- (a) in the case of a rectangular container, one entire side that properly can be considered to be the principal display panel, the product of the height times the width of that side;

For Figure 3, the area of the principal display panel is 20 cm (8 in) x 15 cm (6 in) = 300 cm² (48 in²).

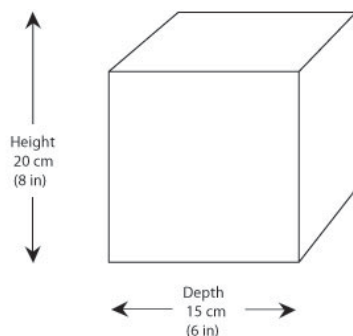

Figure 3.

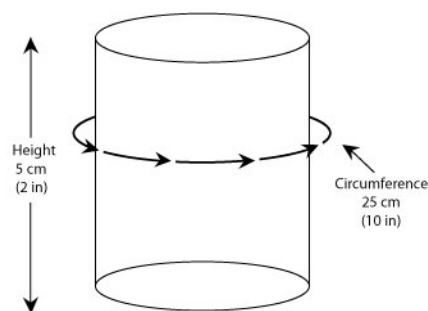

Figure 4.

- (b) in the case of a cylindrical or nearly cylindrical container, 40 % of the product of the height of the container times the circumference;

For Figure 4, the area of the principal display panel is:
 $25 \text{ cm (10 in)} \times 5 \text{ cm (2 in)} = 125 \text{ cm}^2 (20 \text{ in}^2) \times 0.40 = 50 \text{ cm}^2 (8 \text{ in}^2)$
 (see also Section 10.7. Cylindrical Containers).

The area of the principal display panel is the same in both examples. The declaration of net quantity of contents must be of the same height in both cases. It is not the size of the label that is used to determine the minimum type size of the quantity statement, but the size of the surface of the package exposed to view to the customer. The package on the right side of the figure has a spot label (see Section 2.12. Spot Label and Section 11.29. Spot Label); and

- (c) in the case of any other shaped container, 40 % of the total surface of the container, unless such container presents an obvious principal display panel (e.g., the top of a triangular or circular package of cheese, or the top of a can of shoe polish), in which event the area shall consist of the entire such surface.

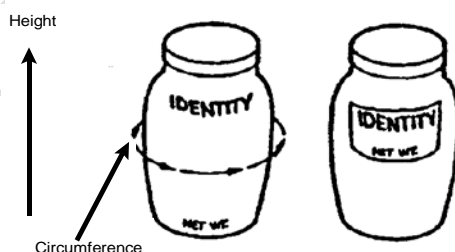

Figure 5.

Determination of the principal display panel shall exclude tops, bottoms, flanges at tops and bottoms of cans, and shoulders and necks of bottles or jars.

8.2.1. Minimum Height of Numbers and Letters. – The height of any letter or number in the required quantity declaration shall be not less than that shown in Table 1 with respect to the area of the panel, and the height of each number of a common fraction shall meet one-half the minimum height standards. When upper and lowercase or all lowercase letters are used, it is the lowercase “o” or its equivalent that shall meet the minimum height requirement. When upper and lowercase or all lowercase letters are used in SI symbols, it is the uppercase “L,” lowercase “d,” or their equivalent in the print or type that shall meet the minimum height requirement. However, no letter shall be less than 1.6 mm ($1/16$ in) in height. Other letters and exponents must be presented in the same type style and in proportion to the type size used.

(Amended 1993)

8.2.2. Numbers and Letters: Proportion. – No number or letter shall be more than three times as high as it is wide.

| Table 1. Minimum Height of Numbers and Letters | | |
|---|--|--|
| Area of Principal Display Panel | Minimum Height of Numbers and Letters | Minimum Height; Label Information Blown, Formed, or Molded on Surface of Container |
| ≤ 32 cm ² (5 in ²) | 1.6 mm (¹ / ₁₆ in) | 3.2 mm (¹ / ₈ in) |
| > 32 cm ² (5 in ²) ≤ 161 cm ² (25 in ²) | 3.2 mm (¹ / ₈ in) | 4.8 mm (³ / ₁₆ in) |
| > 161 cm ² (25 in ²) ≤ 645 cm ² (100 in ²) | 4.8 mm (³ / ₁₆ in) | 6.4 mm (¹ / ₄ in) |
| > 645 cm ² (100 in ²) 2581 cm ² (400 in ²) | 6.4 mm (¹ / ₄ in) | 7.9 mm (⁵ / ₁₆ in) |
| > 2581 cm ² (400 in ²) | 12.7 mm (¹ / ₂ in) | 14.3 mm (⁹ / ₁₆ in) |

Symbols: ≤ means less than or equal to; < means less than; > means greater than.
NOTE: The type size requirements specified in this table do not apply to the “e” mark [NOTE 4, page 67].

Section 9. Prominence and Placement: Non-consumer Packages

9.1. General. – All information required to appear on a non-consumer package shall be definitely and clearly stated thereon in the English language. Any required information that is either in hand lettering or hand script shall be entirely clear and equal to printing in legibility.

Section 10. Requirements: Specific Consumer Commodities, Non-consumer Commodities, Packages, Containers

(Title amended 1979)

10.1. Display Card Package. – For an individual package affixed to a display card, or for a commodity and display card together comprising a package, the type size of the quantity declaration is governed by the dimensions of the display card.

10.2. Eggs. – When cartons containing 12 eggs have been designed so as to permit division in half by the retail purchaser, the required quantity declaration shall be so positioned as to have its context destroyed when the carton is divided.

10.3. Aerosols and Similar Pressurized Containers. – The declaration of quantity on an aerosol package and on a similar pressurized package shall disclose the net quantity of the commodity (including propellant), in terms of weight, that will be expelled when the instructions for use as shown on the container are followed.

10.4. Multi-unit Packages. [NOTE 7, page 78] – Any package containing more than one individual “commodity in package form” (see Section 2.1. Package) of the same commodity shall bear on the outside of the package a declaration of:

- (a) the number of individual units;
- (b) the quantity of each individual unit; and

- (c) the total quantity of the contents of the multi-unit package.

Example:

Soap bars, 6 Bars, Net Wt 100 g (3.53 oz) each
Total Net Wt 600 g (1.32 lb).

The term “total” or the phrase “total contents” may precede the quantity declaration.

A multi-unit package containing unlabeled individual packages which are not intended for retail sale separate from the multi-unit package may contain, in lieu of the requirements of section (a), a declaration of quantity of contents expressing the total quantity of the multi-unit package without regard for inner packaging. For such multi-unit packages it shall be optional to include a statement of the number of individual packages when such a statement is not otherwise required by the regulations.

Examples:

Deodorant Cakes:

5 Cakes, Net Wt 113 g (4 oz) each, Total Net Wt 566 g (1.25 lb); or
5 Cakes, Total Net Wt 566 g (1 lb 4 oz)

Soap Packets:

10 Packets, Net Wt 56.6 g (2 oz) each, Total Net Wt 566 g (1.25 lb); or Net Wt 566 g (1 lb 4 oz); or
10 Packets, Total Net Wt 566 g (1 lb 4 oz)

(Amended 1993)

NOTE 7: For foods, a “multi-unit” package means a package containing two or more individually packaged units of the identical commodity in the same quantity, intended to be sold as part of the multi-unit package but labeled to be individually sold in full compliance with this regulation. Open multi-unit retail food packages under the authority of the FDA or the USDA that do not obscure the number of units or prevent examination of the labeling on each of the individual units are not required to declare the number of individual units or the total quantity of contents of the multi-unit package if the labeling of each individual unit complies with requirements so that it is capable of being sold individually. (See also Section 11.11. Soft Drink Bottles and Section 11.12. Multi-Unit Soft-Drink Bottles.)

(Added 1984)

10.5. Combination Packages. – A combination package is a package intended for retail sale, containing two or more individual packages or units of dissimilar commodities. The declaration of net quantity for a combination package shall contain an expression of weight, volume, measure, or count or a combination thereof, as appropriate, for each individual package or unit, provided the quantity statements for identical packages or units shall be combined. This section does not apply to food or other commodities subject to the Federal Food, Drug, and Cosmetic Act (21 USC).

Examples:

Lighter Fluid and Flints –

2 cans lighter fluid – each 236 mL (8 fl oz)
1 package – 8 flints

Sponges and Cleaner –

2 sponges – each 10 cm x 15 cm x 2.5 cm (4 in x 6 in x 1 in)
1 box cleaner – Net Mass 170 g (6 oz)

Picnic Pack –

20 spoons, 10 knives, and 10 forks
10 2-ply napkins 25 cm x 25 cm (10 in x 10 in)
10 cups – 177 mL (6 fl oz)

(Amended 1993)

10.6. Variety Packages. – A variety package is a package intended for retail sale, containing two or more individual packages or units of similar but not identical commodities. Commodities that are generically the same but that differ in weight, measure, volume, appearance, or quality are considered similar but not identical. This section does not apply to foods or other commodities subject to the Federal Food, Drug, and Cosmetic Act (21 USC). The declaration of net quantity for a variety package will be expressed as follows:

- (a) the number of units for each identical commodity followed by the weight, volume, or measure of that commodity;
- (b) the total quantity by weight, volume, measure, and count, as appropriate, of the variety package. The statement of total quantity shall appear as the last item in the declaration of net quantity and shall not be of greater prominence than other terms used.

Examples:

Sponges –

11 Sponges 11 cm x 20.3 cm x 1.9 cm (4 in x 8 in x ¾ in)

14 Sponges 5.7 cm x 10 cm x 1.2 cm (2¼ in x 4 in x ½ in)

Total: 25 Sponges

Soap –

2 Soap Bars 85 g (3 oz) ea

1 Soap Bar 142 g (5 oz)

Total: 3 Soap Bars 312 g (11 oz)

Liquid Shoe Polish –

1 Brown 89 mL (3 fl oz)

1 Black 89 mL (3 fl oz)

1 White 148 mL (5 fl oz)

Total: 326 mL (11 fl oz)

Picnic Ware –

34 spoons

33 forks

33 knives

Total: 100 pieces

(Amended 1993)

When individual units in a variety package are either packaged or labeled and are intended for retail sale as individual units, each unit shall be labeled in compliance with the applicable sections of this regulation.

10.7. Cylindrical Containers. – In the case of cylindrical or nearly cylindrical containers, information required to appear on the principal display panel shall appear within that 40 % of the circumference which is most likely to be displayed, presented, shown, or examined under customary conditions of display for retail sale.

10.8. Measurement of Container-Type Commodities, How Expressed.

10.8.1. General. – Commodities designated and sold at retail to be used as containers for other materials or objects, such as bags, cups, boxes, and pans, shall be labeled with the declaration of net quantity as follows:

- (a) For bag-type commodities, in terms of count followed by linear dimensions of the bag (whether packaged in a perforated roll or otherwise). The linear dimensions shall be expressed:
 - (1) in SI units: in millimeters or centimeters, except that a dimension of 1 meter or more will be expressed in meters with the remainder in terms of decimal fractions of the meter; and

- (2) in inch-pound units: in inches, except that a dimension of 2 ft or more will be expressed in feet with any remainder in terms of inches or common or decimal fractions of the foot.
- (b) When the unit bag is characterized by two dimensions because of the absence of a gusset, the width and length will be stated.

Examples:

25 Bags, 12.7 cm x 10 cm (5 in x 4 in) or
50 Bags, 75 cm x 1.2 m (2.5 ft x 3.9 ft)

- (c) When the unit bag is gusseted, the dimensions will be expressed as width, depth, and length.

Examples:

25 Bags, 43 cm x 10 cm x 50 cm (17 in x 4 in x 20 in) or
100 Bags, 50.8 cm x 30.4 cm x 76.2 cm (20 in x 12 in x 2½ ft)

- (d) For other square, oblong, rectangular, or similarly shaped containers, in terms of count followed by length, width, and depth, except depth need not be listed when less than 5 cm or 2 in. The linear dimensions shall be expressed as specified in Section 10.8.1.(a).

Example:

bag-type commodities: 2 Pans, 20 cm x 20 cm (8 in x 8 in)

- (e) For circular or other generally round-shaped containers, except cups and the like, in terms of count followed by diameter and depth, except depth need not be listed when less than 5 cm or 2 in.

Example:

4 Pans, 20 cm (8 in) diameter x 10 cm (4 in)

- (f) Cups – Notwithstanding the above requirements, the net quantity statement for containers such as cups will be listed in terms of count and liquid capacity per unit.

Example:

24 Cups, 177 mL (6 fl oz) capacity

10.8.2. Capacity. – When the functional use of the container is related by label references in standard terms of measure to the capability of holding a specific quantity of substance or class of substances such references shall be a part of the net quantity statement and shall specify capacity as follows:

- (a) in SI units: in terms of volume for all containers and liners. The expressed capacity will be stated in terms of milliliters, except that a quantity of 1 liter or more shall be expressed in liters with the remainder in terms of decimal fractions of the liter; and

- (b) in inch-pound units:

- (1) In terms of liquid measure for containers that are intended to be used for liquids, semisolids, viscous materials, or mixtures of solids and liquids. The expressed capacity will be stated in terms of the largest whole unit (gallon, quart, pint, fluid ounce) with any remainder in terms of common or decimal fractions of that unit.

Example:

Freezer Boxes – 4 Boxes, 946 mL capacity, 15 cm x 15 cm x 10 cm (1 qt capacity, 6 in x 6 in x 4 in)

- (2) In terms of dry measure for containers that are intended to be used for solids. The expressed capacity will be stated in terms of the largest whole unit (bushel, peck) with any remainder in terms of common or decimal fractions of that unit.

Example:

Leaf Bags – 8 Bags, 211 L capacity, 1.21 m x 1.52 m (6 bu capacity, 4 ft x 5 ft)

- (3) Where containers are used as liners for other more permanent containers, in the same terms as are normally used to express the capacity of the more permanent containers.

Example:

Garbage Can Liners – 10 Liners, 76.2 cm x 93.9 cm, fits up to 113 L cans (2 ft 6 in x 3 ft 1 in, fits up to 30 gal cans)

10.8.3. Terms. – For purposes of this section, the use of the terms “capacity,” “diameter,” and “fluid” is optional.

10.9. Textile Products, Threads, and Yarns.

10.9.1. Wearing Apparel. – Wearing apparel (including non-textile apparel and accessories such as leather goods and footwear) sold as single unit items, or if normally sold in pairs (such as hosiery, gloves, and shoes) sold as single unit pairs, shall be exempt from the requirements for net quantity statement by count, as required by Section 6.4. Terms: Weight, Liquid Measure, Dry Measure, or Count of this regulation.

10.9.2. Textiles. – Bed sheets, blankets, pillowcases, comforters, quilts, bedspreads, mattress covers and pads, afghans, throws, dresser and other furniture scarves, tablecloths and napkins, flags, curtains, drapes, dishtowels, dishcloths, towels, facecloths, utility cloths, bathmats, carpets and rugs, potholders, fixture and appliance covers, nonrectangular diapers, slipcovers, etc., shall be exempt from the requirements of Section 6.9. Bi-dimensional Commodities of this regulation, provided:

- (a) The quantity statement for fitted sheets and mattress covers shall state, in centimeters and inches, the length and width of the mattress for which the item is designed and the size designation of the mattress if the item is intended to fit a mattress identified as “twin,” “double,” “queen,” “king,” “California king,” etc.

Example:

Double sheet for 137 cm x 190 cm (54 in x 75 in) mattress.

(Amended 1987)

- (b) The quantity statement for flat sheets shall state, in centimeters and inches, the length and width of the mattress for which the sheet is designed, followed in parentheses by a statement, in centimeters and inches, of the length and width of the finished sheet. The quantity statement shall also state the size designation of the mattress for which the sheet is designed, such as “twin,” “double,” “queen,” “king,” “California king,” if the item is intended to fit such a mattress.

Example:

Twin Flat Sheet for 99 cm x 190 cm (39 in x 75 in) mattress 167 cm x 244 cm (66 in x 96 in) finished size.

(Amended 1987)

- (c) The quantity statement for pillowcases shall state, in centimeters and inches, the length and width of the pillow for which the pillowcase is designed, followed in parentheses by a statement, in centimeters and inches of the length and width of the finished pillowcase. The quantity statement for pillowcases shall also state the size designation of the pillow for which the pillowcase is designed, e.g., “youth,” “standard,” “queen,” etc., if the item is intended to fit such pillows.

Example:

Standard Pillowcase for 51 cm x 66 cm (20 in x 26 in) pillow, 51 cm x 76 cm (20 in x 30 in) in finished size.

(Amended 1977 and 1987)

- (d) The quantity statement for blankets, comforters, quilts, bedspreads, mattress pads, afghans, and throws shall state, in centimeters and inches, the length and width of the finished item. The quantity statement shall also state the length of any ornamentation and the size designation of the mattress for which the item is designed, if it is intended to fit, for example, a “twin,” “double,” “queen,” “king,” “California king,” etc., mattress.
(Amended 1988)
- (e) The quantity statement for tablecloths and napkins shall state, in centimeters and inches, the length and width of the finished item. The quantity statement also may state parenthetically, in centimeters and inches, the length and width of the item before hemming and be properly identified as such.
- (f) The quantity statement for curtains, drapes, flags, furniture scarves, etc., shall state, in centimeters and inches, the length and width of the finished item. The quantity statement also may state parenthetically, in centimeters and inches, the length of any ornamentation.
- (g) The quantity statement for carpets and rugs shall state, in meters and feet, with any remainder in decimal fractions of the meter for SI sizes or common or decimal fractions of the foot or in inches for inch-pound sizes, the length and width of the item. The quantity statement also may state parenthetically, in centimeters and inches, the length of any ornamentation.
- (h) The quantity statement for woven dishtowels, dishcloths, towels, facecloths, utility cloths, bathmats, etc., shall state, in centimeters and inches, the length and width of the item. The quantity statement for such items, when knitted, need not state the dimensions.
- (i) The quantity statement for textile products such as potholders, fixture and appliance covers, slipcovers, non-rectangular diapers, etc., shall be stated in terms of count and may include size designations and dimensions.
- (j) The quantity statement for other than rectangular textile products identified in Sections (a) through (h) shall state the geometric shape of the product and the dimensions that are customarily used in describing such geometric shape.

Examples:

Round Scarf 190 cm (74 in) in diameter;

Oval Tablecloth 177 cm x 254 cm (70 in x 100 in) representing the maximum length and width in this case.

- (k) The quantity statement for packages of remnants of textile products of assorted sizes, when sold by count, shall be accompanied by the term “irregular dimensions” and the minimum size of such remnants.

(Added 1971)

10.9.3. Sewing Threads, Handicraft Threads, and Yarns. – Sewing and handicraft threads shall be labeled as follows:

- (a) The net quantity for sewing and handicraft threads shall be expressed in terms of meters and yards.
- (b) The net quantity statement for yarns shall be expressed in terms of mass or weight.

- (c) Thread products may, in lieu of name and address, bear a trademark, symbol, brand, or other mark that positively identifies the manufacturer, packer, or distributor provided such marks are filed with the Director.
- (d) Each unit of industrial thread shall be marked to show its net length in terms of meters and yards or its net weight in terms of kilograms or grams and avoirdupois pounds or ounces, except that ready-wound bobbins that are not sold separately shall not be required to be individually marked to show the number of bobbins contained therein and the net meters and yards of thread on each bobbin.

10.10. Packaged Seed. – Packages of seeds intended for planting with net contents of less than 225 g or 8 oz shall be labeled in full accord with this regulation except as follows:

- (a) The quantity statement shall appear in the upper 30 % of the principal display panel.
- (b) The quantity statement shall be in terms of:
 - (1) the largest whole SI unit for all packages with weights up to 7 g; and
 - (2) in grams and ounces for all other packages with weights less than 225 g or 8 oz.
(Amended 1995)
- (c) The quantity statement for coated seed, encapsulated seed, pelletized seed, pre-planters, seed tapes, etc., shall be in terms of count.
(Added 1972) (Amended 1975 and 1993)

Section 11. Exemptions [NOTE 8, page 83]

NOTE 8: Section 11. Exemptions include several requirements that refer only to the historic use of inch-pound units or are direct restatements of exemptions contained in federal laws or regulations which do not include SI units. SI equivalents are omitted in most of these requirements because the SI units would not be meaningful or useful.

(Added 1993) (Amended 1995)

11.1. Random Packages. – A random package bearing a label conspicuously declaring:

- (a) the net weight;
- (b) unit price; and
- (c) the total price

shall be exempt from the SI units, type size, location, and free area requirements of this regulation. In the case of a random package packed at one place for subsequent sale at another, neither the price per unit of weight nor the total selling price need appear on the package, provided the package label includes both such prices at the time it is offered or exposed for sale at retail.

This section shall also apply to uniform weight packages of fresh fruit or vegetables labeled by count, in the same manner and by the same type of equipment as random packages exempted by this section, and cheese and cheese products labeled in the same manner and by the same type of equipment as random packages exempted by this section.

(Amended 1989)

11.1.1. Indirect Sale of Random Packages. – A random package manufactured or produced and offered for indirect sale (e.g., e-commerce, online, phone, fax, catalog, and similar methods) shall be exempt from the labeling requirements of:

- (a) unit price
- (b) total price

when the following requirements are met:

At the time of the delivery, each package need only bear a statement of net weight, provided that:

- (a) the unit price is set forth and established in the initial product offering;
- (b) the maximum possible net weight, unit price, and maximum possible price are provided to the customer by order confirmation when the product is ordered; and
- (c) when the product is delivered, the customer receives a receipt bearing the following information: identity, declared net weight, unit price, and the total price.

Indirect Sales: For the purpose of Section 11.1.1. Indirect Sale of Random Packages, indirect sales are sales where the customer makes a selection and places an order, but cannot be present when the determination of the

net quantity is made. Examples of such indirect methods include, without limitation, Internet or online sales, sales conducted by telephone or facsimile, and catalog sales.

(Added 2001) (Amended 2002)

11.2. Small Confections. – Individually wrapped pieces of “penny candy” and other confectionery of less than 15 g or ½ oz net weight per individual piece shall be exempt from the labeling requirements of this regulation when the container in which such confectionery is shipped is in conformance with the labeling requirements of this regulation. Similarly, when such confectionery items are sold in bags or boxes, such items shall be exempt from the labeling requirements of this regulation, including the required declaration of net quantity of contents, when the declaration of the bag or box meets the requirements of this regulation.

11.3. Small Packages of Meat or Meat Products. – Individually wrapped and labeled packages of meat or meat products of less than 15 g or ½ oz net weight, which are in a shipping container, need not bear a statement of the net quantity of contents when the statement of the net quantity of contents on the shipping container is in conformance with the labeling requirements of this regulation.

(Added 1987)

11.4. Individual Servings. – Individual serving size packages of foods containing less than 15 g or ½ oz or less than 15 mL or ½ fl oz for use in restaurants, institutions, and passenger carriers, and not intended for sale at retail, shall be exempt from the required declaration of net quantity of contents specified in this regulation.

11.5. Cuts, Plugs, and Twists of Tobacco and Cigars. – When individual cuts, plugs, and twists of tobacco and individual cigars are shipped or delivered in containers that conform to the labeling requirements of this regulation, such individual cuts, plugs, and twists of tobacco and cigars shall be exempt from such labeling requirements.

11.6. Reusable (Returnable) Glass Containers. – Nothing in this Regulation shall be deemed to preclude the continued use of reusable (returnable) glass containers, provided such glass containers ordered after the effective date of this regulation shall conform to all requirements of this regulation.

11.7. Cigarettes and Small Cigars. – Cartons of cigarettes and small cigars, containing ten individual packages of twenty, labeled in accordance with the requirements of this regulation shall be exempt from the requirements set

forth in Section 8.1.1. Location, Section 8.2.1. Minimum Height of Numbers and Letters, and Section 10.4. Multi-unit Packages, provided such cartons bear a declaration of the net quantity of commodity in the package.

11.8. Packaged Commodities with Labeling Requirements Specified in Federal Law. – Packages of meat and meat products, poultry products, tobacco and tobacco products, pesticides, and alcoholic beverages shall be exempt from those portions of these regulations specifying location and minimum type size of the net quantity declaration, provided quantity labeling requirements for such products are specified in federal law so as to follow reasonably sound principles of providing consumer information. (See also Section 11.32. SI Units, Exemptions - Consumer Commodities.)

11.9. Fluid Dairy Products, Ice Cream, and Similar Frozen Desserts.

- (a) When packaged in ½ liq pt and ½ gal containers, are exempt from the requirements for stating net contents of 8 fl oz and 64 fl oz, which may be expressed as ½ pt and ½ gal, respectively.
- (b) When measured by and packaged in measure containers as defined in “Measure Container Code of National Institute of Standards and Technology Handbook 44,” are exempt from the requirements of Section 8.1.1. Location that the declaration of net contents be located within the bottom 30 % of the principal display panel.
- (c) Milk and milk products when measured by and packaged in glass or plastic containers of ½ pt, 1 pt, 1 qt, ½ gal, and 1 gal capacities are exempt from the placement requirement of Section 8.1.1. Location that the declaration of net contents be located within the bottom 30 % of the principal display panel, provided other required label information is conspicuously displayed on the cap or outside closure and the required net quantity of contents declaration is conspicuously blown, formed, or molded on, or permanently applied to that part of the glass or plastic container that is at or above the shoulder of the container.
(Amended 1993)

11.10. Single Strength and Less than Single-Strength Fruit Juice Beverages, Imitations thereof, and Drinking Water.

- (a) When packaged in glass, plastic, or fluid milk type paper containers of 8 fl oz and 64 fl oz capacity, are exempt from the requirements of Section 6.2. Largest Whole Unit to the extent that net contents of 8 fl oz and 64 fl oz (or 2 qt) may be expressed as ½ pt (or half pint) and ½ gal (or half gallon), respectively.
- (b) When packaged in glass or plastic containers of ½ pt, 1 pt, 1 qt, ½ gal, and 1 gal capacities, are exempt from the placement requirements of Section 8.1.1. Location that the declaration of net contents be located within the bottom 30 % of the principal display panel, provided other label information is conspicuously displayed on the cap or outside closure and the required net quantity of contents declaration is conspicuously blown, formed, or molded into or permanently applied to that part of the glass or plastic container that is at or above the shoulder of the container.
(Amended 1993)

11.11. Soft Drink Bottles. – Bottles of soft drinks shall be exempt from the placement requirements for the declaration of:

- (a) identity when such declaration appears on the bottle closure; and
- (b) quantity when such declaration is blown, formed, or molded on or above the shoulder of the container and when all other information required by this regulation appears only on the bottle closure.

11.12. Multi-unit Soft Drink Packages. – Multi-unit packages of soft drinks are exempt from the requirement for a declaration of:

- (a) responsibility when such declaration appears on the individual units and is not obscured by the multi-unit packaging or when the outside container bears a statement to the effect that such declaration will be found on the individual units inside; and
- (b) identity when such declaration appears on the individual units and is not obscured by the multi-unit packaging.

11.13. Butter. – When packaged in 4 oz, 8 oz, and 1 lb packages with continuous label copy wrapping, butter is exempt from the requirements that the statement of identity (Section 3.1.1. Parallel Identity Declaration: Consumer Package) and the net quantity declaration (Section 8.1.5. Parallel Quantity Declaration) be generally parallel to the base of the package. When packaged in 8 oz and 1 lb units, butter is exempt from the requirement for location (Section 8.1.1. Location) of net quantity declaration.

(Amended 1980 and 1993)

11.14. Eggs. – Cartons containing 12 eggs shall be exempt from the requirement for location (Section 8.1.1. Location) of net quantity declaration. When such cartons are designed to permit division in half, each half shall be exempt from the labeling requirements of this regulation if the undivided carton conforms to all such requirements.

11.15. Flour. – Packages of wheat flour in conventional 2, 5, 10, 25, 50, and 100 lb packages shall be exempt from the requirement in this regulation for location (Section 8.1.1. Location) of the net quantity declaration.

(Amended 1980 and 1993)

11.16. Small Packages. – On a principal display panel of 32 cm² (5 in²) or less, the declaration of quantity need not appear in the bottom 30 % of the principal display panel if that declaration satisfies the other requirements of this regulation.

(Amended 1980)

11.17. Decorative Containers. – The principal display panel of a cosmetic marketed in a “boudoir-type” container, including decorative cosmetic containers of the “cartridge,” “pill box,” “compact,” or “pencil” variety, and those with a capacity of 7.4 mL (¼ oz) or less, may be a tear-away tag or tape affixed to the decorative container and bearing the mandatory label information as required by this regulation.

(Amended 1980)

11.18. Combination and Variety Packages. – Combination and variety packages are exempt from the requirements in this regulation for:

- (a) location (see Section 8.1.1. Location);
- (b) free area (see Section 8.1.4. Free Area); and
- (c) minimum height of numbers and letters (see Section 8.2.1. Minimum Height of Numbers and Letters).

(Amended 1989)

11.19. Margarine. – Margarine in 1 lb rectangular packages, except for packages containing whipped or soft margarine or packages containing more than four sticks, shall be exempt from the requirement in this regulation for location (see Section 8.1.1. Location) of the net quantity declaration.

(Amended 1980 and 1993)

11.20. Corn Flour and Corn Meal. – Corn flour and corn meal packaged in conventional 5, 10, 25, 50, and 100 lb bags shall be exempt from the requirement in this regulation for location (see Section 8.1.1. Location) of the net quantity declaration.

(Amended 1978 and 1980)

11.21. Prescription and Insulin Containing Drugs. – Prescription and insulin containing drugs subject to the provisions of Section 503(b) (1) or 506 of the Federal Food, Drug, and Cosmetic Act shall be exempt from the provisions of this regulation.

11.22. Camera Film, Video Recording Tape, Audio Recording Tape, and Other Image and Audio Recording Media Intended for Retail Sale and Consumer Use. – Image and audio media packaged and labeled for retail sale are exempt from the net quantity statement requirements of this regulation that specify how measurement of commodities should be expressed, provided:

(a) **Unexposed or Unrecorded Media.** – The net quantity of contents of unexposed or unrecorded image and audio media is expressed:

(1) For still film, tape, or other still image media, in terms of the usable or guaranteed number of available still image exposures. The length and width measurements of the individual exposures, expressed in millimeters or inches, are authorized as an optional statement.

Examples:

36 exposures, 36 mm x 24 mm, or
12 exposures, 2¼ in x 2¼ in.

(2) For bulk or movie film, in terms of length (in meters or feet) of film available for exposure.

(3) For all other image and/or audio media, in terms of length of time of electronic media available for recording, together with recording and/or playing speed or other machine settings as necessary. Supplemental information concerning the length of the media ^[NOTE 9, page 87] may be provided.

Supplemental information may be provided on other than the principal display panel.

NOTE 9: *Size, length of media, and format details to ensure interchangeability and other characteristics of audio and imaging media are available in the applicable American National Standards.*

(b) **Exposed, Recorded, or Processed Media.** – The net quantity of contents of exposed or processed film or prerecorded electronic media shall be expressed in terms of the length of time that is of entertainment value.

“Entertainment value” is defined as that portion of a film, tape, or other media that commences with the first frame of sound or picture, whichever comes first after the countdown sequence (if any), and ends with either: (a) the last frame of credits; (b) the last frame of the phrase “The End”; or (c) the end of sound, whichever is last.

(Amended 1990)

11.23. Tint Base Paint. – Tint base paint may be labeled on the principal display panel in terms of a liter, quart, or a gallon, including the addition of colorant selected by the purchaser, provided the system employed ensures that the purchaser always obtains a liter, quart, or a gallon; and further provided, in conjunction with the required quantity statement on the principal display panel, a statement indicating that the tint base paint is not to be sold without the addition of colorant is presented; and further provided the contents of the container, before the addition of colorant, is stated in fluid ounces elsewhere on the label.

Wherever the above conditions cannot be met, containers of tint base paint must be labeled with a statement of the actual net contents prior to the addition of colorant in full accord with all the requirements of this regulation.

(Added 1972) (Amended 1980 and 1993)

11.24. Motor Oil in Cans. – Motor oils when packed in cans bearing the principal display panel on the body of the container are exempt from the requirements of Section 3. Declaration of Identity: Consumer Package to the extent that the Society of Automotive Engineers (SAE) viscosity number is required to appear on the principal display

panel, provided the SAE viscosity number appears on the can lid and is expressed in letters and numerals in type size of at least 6 mm or ¼ in.

(Amended 1974, 1980, and 1993)

11.25. Pillows, Cushions, Comforters, Mattress Pads, Sleeping Bags, and Similar Products. – Those products including pillows, cushions, comforters, mattress pads, and sleeping bags, that bear a permanent label as designated by the Association of Bedding and Furniture Law Officials or by the California Bureau of Home Furnishings shall be exempt from the requirements for location (Section 8.1.1. Location), size of letters or numbers (Sections 8.2.1. Minimum Height of Numbers and Letters and 8.2.2. Numbers and Letters: Proportion), free area (Section 8.1.4. Free Area), and the declarations of identity and responsibility (Sections 3.1. Declaration of Identity and 5. Declaration of Responsibility: Consumer and Nonconsumer Packages), provided declarations of identity, quantity, and responsibility are presented on a permanently attached label and satisfy the other requirements of this Regulation, and further provided the information on such permanently attached label be fully observable to the purchaser.

(Added 1973)

11.26. Commodities' Variable Weights and Sizes. – Individual packaged commodities put up in variable weights and sizes for sale intact and intended to be weighed and marked with the correct quantity statement prior to or at the point of retail sale are exempt from the requirements of Section 6. Declaration of Quantity: Consumer Packages while moving in commerce and while held for sale prior to weighing and marking, provided the outside container bears a label declaration of the total net weight.

(Added 1973)

11.27. Packaged Commodities Sold by Count. ^[NOTE 10, page 88] – When a packaged consumer commodity is properly measured in terms of count only, or in terms of count and some other appropriate unit, and the individual units are fully visible to the purchaser, such packages shall be labeled in full accord with this Regulation, except that those containing six or less items need not include a statement of count.

(Added 1973)

NOTE 10: When the net contents declaration of a package that may enter interstate commerce includes count, federal regulations under the Federal Fair Packaging and Labeling Act provide no exemption from declaring the count unless the count is one (1).

(Added 1990)

11.28. Textile Packages. – Packages of textiles that are required by Section 6.4.1. Combination Declaration to provide a combination declaration stating the quantity of each individual unit and the count shall be exempt from the requirements in this regulation for:

- (a) Location (see Section 8.1.1. Location);
- (b) Free area (see Section 8.1.4. Free Area); and
- (c) Minimum height of numbers and letters (see Section 8.2.1. Minimum Height of Numbers and Letters).

(Added 1971) (Amended 1989)

11.29. Spot Label. – The declaration of quantity of the contents of a package is exempt from Section 8.1.1. Location requiring the quantity declaration to appear in the bottom 30 % of the principal display panel, as long as the declaration of quantity appears in the lower 30 % of the spot label. In no case may the size of the spot label be used to determine the minimum type size; see Section 8.2. Calculation of Area of Principal Display Panel for Purposes of Type Size for this determination.

(Added 1990)

11.30. Header Strip. – The declaration of quantity of the contents of a package is exempt from Section 8.1.1. Location requiring the quantity declaration to appear in the bottom 30 % of the principal display panel, as long as the declaration of quantity appears in the lower 30 % of the header strip or header label. In no case

may the size of the header strip be used to determine the minimum type size; see Section 8.2. Calculation of Area of Principal Display Panel for Purposes of Type Size for this determination.

(Added 1990)

11.31. Decorative Wallcovering Borders. – Decorative wallcovering borders when packaged and labeled for retail sale shall be exempt from the requirements of Sections 6.6.2. One Meter, 1 Square Meter, 1 Kilogram, 1 Liter, 1 Cubic Meter, or More; 6.8.2. One Foot, 1 Square Foot, 1 Pound, 1 Pint, 1 Gallon or More; and 6.9. Bi-dimensional Commodities provided the length and width of the border are presented in terms of the largest whole unit in full accord with the other requirements of the regulation.

(Added 1992) (Amended 1993)

11.32. SI Units, Exemptions - Consumer Commodities. – The requirements for statements of quantity in SI units (except for those in Section 10.10. Packaged Seed and Section 11.22. Camera Film, Video Recording Tape, Audio Recording Tape and Other Image and Audio Recording Media Intended for Retail Sale and Consumer Use) in Section 6. Declaration of Quantity: Consumer Packages shall not apply to:

- (a) foods packaged at the retail store level;
- (b) random weight packages (see Sections 2.4. Random Package and 11.1. Random Packages);
- (c) package labels printed before February 14, 1994;
- (d) meat and poultry products subject to the Federal Meat or Poultry Products Inspection Acts;
- (e) tobacco or tobacco products;
- (f) any beverage subject to the Federal Alcohol Administration Act;
- (g) any product subject to the Federal Insecticide, Fungicide, and Rodenticide Act;
- (h) drugs and cosmetics subject to the Federal Food, Drug and Cosmetic Act;
- (i) nutrition labeling information.

11.33. Inch-Pound Units, Exemptions - Consumer Commodities. – The requirements for statements of quantity in inch-pound units shall not apply to packages that bear appropriate SI units. This exemption does not apply to foods, drugs, or cosmetics or to packages subject to regulation by the FTC, meat and poultry products subject to the Federal Meat or Poultry Products Inspection Acts, and tobacco or tobacco products.

(Added 1999)

Section 12. Variations to be Allowed

12.1. Packaging Variations.

12.1.1. Variations from Declared Net Quantity. – Variations from the declared net weight, measure, or count shall be permitted when caused by unavoidable deviations in weighing, measuring, or counting the contents of individual packages that occur in current good manufacturing practice, but such variations shall not be permitted to such extent that the average of the quantities in the packages of a particular commodity or a lot of the commodity that is kept, offered, or exposed for sale, or sold is below the quantity stated, and no unreasonable shortage in any package shall be permitted even though overages in other packages in the same shipment, delivery, or lot compensate for such shortage. Variations above the declared quantity shall not be unreasonably large.

12.1.2. Variations Resulting from Exposure. – Variations from the declared weight or measure shall be permitted when caused by ordinary and customary exposure to conditions that normally occur in good

distribution practice and that unavoidably result in change of weight or measure, but only after the commodity is introduced into intrastate commerce, provided the phrase “introduced into intrastate commerce” as used in this paragraph shall be construed to define the time and the place at which the first sale and delivery of a package is made within the state, the delivery being either:

- (a) directly to the purchaser or to his/her agent; or
- (b) to a common carrier for shipment to the purchaser,

and this paragraph shall be construed as requiring that so long as a shipment, delivery, or lot of packages of a particular commodity remains in the possession or under the control of the packager or the person who introduces the package into intrastate commerce, exposure variations shall not be permitted.

12.2. Magnitude of Permitted Variations. – The magnitude of package variations of this regulation permitted under Sections 12. Variations to be Allowed, 12.1. Package Variations, 12.1.1. Variations from Declared Net Quantity, and 12.1.2. Variations Resulting from Exposure shall be those expressly set forth in this regulation and variations such as those contained in the procedures and tables of NIST Handbook 133, “Checking the Net Contents of Packaged Goods.”

(Amended 1976, 1980, 1984, and 1988)

Section 13. Retail Sale Price Representations

13.1. “Cents off” Representations.

- (a) The term “cents off representation” means any printed matter consisting of the words “cents off” or words of similar import (bonus offer, 2 for 1 sale, 1¢ sale, etc.), placed upon any consumer package or placed upon any label affixed or adjacent to such package, stating or representing by implication that it is being offered for sale at a price lower than the ordinary and customary retail sale price.

(Amended 1982)

- (b) Except as set forth in Section 13.2. Introductory Offers, the packager or labeler of a consumer commodity shall not have imprinted thereon a “cents off” representation unless:

- (1) The commodity has been sold at an ordinary and customary price in the most recent and regular course of business where the “cents off” promotion is made.
- (2) The commodity so labeled is sold at a reduction from the ordinary and customary price, which reduction is at least equal to the amount of the “cents off” representation imprinted on the commodity package or label.
- (3) Each “cents off” representation imprinted on the package or label is limited to a phrase that reflects that the price marked by the retailer represents the savings in the amount of the “cents off” the retailer’s regular price; e.g., “Price Marked is _____ Cents Off the Regular Price,” “Price Marked is ___ off the Regular Price of this Package”, provided the package or label may in addition bear in the usual pricing spot a form reflecting a space for the regular price, the represented “cents off,” and a space for the price to be paid by the consumer.
- (4) The commodity at retail presents the regular price, designated as the “regular price”, clearly and conspicuously on the package or label of the commodity or on a sign, placard, or shelf marker placed in a position contiguous to the retail display of the “cents off” marked commodity.
 - i. Not more than three “cents off” promotions of any single size commodity may be initiated in the same trade area within a 12-month period;

- ii. At least 30 days must lapse between “cents off” promotions of any particular size packaged or labeled commodity in a specific trade area; and
 - iii. Any single size commodity so labeled may not be sold in a trade area for a duration in excess of six months within any 12-month period.
- (5) Sales of any single size commodity so labeled in a trade area do not exceed in volume 50 % of the total volume of sales of such size commodity in the same trade area during any 12-month period. The 12-month period may be the calendar, fiscal, or market year provided the identical period is applied in this subparagraph and subparagraph (5) of this paragraph. Volume limits may be calculated on the basis of projections for the current year, but shall not exceed 50 % of the sales for the preceding year in the event actual sales are less than the projection for the current year.
- (c) No “cents off” promotion shall be made available in any circumstances where it is known or there is reason to know that it will be used as an instrumentality for deception or for frustration of value comparison; e.g., where the retailer charges a price that does not fully pass on to the consumers the represented price reduction or where the retailer fails to display the regular price in the display area of the “cents off” marked product.
 - (d) The sponsor of a “cents off” promotion shall prepare and maintain invoices or other records showing compliance with this section. The invoices or other records required by this section shall be open to inspection and shall be retained for a period of one year subsequent to the end of the year (calendar, fiscal, or market) in which the “cents off” promotion occurs.
- (Added 1972)

13.2. Introductory Offers.

- (a) The term “introductory offer” means any printed matter consisting of the words “introductory offer” or words of similar import, placed upon a package containing any new commodity or upon any label affixed or adjacent to such new commodity, stating or representing by implication that such new commodity is offered for retail sale at a price lower than the anticipated ordinary and customary retail sale price.
- (b) The packager or labeler of a consumer commodity may not have imprinted thereon an introductory offer unless:
 - (1) The product contained in the package is new, has been changed in a functionally significant and substantial respect, or is being introduced into a trade area for the first time.
 - (2) Each offer on a package or label is clearly and conspicuously qualified.
 - (3) No commodity so labeled is sold in a trade area for duration in excess of six months.
 - (4) At the time of making the introductory offer promotion, the offerer intends in good faith to offer the commodity, alone, at the anticipated ordinary and customary price for a reasonably substantial period of time following the duration of the introductory offer promotion.
- (c) The packager or labeler of a consumer commodity shall not have imprinted thereon an introductory offer in the form of a “cents off” representation unless, in addition to the requirements in paragraph (b) of this section:
 - (1) The package or label clearly and conspicuously and in immediate conjunction with the phrase “Introductory Offer” bears the phrase “_____ cents off the after introductory offer price.”

- (2) The commodity so labeled is sold at a reduction from the anticipated ordinary customary price, which reduction is at least equal to the amount of the reduction from the after introductory offer price representation on the commodity package or label.
- (d) No introductory offer with a “cents off” representation shall be made available in any circumstance where it is known or there is reason to know that it will be used as an instrumentality for deception or for frustration of value comparison; e.g., where the retailer charges a price that does not fully pass on to consumers the represented price reduction.
- (e) The sponsor of an introductory offer shall prepare and maintain invoices or other records showing compliance with this section. The invoices or other records required by this section shall be open to inspection and shall be retained for a period of one year subsequent to the period of the introductory offer.
(Added 1972)

13.3. Economy Size.

- (a) The term “economy size” means any printed matter consisting of the words “economy size,” “economy pack,” “budget pack,” “bargain size,” “value size,” or words of similar import placed upon any package containing any consumer commodity or placed upon any label affixed or adjacent to such commodity, stating or representing directly or by implication that a retail sale price advantage is accorded the purchaser thereof by reason of the size of that package or the quantity of its contents.
- (b) The packager or labeler of a consumer commodity may not have imprinted thereon an “economy” size representation unless:
 - (1) At the same time the same brand of the commodity is offered in at least one other packaged size or labeled form.
 - (2) Only one packaged or labeled form of that brand of commodity labeled with an “economy size” representation is offered.
 - (3) The commodity labeled with an “economy size” representation is sold at a price per unit of weight, volume, measure, or count that is substantially reduced (i.e., at least 5 %) from the actual price of all other packaged or labeled units of the same brand of that commodity offered simultaneously.
- (c) No “economy size” package shall be made available in any circumstances where it is known that it will be used as an instrumentality for deception; e.g., where the retailer charges a price that does not pass on to the consumer the substantial reduction in cost per unit initially granted.
- (d) The sponsor of an “economy size” package shall prepare and maintain invoices or other records showing compliance with paragraph (b) of this section. The invoices or other records required by this section shall be open to inspection and shall be retained for one year.
(Added 1972)

Section 14. Revocation of Conflicting Regulations

All provisions of all orders and regulations heretofore issued on this same subject that are contrary to or inconsistent with the provisions of this regulation and specifically _____ are hereby revoked.

Section 15. Effective Date

This regulation shall become effective on August 1, ~~2013~~2014.

UPLR Appendix A: SI/Inch-pound Conversion Factors **

| LENGTH | | | |
|--|----------------------------|---|------------------------------|
| 1 mil (0.001 in) = | 25.4 μm^* | 1 micrometer = | 0.039 370 mil |
| 1 inch = | 2.54 cm* | 1 millimeter = | 0.039 370 1 in |
| 1 foot = | 30.48 cm* | 1 centimeter = | 0.393 701 in |
| 1 yard = | 0.914 4 m* | 1 meter = | 3.280 84 ft |
| 1 rod = | 5.029 2 m* | | |
| AREA | | | |
| 1 square inch = | 6.451 6 cm ² * | 1 square centimeter = | 0.155 000 in ² |
| 1 square foot = | 929.030 cm ² | 1 square decimeter = | 0.107 639 ft ² |
| 1 square yard = | 0.836 127 m ² | 1 square meter = | 10.763 9 ft ² |
| VOLUME or CAPACITY | | | |
| 1 cubic inch = | 16.387 1 cm ³ | 1 cubic centimeter = | 0.061 023 74 in ³ |
| 1 cubic foot = | 0.028 316 8 m ³ | 1 cubic decimeter = | 0.035 314 7 ft ³ |
| | 28.316 8 L | 1 cubic meter = | 35.314 7 ft ³ |
| 1 cubic yard = | 0.764 555 m ³ | | 1.307 95 yd ³ |
| 1 fluid ounce = | 29.573 5 mL | 1 milliliter (cm ³) = | 0.033 814 fl oz |
| 1 liquid pint = | 473.177 mL | 1 liter = | 1.056 69 liq qt |
| | 0.473 177 L | | 0.264 172 gal |
| 1 liquid quart = | 946.353 mL | 1 dry pint = | 550.610 5 mL |
| | 0.946 353 L | 1 dry quart = | 1.101 221 L |
| 1 gallon = | 3.785 41 L | 1 peck = | 8.809 768 L |
| 1 bushel = | 35.239 1 L | 1 gill = | 118.294 1 mL |
| MASS (weight) | | | |
| 1 ounce = | 28.349 5 g | 1 milligram = | 0.000 035 274 oz |
| 1 pound = | 453.592 37 g* | | 0.015 432 4 grain |
| | 0.453 592 kg | 1 gram = | 0.035 274 oz |
| 1 grain = | 64.798 91 mg | 1 kilogram = | 2.204 62 lb |
| TEMPERATURE | | | |
| $t_{\circ F} = 1.8 t_{\circ C} + 32^*$ | | $t_{\circ C} = \frac{5}{9}(t_{\circ F} - 32)^*$ | |
| <p>* Exactly ** These conversion factors are given to six or more significant digits in the event such accuracy is necessary. To convert to inch-pound units divide the factor rather than multiplying. (Amended 1998)</p> | | | |

THIS PAGE LEFT INTENTIONALLY BLANK

MARKUP COPY

UPLR Appendix B: Converting Inch-pound Units to SI Units
for Quantity Declarations on Packages

1. Conversion.

To convert an inch-pound quantity to an SI quantity, multiply the appropriate conversion factor in Table 1 in Appendix A by the inch-pound unit and round according to the following rules.

2. Rounding and Significant Digits.

It is the packager's responsibility to round converted values appropriately and select the appropriate number of significant digits to use in quantity declaration. [These rounding rules are for converting quantity determinations on packages and do not apply to digital scales that automatically round indications to the nearest indicated value.] Conversions, the proper use of significant digits, and rounding must be based on the packer's knowledge of the accuracy of the original measurement that is being converted. For example, if a package is labeled 453.59 g (1 lb), the packer is implying that the package declaration is accurate within ± 0.005 g (or ± 5 mg). For liquid volume measure, a label declaration of 473 mL (16 fl oz) implies that the package declaration is accurate to within ± 0.5 mL (0.01 fl oz). The requirements of 6.13. Rounding apply to all quantity declarations that are derived from converted values:

6.13. Rounding. – In all conversions for the purpose of showing an equivalent SI or inch-pound quantity to a rounded inch-pound or SI quantity, or in calculated values to be declared in the net quantity statement, the number of significant digits retained must be such that accuracy is neither sacrificed nor exaggerated. Conversions, the proper use of significant digits, and rounding must be based on the packer's knowledge of the accuracy of the original measurement that is being converted. In no case shall rounded net contents declarations overstate a quantity; the packer may round converted values down to avoid overstating the net contents.

NOTE: When as a result of rounding SI or customary inch-pound declarations calculated based on the conversion factors in Appendix A, the resulting declarations are not exact, the largest declaration, whether metric or inch-pound, will be used for enforcement purposes to determine whether a package contains at least the declared amount of the product.

Do not round conversion factors or any other quantity used or determined in the calculation; only round the final quantity to the number of significant digits needed to maintain the accuracy of the original quantity. Use the rounding rules presented below in Table 1 as guidance to round the final result. In general, quantity declarations on consumer commodities should only be shown to two or three significant digits (for example, 453 g or 85 g). Any final zeros to the right of the decimal point need not be expressed. The inch-pound and SI declarations of quantity must be accurate and equivalent to each other. For example, a package bearing a net weight declaration of 2 lb (32 oz) must also include an SI declaration of 907 g.

| <u>Table 1. Rounding Rules</u> | | |
|--|--|--|
| <u>When The First Digit Dropped is:</u> | <u>The Last Digit Retained is:</u> | <u>Examples</u> |
| <u>less than 5</u> | <u>Unchanged</u> | <u>2.44 to 2.4</u> <u>2.429 to 2.4</u> |
| <u>more than 5, or 5 followed by at least 1 digit other than 0</u> | <u>Increased by 1</u> | <u>2.46 to 2.5</u> <u>2.451 to 2.5</u> |
| <u>5 followed by zeros</u> | <u>Unchanged if Even, or Increased by 1 if Odd</u> | <u>2.450 to 2.4</u> <u>2.550 to 2.6</u> |

- (a) When the first digit discarded is less than 5, the last digit retained should not be changed. For example, if the quantity 984.3 is to be declared to 3 significant digits, the number 3 to the right of the decimal point must be discarded since it is less than 5 and the last digit to be retained (the number 4) will remain unchanged. The rounded number will read 984. The same rationale applies to numbers declared to two significant digits (for example 68.4 and 7.34); again, the final digit is dropped and the last digit retained remains unchanged so that the “rounded-off” numbers become 68 and 7.3 respectively.
- (b) When the first digit to be discarded is greater than 5, or it is a 5 followed by at least one digit other than zero, the last digit to be retained should be increased by one unit.

Examples:

984.7 becomes 985
984.51 becomes 985
6.86 becomes 6.9
6.88 becomes 6.9

- (c) When the first digit to be discarded is exactly 5, followed only by zeros, the final digit to be retained should be rounded up if it is an odd number (1, 3, 5, 7, or 9), but no adjustment should be made if it is an even number (2, 4, 6, or 8).

Examples:

984.50 becomes 984
985.50 becomes 986
68.50 becomes 68
7.450 becomes 7.4
7.550 becomes 7.6

**NOTE: See additional examples in Table 2.*

3. Additional Advice on Rounding and Significant Digits

- (a) These rules require the packer to use good judgment in making decisions on how to round and the number of significant digits to use in quantity declarations. Rounding should always be done in one step; for example, if 16.946 47 g has to be rounded to three significant digits, it should be rounded to 16.9 g, not 16.946 5, then to 16.946, then to 16.95 which would then round to 17.0 g (see rounding rules above).

- (b) Do not use rounded SI values to calculate quantities. For example, using 1 in = 25.4 mm, rounded to 25 mm, should not be multiplied by 2 to determine the SI equivalent for 2 in. The SI equivalent for 2 in is determined by multiplying 2 in x 25.4 mm = 50.8 mm, then rounding to 51 mm.
- (c) If a dimension given as 8 ft is valid to the nearest $\frac{1}{10}$ in, consider it to mean 96.0 in and treat it as having 3 significant digits. The rounded dimension would then be 2.44 m instead of 2.4 m.
- (d) Conversions using a multiple digit conversion factor usually give a product with more digits than the original quantity. The final product should contain no more significant digits than are contained in the number with the fewest significant digits used in the conversion. For example, the area of a sheet of paper is determined on a calculator by multiplying 1.25 cm (length) x 1.5 cm (width) = 1.875 cm². The product given to 4 significant digits on the calculator cannot be any more accurate than two significant digits (the number of significant digits in 1.5 cm), so the area should be declared as 1.9 cm².
- (e) Packagers of consumer commodities should be aware that when a converted value is rounded up, there may be a need to (1) increase the package contents and/or, (2) select a converted value that does not exaggerate the precision of the quantity or overstate the net contents. For example, under the rules above, a net weight declaration of 16 oz (453.592 37 g) may be rounded up to 454 g for three significant digits. Inspections by weights and measures officials are typically conducted using devices with a resolution of 0.5 g or less. If the packer does not address this possibility, some lots of commodities may pass when the inch-pound declaration is tested, but fail when the SI declaration is verified.

Table 2. Examples

| Weight: | | |
|--|----------------------|---------------------|
| To convert ounces to grams, multiply ounces by 28.349 5 grams | | |
| Inch-pound | Calculated SI | Rounded SI |
| 1.0 oz | 28.349 5 g | 28 g |
| 5.0 oz | 141.747 6 g | 142 g |
| 10¼ oz | 290.582 38 g | 291 g* |
| 16.0 oz | 453.592 4 g | 454 g* |
| 32.0 oz | 907.184 g | 907 g |
| 48.0 oz | 1360.776 g | 1.36 kg |
| 5 lb | 2.267 962 kg | 2.27 kg* |
| 10 lb | 4.535 924 kg | 4.54 kg* |
| 25 lb | 11.339 81 kg | 11.3 kg |
| Liquid Volume: | | |
| to convert fluid ounces to millimeters, multiply fluid ounces by 29.573 5 milliliters | | |
| Inch-pound | Calculated SI | Rounded SI |
| 1.0 fl oz | 29.573 5 mL | 30 mL* |
| 8.0 fl oz | 236.588 mL | 237 mL* |
| 16.0 fl oz | 473.176 mL | 473 mL |
| 32.0 fl oz | 946.353 mL | 946 mL |
| 1 gal | 3.785 41 L | 3.79 L* |
| 2½ gal | 9.463 525 L | 9.46 L |
| 5 gal | 18.927 05 L | 18.9 L |
| Dry Measure: | | |
| to convert dry pints to milliliters, multiply dry pints by 550.610 5 milliliters | | |
| Inch-pound | Calculated SI | Rounded SI |
| 1 dry pt | 550.610 5 mL | 551 mL* |
| 1 dry qt | 1.101 221 L | 1.1 L |
| Length: | | |
| to convert inches to millimeters, multiply inches by 25.4 millimeters | | |
| Inch-pound | Calculated SI | Rounded SI |
| 10.5 in | 266.7 mm | 267 mm* or 26.7 cm* |
| 1 ft | 30.48 cm | 305 mm* or 30.5 cm* |
| 5 ft | 152.4 cm | 152 cm or 1.5 m |
| 50 ft | 15.240 03 m | 15.2 m |
| 100 ft | 30.480 06 m | 30.5 m* |
| * See 6.13. Rounding located under UPLR Appendix B | | |

B. Uniform Regulation for the Method of Sale of Commodities

as adopted by
The National Conference on Weights and Measures*

1. Background

The National Conference on Weights and Measures (NCWM) has long been concerned with the proper units of measurement to be used in the sale of all commodities. This approach has gradually broadened to concerns of standardized package sizes and general identity of particular commodities. Requirements for individual products were at one time made a part of the Weights and Measures Law or were embodied in separate individual Model Regulations. In 1971, this “Model State Method of Sale of Commodities Regulation” was established (renamed in 1983); amendments have been adopted by the Conference almost annually since that time.

Sections with “added 1971” dates refer to those sections that were originally incorporated in the Weights and Measures Law or in individual Model Regulations recommended by the NCWM. Subsequent dates reflect the actual amendment or addition dates.

The 1979 edition included, for the first time, requirements for items packaged in quantities of the International System of Units (SI), the modernized metric system, as well as continuing to present requirements for inch-pound quantities. It should be stressed that nothing in this Regulation requires changing to the SI system of measurement. SI values are given for the guidance of those wishing to adopt new SI quantities of the commodities governed by this Regulation. SI means the International System of Units as established in 1960 by the General Conference on Weights and Measures and interpreted or modified for the United States by the Secretary of Commerce.

This Regulation assimilates all of the actions periodically taken by the Conference with respect to certain food items, non-food items, and general method of sale concepts. Its format is such that it will permit the addition of individual items at the end of appropriate sections as the need arises. Its adoption as a regulation by individual jurisdictions will eliminate the necessity for legislative consideration of changes in the method of sale of particular commodities. Such items will be able to be handled through the normal regulation-making process.

2. Status of Promulgation

The table beginning on page 10 shows the status of adoption of the Uniform Regulation for the Method of Sale of Commodities.

**The National Conference on Weights and Measures (NCWM) is supported by the National Institute of Standards and Technology (NIST) in partial implementation of its statutory responsibility for “cooperation with the states in securing uniformity in weights and measures laws and methods of inspection.”*

THIS PAGE INTENTIONALLY LEFT BLANK

MARKUP COPY

Uniform Regulation for the Method of Sale of Commodities

Preamble

The purpose of this regulation is to require accurate and adequate information about commodities so that purchasers can make price and quantity comparisons.

(Added 1989)

Section 1. Food Products ^[NOTE 1, page 109]

1.1. Berries and Small Fruits

1.1.1. Definitions. – “Small fruits” includes, but is not limited to, cherries, currants, and cherry tomatoes. “Berries” includes all fruit whose names end in the term “berry.”

(Added 1991)

NOTE 1: Packages subject to this Section and the Federal Fair Packaging and Labeling Act shall be labeled in units of the International System of Units (SI) and inch-pound systems of measure effective February 14, 1994, [except for seed (see Section 10.10. Packaged Seed) and camera film and recording tape (see Section 11.22. Camera Film, Video Recording Tape, Audio Recording Tape, and Other Image and Audio Recording Media Intended for Retail Sale and Consumer Use), and as specified in the Uniform Packaging and Labeling Regulation under Section 11.32. SI Units, Exemptions - Consumer Commodities]. SI units may appear first.

(Added 1982) (Amended 1990 and 1993)

1.1.2. Methods of Sale. – Berries and small fruits shall be offered and exposed for sale and sold by weight ^[NOTE 2, page 109] or by volume. If sold by volume, they must:

(Amended 1991)

- (a) be in measure containers that are either open or else covered by uncolored transparent lids or other wrappings that do not obscure the contents, and
- (b) have capacities per Section 1.1.2.(b)(1) or Section 1.1.2.(b)(2). When selling berries and small fruits by volume in measure containers, whether or not covered, the measure containers themselves shall not be packages for labeling purposes.
 - (1) SI Capacities – 250 milliliters, 500 milliliters, or 1 liter.
(Added 1979) (Amended 1985)
 - (2) Inch-pound Capacities – ½ dry pint, 1 dry pint, or 1 dry quart.

NOTE 2: When used in this regulation, the term “weight” means “mass.” (See paragraphs U. “Mass” and “Weight” in Section I. Introduction of NIST Handbook 130 for an explanation of these terms.)

1.1.3. Marking Requirements for Shipping Containers. – If two or more measure containers are placed in a shipping package, the crate or package shall show the number of measure containers and the quantity of contents of each.

(Added 1971) (Amended 1979, 1985, 1989, and 1991)

1.2. Bread. – Bread kept, offered, or exposed for sale, whether or not packaged or sliced, shall be sold by weight. The wrappers of bread that is sold and expressly represented at the time of sale as “stale bread” shall not be considered packages for labeling purposes.

(Added 1971) (Amended 1979, 1980, 1985, 1987, 1991, and 1992)

1.3. Butter, Oleomargarine, Margarine, Butter-Like, and/or Margarine-Like Spreads. – Shall be offered and exposed for sale and sold by weight. “Butter-like and/or margarine-like spreads” are those products that meet the Federal Standard of Identity for butter or margarine and oleomargarine, except that they contain less than 80 % fat and may contain other safe and suitable ingredients.

(Added 1971) (Amended 1979, 1985, 1986, and 1994)

1.4. Flour, Corn Meal, and Hominy Grits. – Wheat flour, whole wheat flour, graham flour, self-rising wheat flour, phosphated wheat flour, bromated flour, corn flour, corn meal, and hominy grits, whether enriched or not, shall be packaged, kept, offered, or exposed for sale and sold by weight.

(Amended 1994)

1.5. Meat, Poultry, Fish, and Seafood. ^[NOTE 3, page 110] – Shall be sold by weight, except that whole shellfish in the shell may be sold by weight, measure, and/or count. Shellfish are aquatic animals having a shell, such as mollusks (for example, scallops) or crustaceans (for example, lobster or shrimp).

(Amended 1988)

NOTE 3: See Section 1.12. Ready-to-Eat Food for additional requirement.

1.5.1. In Combination with Other Foods. – When meat, poultry, fish, or seafood is combined with some other food element to form a distinctive food product, the quantity representation may be in terms of the total weight of the product or combination, and a quantity representation need not be made for each element provided a statement listing the ingredients in order of their predominance by weight must also appear on the label.

Note: See Interpretations and Guidelines Section 2.2.13. Declaration of Identity: Consumer Package and Labeling Regulation (UPLR).

(Amended 1989)

1.5.2. Clams, Mussels, Oysters, and Other Mollusks.

1.5.2.1. Whole Clams, Oysters, Mussels, or Other Mollusks in the Shell (fresh or frozen). – Shall be sold by weight (including the weight of the shell, but not including the liquid or ice packed with them), dry measure (e.g., bushel), and/or count. In addition, size designations may be provided.

1.5.2.2. Whole Clams, Oysters, Mussels, or Other Mollusks on the Half Shell (fresh, cooked, smoked, or frozen, with or without sauces or spices added). – Shall be sold by weight (excluding the weight of the shell) or by count. Size designations may also be provided.

(Added 1989)

1.5.2.3. Fresh Oysters Removed from the Shell. – Shall be sold by weight, drained weight, or by fluid volume. For oysters sold by weight or by volume, a maximum of 15 % free liquid by weight is permitted.

(Amended 1991)

1.5.2.4. Processed Clams, Mussels, Oysters, or Other Mollusks on the Half Shell (fresh or frozen). – Shall be sold by net weight excluding the weight of the shell. The term “processed” means removing the meat from the shell and chopping it or cutting it or commingling it with other solid foods.

(Amended 1989)

1.5.2.5. Canned (heat-processed) Mussels, Clams, Oysters, or Other Mollusks. – Shall be sold by net weight. A maximum of 41 % free liquid by weight is permitted for canned oysters.

(Added 1986 and 1971) (Amended 1982, 1985, 1986, and 1989)

1.6. Fluid Milk Products. – All fluid milk products, including, but not limited to milk, lowfat milk, skim milk, cultured milks, and cream, shall be sold in terms of fluid volume.

(Amended 1995)

1.7. Other Milk Products. – Cottage cheese, cottage cheese products, and other milk products that are solid, semi-solid, viscous, or a mixture of solid and liquid, as defined in the Pasteurized Milk Ordinance of the U.S. Public Health Service, as amended in 1965, shall be sold in terms of weight.

(Amended 1995)

1.7.1. Factory Packaged Ice Cream and Similar Frozen Products. – Ice cream, ice milk, frozen yogurt, and similar products shall be kept, offered, or exposed for sale or sold in terms of fluid volume.

(Amended 1995)

1.7.2. Pelletized Ice Cream and Similar Pelletized Frozen Desserts. – A semi-solid food product manufactured at very low temperatures using a nitrogen process and consisting of small beads of varying sizes. Bits of inclusions (cookies, candy, etc.) that also vary in size and weight may be mixed with the pellets.

1.7.2.1. Method of Retail Sale. – Packaged pelletized ice cream or similar pelletized frozen desserts shall be kept, offered, or exposed for sale on the basis of net weight.

Note: This method of sale for pelletized ice cream shall be enforceable after April 17, 2010, and after August 2, 2011, for similar pelletized frozen desserts.

(Added 2010) (Amended 2011)

1.8. Pickles. – The declaration of net quantity of contents on pickles and pickle products, including relishes but excluding one or two whole pickles in a transparent wrapping, which may be declared by count, shall be expressed in terms of liquid measure. Sales of pickles from bulk may be by count.

(Added 1971)

1.9. Advertising and Price Computing of Bulk Food Commodities.

1.9.1. Total Price Computing. – The price of food commodities sold from bulk by weight shall be computed in terms of whole units of weight (i.e., grams, kilograms, pounds, ounces, etc.) and not in common or decimal fractions.

1.9.2. Unit Price Advertising. – The price of food commodities sold from bulk by weight shall be advertised or displayed in terms of whole weight units of kilograms or pounds only, not in common or decimal fractions or in ounces. A supplemental declaration is permitted in print no larger than the whole unit price. This supplemental declaration may be expressed in common or decimal fractions or in ounces.

(Added 1976) (Amended 1985, 1987, and 1991)

1.10. Generic Terms for Meat Cuts. – A declaration of identity for meat cuts shall be limited to generic terms, such as those listed in the Uniform Retail Meat Identity Standards.

The following abbreviations may be used:

| | | | |
|-----------|----------|---------|-----------|
| BAR B Q | Barbecue | POT-RST | Pot Roast |
| BI | Bone In | RND | Round |
| BNLS | Boneless | RST | Roast |
| DBLE | Double | SHLDR | Shoulder |
| LGE | Large | SQ | Square |
| N.Y. (NY) | New York | STK | Steak |
| PK | Pork | TRMD | Trimmed |

(Added 1976)

1.11. Sale of Meat by Carcass, Side, or Primal Cut. – The seller of a carcass, side, quarter, or primal cut on a gross or hanging weight basis shall provide to the buyer a written statement giving the following information at the times indicated:

(Amended 1985)

1.11.1. Prior to Delivery.

- (a) the name and address of the seller (firm);
- (b) the date of the contract;
- (c) the name and address of the buyer;
- (b) the total net weight (hanging weight) of the carcass, side, or primal cut prior to cutting or processing;
- (e) the USDA quality grade and yield grade of the meat to be supplied, if so represented;
- (f) the price per pound for each species (not including any inducements) and the total price of the sale order;
- (g) the estimated cutting loss on the order in terms of percentage and weight (e.g., 40 %, 72.5 kg [160 lb]);
- (h) a list by name and estimated count of each cut to be derived from each primal source;
- (i) additional costs, listed separately, for cutting, wrapping, freezing, and finance charges, if any; and
- (j) that the buyer may keep the cutting loss.

(Added 1985)

1.11.2. At the Time of Delivery.

- (a) the name and address of the buyer and seller;
- (b) the date of delivery;
- (c) the total net weight of the meat delivered;
- (d) a list, by name and count, of each cut derived from each primal cut; and
- (e) a separate indication of the quantity of any meat or other commodity(s) received by the purchaser as an inducement in connection with the purchase of the carcass, side, or primal cut.

(Added 1985)

1.11.3. Exemptions. – This subsection shall not apply to the sale of any carcass, side, quarter, or primal cut of meat that individually or collectively has a gross or hanging weight of 22.6 kg (50 lb) or less.

(Added 1985)

1.11.4. Right of Cancellation. – The buyer shall have the right to cancel any carcass, side, quarter, or primal cut meat contract until midnight of the third business day after the day on which the buyer executed the contract or after the day on which the seller provided the buyer with a fully executed copy of the contract, whichever is later.

(Added 1985 and 1977) (Amended 1980 and 1985)

1.12. Ready-to-Eat Food.

1.12.1. Definition - Ready-to-Eat Food. – Restaurant style food offered or exposed for sale, whether in restaurants, supermarkets, or similar food service establishments, that is ready for consumption, though not necessarily on the premises where sold. Ready-to-Eat Food does not include sliced luncheon products, such as meat, poultry, or cheese when sold separately.

NOTE: The sale of an individual piece of fresh fruit (like an apple, banana, or orange) is allowed by count.
(Added 2004)

1.12.2. Methods of Sale. – Ready-to-Eat Food sold from bulk or in single servings packed on the premises may be sold by weight, measure, or count (count includes servings).

(Amended 1993)

1.13. Home Food Service Plan Sales.

1.13.1. Definitions.

As used in this section, the following words and phrases shall have the following meanings:

- (a) **Home Food Service Plan.** – The offering for sale to a consumer, in the consumer’s home, any food item, or food item in combination with any nonfood item and/or services, whether or not a membership fee or similar charge is involved.
- (b) **Seller.** – Any person, partnership, corporation, or association, however organized, engaged in the sale of a home food service plan.
- (c) **Buyer.** – Both the actual and prospective purchaser, but does not include persons purchasing for resale.
- (d) **Contract.** – All of the collective written agreements subscribed by a buyer at the time of sale relating to the purchase of a home food service plan, except promissory notes or other financing agreements.
- (e) **Food Item.** – Each edible product sold as part of a home food service plan, including, but not limited to, each constituent part or kind of meat cut from a primal source, each kind of whole poultry or poultry part, seafood products, and other like products.
- (f) **Nonfood Item.** – Each inedible product sold as part of a home food service plan, including, but not limited to, paper products, health and beauty products, detergents, cleaners and disinfectants, rolls of wrapping, and like products. The term does not include food items and durable consumer goods such as appliances.
- (g) **Unit Price.** – The price of a food or nonfood item sold as part of a home food service plan, computed to the nearest tenth of 1 cent when less than 1 dollar, and to the nearest cent when 1 dollar or more. The unit price, exclusive of any service charge(s), shall be expressed in terms of the price per unit of weight, measure, or count set forth in the “Uniform Unit Pricing Regulation” in the current edition of NIST Handbook 130.
- (h) **Service Charge.** – The total price for any additional features, services, and processing associated with the purchase of a home food service plan, whether stated in terms of membership fees or otherwise.
- (i) **Primal Source.** – Refers to the following cuts:
 - (1) for beef, the primal sources are the round, flank, loin, rib, plate, brisket, chuck, and shank;

- (2) for veal and lamb or mutton, the primal sources are the leg, flank, loin, rack (rib), and shoulder; and
- (3) for pork, the primal sources are the belly, loin, ham, spareribs, shoulder, and jowl.

1.13.2. Contract and Disclosure Requirements.

1.13.2.1. At the Time of Sale:

- (a) At the time of sale, the Seller shall provide the Buyer with a single document, referred to in this subsection as the “written agreement,” which shall clearly and conspicuously disclose the following:
 - (1) the name, address, and telephone number of the Seller and the name and address of the Buyer;
 - (2) the date of the contract;
 - (3) the price of the food and nonfood items of the home food service plan;
 - (4) the service charge or the price of any service charges associated with the home food service plan;
 - (5) the total price of the home food service plan, including the price of the food and nonfood items, and the price of any service charge; and
 - (6) a statement that the Buyer shall have the right to cancel the home food service plan contract until midnight of the third business day after the date on which the Buyer executed the contract or after the day on which the Seller provided the Buyer with a fully executed copy of the contract, whichever is later, by giving written notice of cancellation to the Seller. Compliance with requirements of federal statutes, rules, or regulations governing form of notice of right of cancellation shall be deemed satisfactory notice of the requirements of this regulation.
- (b) In addition to the above disclosures required in the written agreement, the following disclosures are required to be given to the Buyer at the time of sale:
 - (1) A written list of all food and nonfood items to be sold, which shall include:
 - i. the identity of each unit and, where applicable, the USDA quality grade of the item, if so graded; the primal source; and the brand or trade name;
 - ii. the quantity of each item sold;
 - iii. the estimated serving size by net weight of each piece of meat, poultry, and seafood item offered for sale under the home food service plan, provided, however, that such estimates shall not differ from the actual weight at the time of delivery by more than 5 % and the dollar value of the meat, poultry, and seafood items delivered is equal to or greater than that represented to the Buyer; and
 - iv. the net weight, measure, or count of all other food and nonfood items offered for sale.
 - (2) A current unit price list stating in dollars and cents the price per kilogram or pound or other appropriate unit of measure, and the total sale price of each item to be delivered. This price list shall clearly and conspicuously make reference to the fact of whether there are additional costs disclosed in the written agreement relating to any “service charges” associated with the purchase of the home food service plan.
 - (3) If a membership is sold, a written statement of all terms, conditions, benefits, and privileges applicable to the membership.

- (4) If a service charge is included, a written statement specifically identifying the service(s) provided and the price(s) charged for them.

1.13.2.2. At the Time of Delivery:

- (a) At the time of delivery, the Seller shall provide a receipt, for signature by the Buyer, disclosing the following information:
- (1) the identity of the item and the net quantity of the contents in terms of either weight, measure, or count, as required by applicable law. The net weight of each food item delivered shall be within the limit specified in Section 1.13.2.1.b(i)(iii) Contract and Disclosure Requirements; and
 - (2) the unit price and total sales price of each food and nonfood item. The unit price shall be the same as that specified on the unit price list given to the Buyer at the time of sale.

1.13.3. Advertisement of Home Food Service Plans. – Any advertisement of a home food service plan which discloses item pricing information in accordance with the provisions of this section shall set forth, in a clear and conspicuous manner, whether there are any service charges or other additional costs associated with the purchase of the home food service plan.

(Added 1992)

Section 2. Non-food Products ^[NOTE 1, page 109]

2.1. Advertising and Price Computing of Bulk Commodities. – The price of bulk commodities or commodities not in package form and sold by weight shall be advertised, displayed, and computed in terms of whole units of weight (i.e., grams, kilograms, pounds, ounces, etc.), and not in common or decimal fractions.

(Added 1989)

2.2. Fence Wire Products. – Rolls of fence wire products shall be sold by:

- (a) Gauge of wire.
- (b) Height in terms of inches or centimeters, if applicable.
- (c) Length in terms of rods, meters, or feet.

(Added 1979)

2.3. Coatings. – Asphalt paints, coatings, and plastics shall be sold in terms of liquid measure.

(Added 1971)

2.4. Fireplace and Stove Wood. – For the purpose of this regulation, this section shall apply to the sale of all wood, natural and processed, for use as fuel or flavoring.

(Amended 1999)

2.4.1. Definitions.

2.4.1.1. Fireplace and Stove Wood. – Any kindling, logs, boards, timbers, or other wood, natural or processed, split or not split, advertised, offered for sale, or sold for use as fuel.

(Amended 1991)

2.4.1.2. Cord. – The amount of wood that is contained in a space of 128 ft³ when the wood is ranked and well stowed. For the purpose of this regulation, “ranked and well stowed” shall be construed to mean that

pieces of wood are placed in a line or row, with individual pieces touching and parallel to each other, and stacked in a compact manner.

2.4.1.3. Representation. – This shall be construed to mean any advertisement, offering, invoice, or the like that pertains to the sale of fireplace or stove wood.

2.4.1.4. Flavoring Chips. – Any kindling, logs, boards, timbers, or other natural or processed, split or unsplit wood that is advertised, offered for sale, or sold for flavoring smoked or barbecued foods.

(Added 1999)

2.4.2. Identity. – A representation may include a declaration of identity that indicates the species group (for example, 50 % hickory, 50 % miscellaneous softwood). Such a representation shall indicate, within 10 % accuracy, the percentages of each group.

2.4.3. Quantity. – Fireplace and stove wood shall be advertised, offered for sale, and sold only by measure, using the term “cord” and fractional parts of a cord or the cubic meter, except that:

(a) **Packaged natural wood.** – Natural wood offered for sale in packaged form in quantities less than 0.45 m^3 ($\frac{1}{8}$ cord or 16 ft^3) shall display the quantity in terms of:

- (1) liters, to include fractions of liters; or
- (2) cubic inches, if less than one cubic foot; or
- (3) cubic feet, if one cubic foot or greater, to include fractions of a cubic foot.

(Amended 2010)

(b) **Artificial compressed or processed logs.** – A single fireplace log shall be sold by weight, and packages of such individual logs shall be sold by weight plus count.

(c) **Stove wood pellets or chips.** – Pellets or chips not greater than 15 cm (6 in) in any dimension shall be sold by weight. This requirement does not apply to flavoring chips.

(Amended 1976 and 1991)

(d) **Flavoring chips.** – Flavoring chips offered for sale in packaged form in quantities less than 0.45 m^3 ($\frac{1}{8}$ cord or 16 ft^3) shall display the quantity in terms of:

- (1) liters, to include fractions of liters; or
- (2) cubic inches, if less than one cubic foot; or
- (3) cubic feet, if one cubic foot or greater, to include fractions of a cubic foot.

(Added 1998)(Amended 2010)

Note: In determining the appropriate Method of Sale, a clear distinction must be made as to whether the wood is being sold primarily as fuel (some wood is sold as fuel but flavoring is a byproduct) or strictly as a wood flavoring.

(Added 2010)

2.4.4. Prohibition of Terms. – The terms “face cord,” “rack,” “pile,” “truckload,” or terms of similar import shall not be used when advertising, offering for sale, or selling wood for use as fuel.

2.4.5. Delivery Ticket or Sales Invoice. – A delivery ticket or sales invoice shall be presented by the seller to the purchaser whenever any non-packaged fireplace or stove wood is sold. The delivery ticket or sales invoice shall contain at least the following information:

- (a) the name and address of the vendor;
 - (b) the name and address of the purchaser;
 - (c) the date delivered;
 - (d) the quantity delivered and the quantity upon which the price is based, if this differs from the delivered quantity;
 - (e) the price of the amount delivered; and
 - (f) the identity, in the most descriptive terms commercially practicable, including any quality representation made in connection with the sale.
- (Added 1975)

2.5. Peat and Peat Moss. – Applies only with respect to organic matter of geological origin, excluding coal and lignite, originating principally from dead vegetative remains through the agency of water in the absence of air and occurring in a bog, swampland, or marsh, and containing an ash content not exceeding 25 % on a dry weight basis [dried in an oven at 105 °C (221 °F) until no further weight loss can be determined].

2.5.1. Declaration of Quantity. – The declaration of quantity of peat and peat moss shall be expressed in weight units or in cubic measure units.

2.5.2. Units.

2.5.2.1. Weight. – Peat and peat moss sold in terms of weight shall be offered and exposed for sale only in kilograms and/or pounds.

2.5.2.2. Cubic Measure. – Peat and peat moss sold in terms of cubic measure shall be offered and exposed for sale only in liters and/or cubic feet. If the commodity is labeled in terms of compressed cubic measurement, the quantity declaration shall represent the quantity in the compressed state.

(Added 1971) (Amended 1975, 1979, 1983, and 1997)

2.6. Prefabricated Utility Buildings. – Shall be offered for retail sale on the basis of usable inside space as follows:

- (a) length, measured from inside surface of wall panels at the base;
- (b) width, measured from inside surface of wall panels at the base;
- (c) height, measured from the base to the top of the shortest wall panel.

Inside dimensions in SI units shall be declared to the nearest 0.01 meter; inside dimensions in inch-pound units shall be declared to the nearest inch.

If total usable inside space is declared in a supplemental declaration, it shall be to the nearest cubic decimeter or cubic foot.

(Added 1975)

2.7. Roofing and Roofing Material. – Shall be sold by the square meter only if sold in SI units, by the square, or by the square foot only if sold in inch-pound units.

(Amended 1979)

2.7.1. Definitions.

2.7.1.1. Square Meter. – The quantity of roofing or roofing material that, when applied according to the directions or instructions of the manufacturer, will cover one square meter exclusive of side laps or side joints.

(Added 1979)

2.7.1.2. Square. – The quantity of roofing or roofing material that, when applied according to directions or instructions of the manufacturer, will cover an area of 100 ft² exclusive of side laps or side joints, provided, in the case of roofing or roofing material of corrugated design, the side lap or side joint shall be one full corrugation.

2.7.1.3. Square Foot. – The quantity of roofing or roofing material that, when applied according to the directions or instructions of the manufacturer, will cover 1 ft² (144 in²) exclusive of side laps or side joints.

2.7.2. Declaration of Quantity. – When the declaration of quantity on a package of roofing or roofing material contains the term “square,” it shall include, plainly and conspicuously, a numerical definition of the term “square.”

Example:

“One square covers 100 ft² of roof area.”

2.7.2.1. Common Fractions. – The use of the common fraction one-third ($\frac{1}{3}$) is specifically authorized in the quantity statement of a package of roofing or roofing material when, and only when, used as the common fraction of the “square.”

2.7.2.2. Quantity Statement. – The primary declaration if in inch-pound units shall only be in terms of squares or square feet, and if in metric units shall only be in terms of square meters. There is no prohibition against the use of supplementary quantity declarations, such as shingle dimensions, but in no case shall the weight of the material be stated or implied. However, the use of numerical descriptions for rolls of felt roofing material may continue to be used.

(Added 1971) (Amended 1979)

2.8. Sealants. – Caulking compounds, glazing compounds, and putty shall be sold in terms of liquid measure, except that rope caulk shall be sold by weight.

(Added 1971) (Amended 1981)

2.9. Sod and Turf.

2.9.1. Application. – For the purpose of this regulation, this section shall apply to all sod, including turf sod, turf plugs, and turf sprigs.

2.9.2. Definitions.

2.9.2.1. Sod. – Shall mean “turf sod,” “turf plugs,” or “turf sprigs” of a single kind or variety or a mixture of kinds and varieties.

2.9.2.2. Turf. – The live population of one or more kinds of grasses, legumes, or other plant species used for lawns, recreational use, soil erosion control, or other such purposes.

2.9.2.3. Turf plug. – A small section cut from live turf of those kinds of turf normally vegetatively propagated (such as zoysia grass) that when severed contain sufficient plant material to remain intact.

2.9.2.4. Turf sod. – A strip or section of live turf that when severed contains sufficient plant material to remain intact.

2.9.2.5. Turf sprig. – A live plant, stolon, crown, or section cut from stolonifera plants used as turf.

2.9.3. Quantity. – Sod shall be advertised, offered for sale, and sold by measure or by a combination of count and measure as prescribed by this subsection.

2.9.3.1. Turf sod. – Turf sod shall be advertised for sale and sold in terms of the square meter, square foot, or square yard, as appropriate.

(Amended 1979)

2.9.3.2. Turf plugs. – Turf plugs shall be advertised for sale and sold in terms of count, combined with a statement of the plug diameter.

2.9.3.3. Turf sprigs. – Turf sprigs shall be advertised for sale and sold in terms of the liter or bushel.

(Added 1976) (Amended 1979)

2.10. Softwood Lumber. – Applies to softwood boards, timbers, and dimension lumber that have been surfaced, but shall not apply to rough lumber, to lumber that has been matched, patterned, or shiplapped; or to lumber remanufactured or joined so as to have changed the form or identity, such as individually assembled or packaged millwork items. “Nominal sizes” for inch-pound dimensions are size designations used for convenience in describing approximate, rather than actual, sizes of lumber. “Nominal sizes” were originally derived from the dimensions of rough lumber before surfacing and are always greater than the actual dimensions; thus a dry “2 x 4” is surfaced to actual dimensions of 1½ in x 3½ in (38 mm x 89 mm). The requirements in this section refer to actual sizes of lumber; for nominal sizes (see Table 1. Softwood Lumber Sizes). The nominal sizes used in this section follow Department of Commerce Voluntary Product Standard PS 20-10, “American Softwood Lumber Standard,” or latest edition. SI equivalents are included for actual measurements only.

2.10.1. Definitions.

2.10.1.1. Surfaced (dressed) Lumber. – Lumber that has been surfaced by a machine (to attain smoothness of surface and uniformity of size) on one side (S1S), on two sides (S2S), one edge (S1E), two edges (S2E), or a combination of sides and edges (S1S1E, S1S2E, S2S1E, S4S).

2.10.1.2. Boards. – Lumber 38 mm (1½ in) or less in actual thickness and 38 mm (1½ in) or more in actual width. Lumber less than 139 mm (5½ in) in actual width may be classified as strips.

2.10.1.3. Timbers. – Lumber 114 mm (4½ in) or more in smallest dimension. Timbers may be designated as beams, stringers, posts, caps, sills, girders, or purlins.

2.10.1.4. Dimension Lumber. – Lumber from 38 mm (1½ in) to, but not including, 114 mm (4½ in) in actual thickness, and 38 mm (1½ in) or more in actual width. Dimension lumber may be designated as framing, joists, planks, rafters, or studs.

2.10.1.5. Rough Lumber. – Lumber that has not been surfaced, but that has been sawed, edged, and trimmed at least to the extent of showing saw marks, or other primary manufacturing marks in the wood, on the four longitudinal surfaces of each piece for its overall length.

2.10.1.6. Matched Lumber. – Lumber that has been worked with a tongue on one edge of each piece and a groove on the opposite edge to provide a close tongue and groove joint by fitting two pieces together; when end-matched, the tongue and groove are worked in the ends also.

2.10.1.7. Patterned Lumber. – Lumber that is shaped to a pattern or a molded form, in addition to being dressed, matched, or shiplapped, or any combination of these workings.

2.10.1.8. Shiplapped Lumber. – Lumber that has been worked or rabbeted on both edges of each piece to provide a closelapped joint by fitting two pieces together.

2.10.1.9. Grade. – The commercial designation assigned to lumber meeting specifications established by a nationally recognized grade rule writing organization.

2.10.1.10. Species. – The commercial name assigned to a species of trees.

2.10.1.11. Species Group. – The commercial name assigned to two or more individual species having similar characteristics.

2.10.1.12. Representation. – A “representation” shall be construed to mean any advertisement, offering, invoice, or the like that pertains to the sale of lumber.

2.10.1.13. Minimum Dressed Sizes (width and thickness). – The standardized width and thickness at which lumber is dressed when manufactured in accordance with the U.S. Department of Commerce Voluntary Product Standard PS 20-10), “American Softwood Lumber Standard,” or latest edition, and regional grading rules conforming to PS 20-10 or latest edition. (See Table 1. Softwood Lumber Sizes.)

2.10.2. Identity. – Representations shall include a declaration of identity that specifies the grade or grades, species or species group, and whether the lumber is unseasoned (green) or dry.

2.10.3. Quantity. – Representations shall be in terms of:

- (a) the number of pieces;
- (b) the minimum surfaced width and thickness; and
- (c) either the length of individual pieces or the lineal footage, except that the use of nominal dimensions shall be allowed as long as a table of minimum surfaced sizes is displayed prominently or the actual dimensions are prominently displayed to the customer and the term “nominal” or “nom” is also used in conjunction with any representation of dimensions.

| Table 1. Softwood Lumber Sizes | | | | |
|--|---|--------------------|---------------|--------------------|
| Minimum standard surfaced sizes at the time of manufacture for both unseasoned (green) and dry lumber as published by the U.S. Department of Commerce in Voluntary Product Standard PS 20-10 or latest edition. | | | | |
| Product Classification (Nominal Size) | Minimum Dressed Sizes** | | | |
| | Unseasoned | | Dry | |
| Inches | Inches | Millimeters | Inches | Millimeters |
| Surfaced Lumber* | | | | |
| 2 x 2 | 1 ⁹ / ₁₆ x 1 ⁹ / ₁₆ | 40 x 40 | 1½ x 1½ | 38 x 38 |
| 2 x 2½ | 1 ⁹ / ₁₆ x 2 ¹ / ₁₆ | 40 x 52 | 1½ x 2 | 38 x 51 |
| 2 x 3 | 1 ⁹ / ₁₆ x 2 ⁹ / ₁₆ | 40 x 65 | 1½ x 2½ | 38 x 64 |
| 2 x 4 | 1 ⁹ / ₁₆ x 3 ⁹ / ₁₆ | 40 x 90 | 1½ x 3½ | 38 x 89 |
| 2 x 6 | 1 ⁹ / ₁₆ x 5 ⁵ / ₈ | 40 x 143 | 1½ x 5½ | 38 x 140 |
| 2 x 8 | 1 ⁹ / ₁₆ x 7½ | 40 x 190 | 1½ x 7¼ | 38 x 184 |
| 2 x 10 | 1 ⁹ / ₁₆ x 9½ | 40 x 241 | 1½ x 9¼ | 38 x 235 |
| 2 x 12 | 1 ⁹ / ₁₆ x 11½ | 40 x 292 | 1½ x 11¼ | 38 x 286 |
| Board Lumber | | | | |
| 1 x 2 | ²⁵ / ₃₂ x 1 ⁹ / ₁₆ | 20 x 40 | ¾ x 1½ | 19 x 38 |
| 1 x 3 | ²⁵ / ₃₂ x 2 ⁹ / ₁₆ | 20 x 65 | ¾ x 2½ | 19 x 64 |
| 1 x 4 | ²⁵ / ₃₂ x 3 ⁹ / ₁₆ | 20 x 90 | ¾ x 3½ | 19 x 89 |
| 1 x 6 | ²⁵ / ₃₂ x 5 ⁵ / ₈ | 20 x 143 | ¾ x 5½ | 19 x 140 |
| 1 x 8 | ²⁵ / ₃₂ x 7½ | 20 x 190 | ¾ x 7¼ | 19 x 184 |
| 1 x 10 | ²⁵ / ₃₂ x 9½ | 20 x 241 | ¾ x 9¼ | 19 x 235 |
| 1 x 12 | ²⁵ / ₃₂ x 11½ | 20 x 292 | ¾ x 11¼ | 19 x 286 |
| *The dry thicknesses of nominal 3 in and 4 in lumber are 2½ in (64 mm) and 3½ in (89 mm); unseasoned thicknesses are 2 ⁹ / ₁₆ in (65 mm) and 3 ⁹ / ₁₆ (90 mm). Widths for these thicknesses are the same as shown above. | | | | |
| **PS 20-10 defines dry lumber as being 19 % or less in moisture content and unseasoned lumber as being over 19 % moisture content. The size of lumber changes approximately 1 % for each 4 % change in moisture content. Lumber stabilizes at approximately 15 % moisture content under normal use conditions. (Added 1971) | | | | |

(Added 1971) (Amended 1990 and 1993)

2.11. Carpet. – Anyone who sells carpet shall provide the purchaser with written statements at the time of sale giving the following information:

- (a) The name and address of the manufacturer.
- (b) The style name and roll number of the carpet.
- (c) The generic name of the fiber and the type of backing material.
- (d) The amount delivered (exact size shipped).
- (e) The price per square meter if sold in SI units, or the price per square foot if sold in inch-pound units, and the total price.

(Added 1977) (Amended 1979 and 1999)

2.12. Hardwood Lumber - Retail Sales. – The requirements of this section apply to retail sales of hardwood lumber, but not to hardwood flooring, molding, or other pre-formed products.

2.12.1. Definitions.

2.12.1.1. Board Foot. – The inch-pound unit of volume measurement for hardwood lumber. A board foot is the volume of a board 1 ft long, 1 ft wide, and 1 in thick or its equivalent (144 in³ of wood).

2.12.1.2. Surfaced Lumber. – Lumber that has been surfaced for the purpose of attaining smoothness of surface and uniformity of size.

2.12.1.3. Kiln Drying. – A specialized process used to minimize dimensional changes in service. Hardwood lumber used for most products must have moisture removed by placing it in a drying kiln with controlled humidity and heat for a period of time determined by the initial and the final moisture content, the species, and the thickness.

2.12.1.4. Surface Measure. – A rounded area measurement for hardwood lumber. The surface measure shall be determined by multiplying the full width of the piece in inches and fractions by the standard length (see Section 2.12.1.7. Standard Lengths) in feet, dividing by 12, and rounding up or down to the nearest whole square foot. (Fractions less than or equal to one-half square foot are rounded down and those greater than one-half square foot are rounded up.)

2.12.1.5. Species. – The commercial name assigned to a species of trees.

2.12.1.6. Species Group. – The commercial name assigned to two or more individual species having similar characteristics.

2.12.1.7. Standard Lengths. – 4, 5, 6, 7, 8, 9, 10, 11, 12, 13, 14, 15, or 16 feet. Fractional lengths are rounded down to the next lower standard length (for example, if a board is 6 ft 8 in long, its length is rounded down to 6 ft).

2.12.1.8. Stock Widths. – Special items manufactured to predetermined widths, normally for retail sale.

2.12.2. Identity. – Representations shall include a declaration of identity that specifies the species or species group.

2.12.3. Surfaced (S4S) Lumber Manufactured to Stock Widths.

2.12.3.1. Quantity. – Representations shall be in terms of one of the following:

- (a) by linear measure when surfaced width and thickness are stated; or
- (b) by count when length and surfaced width and thickness are stated; or
- (c) by surface measure (square feet) when a thickness is stated.

2.12.3.2. Representations. – The use of nominal dimensions shall be allowed if the table of Minimum Surfaced Sizes for Kiln Dried Hardwood Lumber or the actual dimensions are prominently displayed to the customer, and the term “nominal” or “nom” is used in conjunction with any representation of nominal dimensions.

2.12.3.3 Minimum surfaced sizes for Kiln Dried Lumber (width and thickness). – Table 2. Minimum Surfaced Sizes for Kiln Dried Hardwood Lumber shows the minimum sizes for the stock widths listed. This table includes dimensions for thicknesses of 1 in and 2 in thick stock lumber. Hardwood lumber is also manufactured in thicknesses of 1¼ in (1 in surfaced) and 1½ in (1³/₁₆in surfaced). For other thicknesses, use the nominal and minimum widths from the table. For example: a board with the nominal dimensions of 1¼ in x 4 in would have minimum thickness of 1 in and minimum width of 3½ in.

| SI Units for Thickness and Width | Thickness and Width in Inches | |
|---|--------------------------------------|----------------------|
| Minimum Sizes in Millimeters | Nominal Sizes | Minimum Sizes |
| 38 x 89 | 2 x 4 | 1½ x 3½ |
| 38 x 140 | 2 x 6 | 1½ x 5½ |
| 38 x 184 | 2 x 8 | 1½ x 7¼ |
| 38 x 235 | 2 x 10 | 1½ x 9¼ |
| 38 x 286 | 2 x 12 | 1½ x 11¼ |
| 19 x 19 | 1 x 1 | ¾ x ¾ |
| 19 x 38 | 1 x 2 | ¾ x 1½ |
| 19 x 63 | 1 x 3 | ¾ x 2½ |
| 19 x 89 | 1 x 4 | ¾ x 3½ |
| 19 x 140 | 1 x 6 | ¾ x 5½ |
| 19 x 184 | 1 x 8 | ¾ x 7¼ |
| 19 x 235 | 1 x 10 | ¾ x 9¼ |
| 19 x 286 | 1 x 12 | ¾ x 11¼ |

The dry thickness of nominal 1½ in lumber is 1³/₁₆ in. The dry thickness of nominal 1¼ in lumber is 1 in. Sizes are shown in inches and millimeters. Minimum sizes in millimeters are calculated by multiplying the size in inches by 25.4 and rounding to the nearest millimeter. The rule for rounding is: round up for numbers greater than 0.50 mm and round down for numbers less than or equal to 0.50 mm. In case of a dispute on size measurements, the inch measurement takes precedence. Nominal and minimum widths for these thicknesses are shown above. The SI equivalents for 1 in and 1³/₁₆ in lumber are 25.4 mm and 30.1 mm, respectively.

2.12.4. Random Width Lumber.

2.12.4.1. Sales of Random Width Hardwood Lumber. – Sales of random width hardware lumber measured after kiln drying shall be quoted, invoiced, and delivered on the basis of net board footage with no addition of footage for kiln drying shrinkage or surfacing. Sales of hardwood lumber measured and sold prior to kiln drying or surfacing shall be quoted, invoiced, and delivered on the basis of net board footage before kiln drying or surfacing. If the lumber is to be kiln dried or surfaced at the request of the purchaser, the kiln drying or surfacing charge shall be clearly shown and identified on the quotation and invoice.

(Amended 1993)

2.13. Polyethylene Products.

2.13.1. Consumer and Non-consumer Products. – Offered and exposed for sale shall be sold in the terms given in Section 2.13.1.1. Sheeting and film.

2.13.1.1. Sheeting and Film.

Consumer products shall include quantity statements in both SI and inch-pound units.

Consumer products:

- (a) length and width (in SI and inch-pound units)
- (b) area (in square meters and square feet)
- (c) thickness (in micrometers and mils ^[NOTE 4, page 124])
- (d) weight (in SI and inch-pound units)

Non-Consumer Products:

- (a) length and width (in SI or inch-pound units)
 - (b) area (in square meters or square feet)
 - (c) thickness (in micrometers or mils ^[NOTE 4, page 124])
 - (d) weight (in SI or inch-pound units)
- (Added 1982) (Amended 1979, 1993, and 1998)

NOTE 4: $1 \text{ mil} = 0.001 \text{ in} = 25.4 \text{ micrometers } (\mu\text{m})$. $1 \text{ micrometer} = 0.000 \text{ 039 37 in}$.

(Amended 1993)

2.13.2. Consumer Products. – at retail shall be sold in the terms given in Section 2.13.2.1. Food wrap, Section 2.13.2.2. Lawn and trash bags, and Section 2.13.2.3. Food and sandwich bags.

2.13.2.1. Food Wrap.

- (a) length and width
 - (b) area in square meters and square feet
- (Amended 1979)

2.13.2.2. Lawn and Trash Bags.

- (a) count
- (b) dimensions
- (c) thickness in micrometers and mils
(Amended 1993)
- (d) capacity ^[NOTE 5, page 125]

2.13.2.3. Food and Sandwich Bags.

The capacity statement does not apply to fold-over sandwich bags.

- (a) count
- (b) dimensions
- (c) capacity ^[NOTE 5, page 125]

NOTE 5: See Section 10.8.2. Capacity of the Uniform Packaging and Labeling Regulation.

2.13.3. Non-consumer Products. – Shall be offered and exposed for sale in the terms given in Section 2.13.3.1. Bags. (Package shall be labeled in SI or inch-pound units and may include both units.)
(Amended 1998)

2.13.3.1. Bags.

- (a) count
- (b) dimensions
- (c) thickness in micrometers or mils
- (d) weight
- (e) capacity ^[NOTE 5, page 125]

2.13.4. Declaration of Weight. – The labeled statement of weight for polyethylene sheeting and film products under Sections 2.13.1.1. Sheeting and film, and 2.13.3.1. Bags, shall be equal to or greater than the weight calculated by using the formula below. The final value shall be calculated to four digits, and declared to three digits, dropping the final digit as calculated (for example, if the calculated value is 2.078 lb, then the declared net weight shall be 2.07 lb).

For SI dimensions:

$M = T \times A \times D / 1000$, where:

- M = net mass in kilograms
- T = nominal thickness in centimeters
- A = nominal length in centimeters times nominal width ^[NOTE 6, page 126] in centimeters
- D = minimum density in grams per cubic centimeter as defined by the latest version of ASTM Standard D1505, “Standard Test Method for Density of Plastics by the Density-Gradient

Technique” and the latest version of ASTM Standard D883, “Standards Terminology Relating to Plastics.”

For the purpose of this regulation, the minimum density (D) for linear low density polyethylene plastics (LLDPE) shall be 0.92 g/cm³ (when D is not known).

For the purpose of this regulation, the minimum density (D) for linear medium density polyethylene plastics (LMDPE) shall be 0.93 g/cm³ (when D is not known).

For the purpose of this regulation, the minimum density (D) for high density polyethylene plastics (HDPE) shall be 0.94 g/cm³ (when D is not known).

For inch-pound dimensions:

$W = T \times A \times 0.03613 \times D$, where:

W = net weight in pounds

T = nominal thickness in inches;

A = nominal length in inches times nominal width [NOTE 6, page 126] in inches

D = minimum density in grams per cubic centimeter as defined by the latest version of ASTM Standard D1505, “Standard Test Method for Density of Plastics by the Density-Gradient Technique” and the latest version of ASTM Standard D883, “Standards Terminology Relating to Plastics.”

0.03613 is a factor for converting g/cm³ to lb/in³

For the purpose of this regulation, the minimum density (D) for linear low density polyethylene plastics (LLDPE) shall be 0.92 g/cm³ (when D is not known).

For the purpose of this regulation, the minimum density (D) for linear medium density polyethylene plastics (LMDPE) shall be 0.93 g/cm³ (when D is not known).

For the purpose of this regulation, the minimum density (D) for high density polyethylene plastics (HDPE) shall be 0.94 g/cm³ (when D is not known).

(Added 1977) (Amended 1980, 1982, 1987, 1989, 1990, 1993, and 2012)

NOTE 6: *The nominal width for bags in this calculation is twice the labeled width.*

2.14. Insulation.

2.14.1. Packaged Loose-Fill Insulation Except Cellulose. – The label shall declare:

- (a) the type of insulation and the net weight with no qualifying statement; and
- (b) the minimum thickness, maximum net coverage area, and minimum weight per square foot at R values of 11, 19, and 22. This information shall also be supplied for any additional R values listed.

(Amended 1990)

2.14.2. Packaged Loose-Fill Cellulose Insulation. – The label shall declare:

- (a) the type of insulation and the net weight with no qualifying statement; and

- (b) the minimum thickness, maximum net coverage area, number of bags per 1000 ft², and minimum weight per square foot at R values of 13, 19, 24, 32, and 40. This information shall also be supplied for any additional R values listed.

(Amended 1990)

2.14.3. Batt and Blanket Insulation. – The principal display panel of packaged batt or blanket insulation shall declare the square feet of insulation in the package and the length and width of the batt or blanket. In addition, R value and thickness shall be declared on the package.

2.14.4. Installed Insulation. – Installed insulation must be accompanied by a contract or receipt. For all insulation except loose-fill and aluminum foil, the receipt must show the coverage area, thickness, and R value of the insulation installed. For loose-fill, the receipt must show the coverage area, thickness, and R value of the insulation, plus the number of bags used. For aluminum foil, the receipt must show the number and thickness of the air spaces, the direction of heat flow, and R value. The receipt must be dated and signed by the installer.

Example: This is to certify that the insulation has been installed in conformance with the requirements indicated by the manufacturer to provide a value of R 19 using 31.5 bags of insulation to cover 1500 ft² area. Signed and dated.

(Added 1979) (Amended 1983)

2.15. Solid Fuel Products. – Anthracite, semi anthracite, bituminous, semi-bituminous or lignite coal, and any other natural, manufactured, or patented fuel, not in liquid or gaseous form, except fireplace and stove wood, shall be offered, exposed for sale, or sold by net weight when in package form.

(Added 1979)

2.16. Compressed or Liquefied Gases in Refillable Cylinders.

2.16.1. Application. – This section does not apply to disposable cylinders of compressed or liquefied gases.

2.16.2. Net Contents. – The net contents shall be expressed in terms of cubic meters or cubic feet, kilograms, or pounds and ounces. See Section 2.21. Liquefied Petroleum Gas for permitted expressions of net contents for liquefied petroleum gas. A standard cubic foot of gas is defined as a cubic foot at a temperature of 21 °C (70 °F) and a pressure of 101.35 kilopascals (14.696 psia), except for liquefied petroleum gas as stated in Section 2.21.

2.16.3. Cylinder Labeling. – Whenever cylinders are used for the sale of compressed or liquefied gases by weight, or are filled by weight and converted to volume, the following shall apply:

2.16.3.1. Tare weights.

- (a) **Stamped or Stenciled Tare Weight.** – For safety purposes, the tare weight shall be legibly and permanently stamped or stenciled on the cylinder. All tare weight values shall be preceded by the letters “TW” or the words “tare weight.” The tare weight shall include the weight of the cylinder (including paint), valve, and other permanent attachments. The weight of a protective cap shall not be included in tare or gross weights. The Code of Federal Regulations Title 49, Section 178.50-22 requires the maker of cylinders to retain test reports verifying the cylinder tare weight accuracy to a tolerance of 1 %.

- (b) **Tare Weight for Purposes of Determining the Net Contents.** – The tare weight used in the determination of the final net contents may be either:

- (1) the stamped or stenciled tare weight; or
- (2) the actual tare determined at the time of filling the cylinder. If the actual tare is determined at the time of filling the cylinder, it must be legibly marked on the cylinder or on a tag attached to the cylinder at the time of filling.

(c) **Allowable difference.** – If the stamped or stenciled tare is used to determine the net contents of the cylinder, the allowable difference between the actual tare weight and the stamped (or stenciled) tare weight, or the tare weight on a tag attached to the cylinder for a new or used cylinder, shall be:

(1) ½ % for tare weights of 9 kg (20 lb) or less; or

(2) ¼ % for tare weights of more than 9 kg (20 lb).

(d) **Average requirement.** – When used to determine the net contents of cylinders, the stamped or stenciled tare weights of cylinders at a single place of business found to be in error predominantly in a direction favorable to the seller and near the allowable difference limit shall be considered to be not in conformance with these requirements.

2.16.3.2. Acetylene Gas Cylinder Tare Weights. – Acetone in the cylinder shall be included as part of the tare weight.

2.16.3.3. Acetylene Gas Cylinder Volumes. – The volumes of acetylene shall be determined from the product weight using approved tables such as those published in NIST Handbook 133 or those developed using 70 °F (21 °C) and 14.7 ft³ (101.35 kPa) per pound at 1 atmosphere as conversion factors.

2.16.3.4. Compressed Gases such as Oxygen, Argon, Nitrogen, Helium, and Hydrogen. – The volumes of compressed gases such as oxygen, argon, nitrogen, helium, or hydrogen shall be determined using the tables and procedures given in NIST Technical Note 1079, Tables of Industrial Gas Container Contents and Density for Oxygen, Argon, Nitrogen, Helium, and Hydrogen and supplemented by additional procedures and tables in NIST Handbook 133.

(Added 1981) (Amended 1990)

2.17. Precious Metals.

2.17.1. Definition.

2.17.1.1. Precious Metals. – Gold, silver, platinum, or any item composed partly or completely of these metals or their alloys and in which the market value of the metal in the item is principally the gold, silver, or platinum component.

2.17.2. Quantity. – The unit of measure and the method of sale of precious metals, if the price is based in part or wholly on a weight determination, shall be either troy weight or SI units. When the measurement or method of sale is expressed in SI units of mass, a conversion chart to troy units shall be prominently displayed so as to facilitate price comparison. The conversion chart shall also display a table of troy weights indicating grains, pennyweights, and troy ounces.

(Added 1982)

2.18. Mulch.

2.18.1. Definition.

2.18.1.1. Mulch. – Any product or material except peat or peat moss (see Section 2.5. Peat and Peat Moss) that is advertised, offered for sale, or sold for primary use as a horticultural, aboveground dressing, for decoration, moisture control, weed control, erosion control, temperature control, or other similar purposes.

(Added 1987)

2.18.2. Quantity. – All mulch shall be sold, offered, or exposed for sale in terms of volume measure in SI units in terms of the cubic meter or liter or in inch-pound units in terms of the cubic yard or cubic foot.

(Added 1983) (Amended 1987)

2.19. Kerosene (Kerosine). – All kerosene kept, offered, exposed for sale, or sold shall be identified as such and will include, with the word kerosene, an indication of its compliance with the latest version of the standard specification ASTM Standard D3699, “Standard Specification for Kerosine.”

Example:

1K Kerosene; Kerosene - 2K.

(Added 1983)

2.19.1. Retail Sale from Bulk. – All kerosene kept, offered, or exposed for sale and sold from bulk at retail shall be in terms of the gallon or liter.

(Added 2012)

2.20. Gasoline-Oxygenate Blends.

2.20.1. Method of Retail Sale. – Type of Oxygenate must be Disclosed. – All automotive gasoline or automotive gasoline-oxygenate blends kept, offered, or exposed for sale, or sold at retail containing at least 1.5 mass percent oxygen shall be identified as “with” or “containing” (or similar wording) the predominant oxygenate in the engine fuel. For example, the label may read “contains ethanol” or “with MTBE.” The oxygenate contributing the largest mass percent oxygen to the blend shall be considered the predominant oxygenate. Where mixtures of only ethers are present, the retailer may post the predominant oxygenate followed by the phrase “or other ethers” or alternatively post the phrase “contains MTBE or other ethers.” In addition, gasoline-methanol blend fuels containing more than 0.15 mass percent oxygen from methanol shall be identified as “with” or “containing” methanol. This information shall be posted on the upper 50 % of the dispenser front panel in a position clear and conspicuous from the driver’s position in a type at least 12.7 mm (½ in) in height, 1.5 mm (1/16 in) stroke (width of type).

(Amended 1996)

2.20.2. Documentation for Dispenser Labeling Purposes. – At the time of delivery of the fuel, the retailer shall be provided, on an invoice, bill of lading, shipping paper, or other documentation a declaration of the predominant oxygenate or combination of oxygenates present in concentrations sufficient to yield an oxygen content of at least 1.5 mass percent in the fuel. Where mixtures of only ethers are present, the fuel supplier may identify either the predominant oxygenate in the fuel (i.e., the oxygenate contributing the largest mass percent oxygen) or, alternatively, use the phrase “contains MTBE or other ethers.” In addition, any gasoline containing more than 0.15 mass percent oxygen from methanol shall be identified as “with” or “containing” methanol. This documentation is only for dispenser labeling purposes; it is the responsibility of any potential blender to determine the total oxygen content of the engine fuel before blending.

(Added 1984) (Amended 1985, 1986, 1991, and 1996)

2.21. Liquefied Petroleum Gas. – All liquefied petroleum gas, including, but not limited to propane, butane, and mixtures thereof, shall be kept, offered, exposed for sale, or sold by the pound, metered cubic foot ^[NOTE 7, page 127] of vapor (defined as 1 ft³ at 60 °F [15.6 °C]), or the gallon (defined as 231 in³ at 60 °F [15.6 °C]). All metered sales by the gallon, except those using meters with a maximum rated capacity of 20 gal/min or less, shall be accomplished by use of a meter and device that automatically compensates for temperature.

(Added 1986)

NOTE 7: Sources: American National Standards Institute, Inc., “American National Standard for Gas Displacement Meters (500 Cubic Feet per Hour Capacity and Under),” First edition, 1974, and NIST Handbook 44, “Specifications, Tolerances, and Other Technical Requirements for Weighing and Measuring Devices.”

2.22. Liquid Oxygen Used for Respiration.

- (a) If sold by weight, liquid oxygen must be weighed on an appropriate, sealed commercial scale. A pressure or other type of gauge may not be used to determine weight.
 - (b) A delivery ticket or sales invoice shall be provided and shall contain at least the following information:
 - (1) date delivered;
 - (2) name and address of vendor;
 - (3) name and address of the purchaser;
 - (4) if sold by weight:
 - i. weight of cylinder before filling;
 - ii. weight of cylinder after filling; and
 - iii. the net weight of liquid oxygen delivered;
 - (5) if sold by measure:
 - i. measurement and any computation used to arrive at the net quantity of liquid oxygen delivered;
 - (6) the unit price;
 - (7) the total computed price; and
 - (8) weigher's or measurer's signature.
- (Added 1989)

2.23. Animal Bedding. – Packaged animal bedding of all kinds, except for baled straw, shall be sold by volume, that is, by the cubic meter, liter, or milliliter and by the cubic yard, cubic foot, or cubic inch. If the commodity is packaged in a compressed state, the quantity declaration shall include both the quantity in the compressed state and the usable quantity that can be recovered. Compressed animal bedding packages shall not include pre-compression volume statements.

Example:

250 mL expands to 500 mL (500 in³ expands to 1000 in³).

(Added 1990) (Amended 2012)

2.23.1. Exemption - Non-Consumer Packages Sold to Laboratory Animal Research Industry. – Packaged animal bedding consisting of granular corncobs and other dry (8 % or less moisture), pelleted, and/or non-compressible bedding materials that are sold to commercial (non-retail) end users in the laboratory animal research industry (government, medical, university, preclinical, pharmaceutical, research, biotech, and research institutions) may be sold on the basis of weight.

(Added 2010)

2.24. Wiping Cloths. – Wiping cloths shall be sold by net weight or by count plus size of wiping cloths. When sold by count plus size, and the wiping cloths are of assorted sizes, the term “irregular dimensions” and the minimum size of such cloths must be declared. The gross weight may not be printed on any package, either consumer or non-consumer.

(Added 1991)

2.25. Baler Twine. – Baler twine shall be sold on the basis of length in meters or feet, and net mass or weight by kilograms or pounds.

(Added 1992)

2.26. Potpourri. – Potpourri shall be sold as follows:

- (a) Potpourri packaged in advance of sale shall be sold by weight, except when sold in a decorative container or sachet, which may be sold by count.
- (b) Potpourri sold from bulk shall be sold by weight or by dry volume.

(Added 1992)

2.27. Retail Sales of Natural Gas Sold as a Vehicle Fuel.

2.27.1. Definitions.

2.27.1.1. Natural Gas. – A gaseous fuel composed primarily of methane that is suitable for compression and dispensing into a fuel storage container(s) for use as an engine fuel.

2.27.1.2. Gasoline liter equivalent (GLE). – Gasoline liter equivalent (GLE) means 0.678 kg of natural gas.

2.27.1.3. Gasoline gallon equivalent (GGE). – Gasoline gallon equivalent (GGE) means 2.567 kg (5.660 lb) of natural gas.

2.27.1.4. Diesel liter equivalent (DLE). – means 0.756 kg of natural gas.
(Added 2013)

2.27.1.5. Diesel gallon equivalent (DGE). – means 2.821 kg (6.22 lb) of natural gas.
(Added 2013)

2.27.2. Method of Retail Sale and Dispenser Labeling.

2.27.2.1. Method of retail sale. – All natural gas kept, offered, or exposed for sale and sold at retail as a vehicle fuel shall be in terms of

- (a) The gasoline liter equivalent (GLE) or gasoline equivalent (GGE); or
 - (b) The diesel liter equivalent (DLE) or diesel gallon equivalent (DGE).
- (Amended 2013)

2.27.2.2. Dispenser labeling. – All retail natural gas dispensers shall be labeled with the conversion factor in terms of kilograms or pounds. The label shall be permanently and conspicuously displayed on the face of the dispenser and shall

(a) either the statement “1 Gasoline Liter Equivalent (GLE) is equal to 0.678 kg of Natural Gas or “1 Gasoline Gallon Equivalent (GGE) is equal to 5.660 lb of Natural Gas” consistent with the method of sale used; or

(b) either the statement “1 Diesel Liter Equivalent (DLE) is equal to 0.756 kg of Natural Gas or “1 Diesel Gallon Equivalent (DGE) is equal to 6.22 lb of Natural Gas” consistent with the method of sale used.

(Amended 2013)

2.28. Communication Paper.

2.28.1. Definitions.

2.28.1.1. Communication Paper. – Packaged bond, mimeo, spirit duplicator, xerographic, and other papers, including cut-sized office paper and computer paper.

2.28.1.2. Basis Weight. – As used in this regulation for labeling means the grade, category, or identity of the paper determined according to the latest version of ASTM Standard Method D646, “Grammage of Paper and Paperboard.” Basis weight is used as a standard of identity and is not considered a net weight declaration.

2.28.2. Method of Retail Sale and Labeling.

2.28.2.1. Method of Retail Sale. – All packaged communication paper kept, offered, or exposed for sale and sold at retail shall be sold in terms of sheet length and width and count.

2.28.2.2. Labeling. – Communication paper in package form shall bear a label that includes:

- (a) a declaration of quantity, in terms of sheet length and width and count, in the lower 30 % of the principal display panel.
- (b) a declaration of identity including the basis weight, and may include such other information as grain direction, color, brightness, printed lines, and hole punch information. Due to the variation in basis weight in manufacturing and analysis, the basis weight declared on the label shall correspond to the basis weight declared by the original manufacturer.

(Added 1994)

2.29. Sand, Rock, Gravel, Stone, Paving Stone, and Similar Materials, when Sold in Bulk. – All sand, rock, gravel, stone, paving stone, and similar materials kept, offered, or exposed for sale in bulk must be sold as follows:

- (a) Top soil, fill dirt, aggregate or chipped rock, sand (including concrete and mortar sand), decomposed granite, landscape type rock, and cinders must be sold by the cubic meter or cubic yard or by weight.
- (b) Flagstone must be sold by weight.
- (c) Dimensional cut stone must be sold by square meter, square foot, or weight.
- (d) This requirement does not apply to single stones with engraving such as gravestones, natural or manmade artwork, landscape boulders, and pre-cast uniform size blocks.

(Added 2000)

2.30. E85 Fuel Ethanol.

2.30.1. How to Identify Fuel Ethanol. – Fuel ethanol shall be identified as E85.

2.30.2. Labeling Requirements.

- (a) Fuel ethanol shall be labeled with its automotive fuel rating in accordance with 16 Code of Federal Regulations Part 306.

- (b) A label shall be posted which states “For Use in Flexible Fuel Vehicles (FFV) Only.” This information shall be clearly and conspicuously posted on the upper 50 % of the dispenser front panel in a type at least 12.7 mm (½ in) in height, 1.5 mm (1/16 in) stroke (width of type). A label shall be posted which states, “Consult Vehicle Manufacturer Fuel Recommendations,” and shall not be less than 6 mm (¼ in) in height by 0.8 mm (1/32 in) stroke; block style letters and the color shall be in definite contrast to the background color to which it is applied.

(Added 2007)

2.31. Biodiesel and Biodiesel Blends.

2.31.1. Identification of Product. – Biodiesel shall be identified by the term “Biodiesel” with the designation “B100.” Biodiesel Blends shall be identified by the term “Biodiesel Blend.”

2.31.2. Labeling of Retail Dispensers.

2.31.2.1. Labeling of Grade Required. – Biodiesel shall be identified by the grades S15 or S500. biodiesel blends shall be identified by the grades No. 1-D, No. 2-D, or No. 4-D.

2.31.2.2. EPA Labeling Requirements also Apply. – Retailers and wholesale purchaser-consumers of biodiesel blends shall comply with EPA pump labeling requirements for sulfur under 40 CFR § 80.570.

2.31.2.3. Automotive Fuel Rating. – Biodiesel and biodiesel blends shall be labeled with its automotive fuel rating in accordance with 16 CFR Part 306.

2.31.2.4. Biodiesel Blends. – When biodiesel blends greater than 20 % by volume are offered by sale, each side of the dispenser where fuel can be delivered shall have a label conspicuously placed that states “Consult Vehicle Manufacturer Fuel Recommendations.” The lettering of this legend shall not be less than 6 mm (¼ in) in height by 0.8 mm (1/32 in) stroke; block style letters and the color shall be in definite contrast to the background color to which it is applied.

2.31.3. Documentation for Dispenser Labeling Purposes. – The retailer shall be provided, at the time of delivery of the fuel, a declaration of the volume percent biodiesel on an invoice, bill of lading, shipping paper, or other document. This documentation is for dispenser labeling purposes only; it is the responsibility of any potential blender to determine the amount of biodiesel in the diesel fuel prior to blending.

2.31.4. Exemption. – Biodiesel blends that contain less than or equal to 5 % biodiesel by volume are exempt from the requirements of Sections 2.31.1. Identification of Product, 2.31.2. Labeling of Retail Dispensers, and 2.31.3. Documentation for Dispenser Labeling Purposes when it is sold as diesel fuel.

(Added 2008)

2.32. Retail Sales of Hydrogen Fuel (H).

2.32.1. Definitions for Hydrogen Fuel. – A fuel composed of molecular hydrogen intended for consumption in a surface vehicle or electricity production device with an internal combustion engine or fuel cell.

(Amended 2012)

2.32.2. Method of Retail Sale and Dispenser Labeling. – All hydrogen fuel kept, offered, or exposed for sale and sold at retail shall be in mass units in terms of the kilogram. The symbol for hydrogen vehicle fuel shall be the capital letter “H” (the word Hydrogen may also be used).

2.32.3. Retail Dispenser Labeling.

- (a) A computing dispenser must display the unit price in whole cents on the basis of price per kilogram.

- (b) The service pressure(s) of the dispenser must be conspicuously shown on the user interface in bar or the SI unit of pascal (Pa) (e.g., MPa).
- (c) The product identity must be shown in a conspicuous location on the dispenser.
- (d) National Fire Protection Association (NFPA) labeling requirements also apply.
- (e) Hydrogen shall be labeled in accordance with 16 CFR 309 – FTC Labeling Alternative Fuels.

2.32.4. Street Sign Prices and Advertisements.

- (a) The unit price must be in terms of price per kilogram in whole cents (e.g., \$3.49 per kg, not \$3.499 per kg).
- (b) The sign or advertisement must include the service pressure (expressed in megapascals) at which the dispenser(s) delivers hydrogen fuel (e.g., H35 or H70).

(Added 2010)

2.33. Oil.

2.33.1. Labeling of Vehicle Engine (Motor) Oil. – Vehicle engine (motor) oil shall be labeled.

2.33.1.1. Viscosity. – The label on any vehicle engine (motor) oil container, receptacle, dispenser, or storage tank, and any invoice or receipt from service on an engine that includes the installation of vehicle engine (motor) oil dispensed from a receptacle, dispenser, or storage tank, shall contain the viscosity grade classification preceded by the letters “SAE” in accordance with SAE International’s latest version of SAE J300, “Engine Oil Viscosity Classification.”

2.33.1.2. Intended Use. – The label on any vehicle engine (motor) oil container shall contain a statement of its intended use in accordance with the latest version of SAE J183, “Engine Oil Performance and Engine Service Classification (other than Energy Conserving).”

2.33.1.3. Brand. – The label on any vehicle engine (motor) oil container and the invoice or receipt from service on an engine that includes the installation of vehicle engine (motor) oil dispensed from a receptacle, dispenser, or storage tank shall contain the name, brand, trademark, or trade name of the vehicle engine (motor) oil.

2.33.1.4. Engine Service Category. – The label on any vehicle engine (motor) oil container, receptacle, dispenser, or storage tank and the invoice or receipt from service on an engine that includes the installation of vehicle engine (motor) oil dispensed from a receptacle, dispenser, or storage tank shall contain the engine service category, or categories, displayed in letters not less than 3.18 mm (¹/₈ in) in height, as defined by the latest version of SAE J183, “Engine Oil Performance and Engine Service Classification (other than Energy Conserving)” or API Publication 1509, “Engine Oil Licensing and Certification System.”

2.33.1.4.1. Inactive or Obsolete Service Categories. – The label on any vehicle engine (motor) oil container, receptacle, dispenser, or storage tank and the invoice or receipt from service on an engine that includes the installation of vehicle engine (motor) oil dispensed from a receptacle, dispenser, or storage tank shall bear a plainly visible cautionary statement in compliance with the latest version of SAE J183, Appendix A, whenever the vehicle engine (motor) oil in the container or in bulk does not meet an active API service category as defined by the latest version of SAE J183, “Engine Oil Performance and Engine Service Classification (other than Energy Conserving).”

2.33.1.5. Tank Trucks or Rail Cars. – Tank trucks, rail cars, and other types of delivery trucks that are used to deliver vehicle engine (motor) oil are not required to display the SAE viscosity grade and service

category or categories as long as the bill of lading or other documentation provides that information on such tank trucks, rail cars, and other types of delivery trucks.

All references to invoice or receipt will be enforceable effective on July 1, 2013.

(Amended 2013)

2.33.1.6. Documentation. – When the engine (motor) oil is sold in bulk, an invoice, bill of lading, shipping paper, or other documentation must accompany each delivery. This document must identify the quantity of engine (motor) oil delivered as defined in Sections 2.33.1.1. Viscosity; 2.33.1.2. Intended Use; 2.33.1.3. Brand; 2.33.1.4. Engine Service Category; the name and address of the seller and buyer; and the date and time of the sale. For inactive or obsolete service categories, the documentation shall also bear a plainly visible cautionary statement as required in Section 2.33.1.4.1. Inactive or Obsolete Service Categories, documentation must be retained at the retail establishment for a period of not less than one year.

(Added 2013)

(Added 2012) (Amended 2013)

2.34. Retail Sales of Electricity Sold as a Vehicle Fuel.

2.34.1. Definitions.

2.34.1.1. Electricity Sold as Vehicle Fuel. – Electrical energy transferred to and/or stored onboard an electric vehicle primarily for the purpose of propulsion.

2.34.1.2. Electric Vehicle Supply Equipment (EVSE). – The conductors, including the ungrounded, grounded, and equipment grounding conductors; the electric vehicle connectors; attachment plugs; and all other fittings, devices, power outlets, or apparatuses installed specifically for the purpose of measuring, delivering, and computing the price of electrical energy delivered to the electric vehicle.

2.34.1.3. Fixed Service. – Service that continuously provides the nominal power that is possible with the equipment as it is installed.

2.34.1.4. Variable Service. – Service that may be controlled resulting in periods of reduced, and/or interrupted transfer of electrical energy.

2.34.1.5. Nominal Power. – Refers to the “intended” or “named” or “stated” as opposed to “actual” rate of transfer of electrical energy (i.e., power).

2.34.2. Method of Sale. – All electrical energy kept, offered, or exposed for sale and sold at retail as a vehicle fuel shall be in units in terms of the megajoule (MJ) or kilowatt-hour (kWh). In addition to the fee assessed for the quantity of electrical energy sold, fees may be assessed for other services; such fees may be based on time measurement and/or a fixed fee.

2.34.3. Retail Electric Vehicle Supply Equipment (EVSE) Labeling.

(a) A computing EVSE shall display the unit price in whole cents (e.g., \$0.12) or tenths of one cent (e.g., \$0.119) on the basis of price per megajoule (MJ) or kilowatt-hour (kWh). In cases where the electrical energy is unlimited or free of charge, this fact shall be clearly indicated in place of the unit price.

(b) For fixed service applications, the following information shall be conspicuously displayed or posted on the face of the device:

(1) the level of EV service expressed as the nominal power transfer (i.e., nominal rate of electrical energy transfer), and

- (2) the type of electrical energy transfer (e.g., AC, DC, wireless).
- (c) For variable service applications, the following information shall be conspicuously displayed or posted on the face of the device:
 - (1) the type of delivery (i.e., variable);
 - (2) the minimum and maximum power transfer that can occur during a transaction, including whether service can be reduced to zero;
 - (3) the condition under which variations in electrical energy transfer will occur; and
 - (4) the type of electrical energy transfer (e.g., AC, DC, wireless).
- (d) Where fees will be assessed for other services in direct connection with the fueling of the vehicle, such as fees based on time measurement and/or a fixed fee, the additional fees shall be displayed.
- (e) The EVSE shall be labeled in accordance with 16 CFR, Part 309 – FTC Labeling Requirements for Alternative Fuels and Alternative Fueled Vehicles.
- (f) The EVSE shall be listed and labeled in accordance with the National Electric Code® (NEC) NFPA 70, Article 625 Electric Vehicle Charging Systems (www.nfpa.org).

2.34.4. Street Sign Prices and Other Advertisements. – Where electrical energy unit price information is presented on street signs or in advertising other than on EVSE:

- (a) The electrical energy unit price shall be in terms of price per megajoule (MJ) or kilowatt-hour (kWh) in whole cents (e.g., \$0.12) or tenths of one cent (e.g., \$0.119). In cases where the electrical energy is unlimited or free of charge, this fact shall be clearly indicated in place of the unit price.
- (b) In cases where more than one electrical energy unit price may apply over the duration of a single transaction to sales to the general public, the terms and conditions that will determine each unit price and when each unit price will apply shall be clearly displayed.
- (c) For fixed service applications, the following information shall be conspicuously displayed or posted:
 - (1) the level of EV service expressed as the nominal power transfer (i.e., nominal rate of electrical energy transfer), and
 - (2) the type of electrical energy transfer (e.g., AC, DC, wireless).
- (d) For variable service applications, the following information shall be conspicuously displayed or posted:
 - (1) the type of delivery (i.e., variable);
 - (2) the minimum and maximum power transfer that can occur during a transaction, including whether service can be reduced to zero;
 - (3) the conditions under which variations in electrical energy transfer will occur; and
 - (4) the type of electrical energy transfer (e.g., AC, DC, wireless).

Where fees will be assessed for other services in direct connection with the fueling of the vehicle, such as fees based on time measurement and/or a fixed fee, the additional fees shall be included on all street signs or other advertising.

(Added 2013)

Section 3. General

3.1. Presentation of Price. – Whenever an advertised, posted, or labeled price per unit of weight, measure, or count for any commodity includes a fraction of a cent, all elements of the fraction shall be prominently displayed, and the numerals expressing the fraction shall be immediately adjacent to, of the same general design and style as, and at least one half the height and width of, the numerals representing the whole cent.

(Added 1976)

3.2. Allowable Differences: Combination Quantity Declarations. – Whenever the method of sale for a bulk or packaged commodity requires the use of a statement that includes count in addition to weight, measure, or size, the following shall apply to the particular commodity:

3.2.1. Beverageware: Pressed and Blown Tumblers and Stemware. – The allowable difference between actual and declared capacity shall be:

(a) **SI Units:**

- (1) plus or minus 10 mL for items of 200 mL capacity or less; and
 - (2) plus or minus 5 % of the stated capacity for items over 200 mL capacity.
- (Added 1973) (Amended 1974, 1979, and 1980)

(b) **Inch-pound Units:**

- (1) plus or minus ¼ fl oz for items of 5 fl oz capacity or less; and
- (2) plus or minus 5 % of the stated capacity for items over 5 fl oz capacity.

3.3. Labeling of Machines that Dispense Packaged Commodities. – All vending machines dispensing packaged commodities shall indicate:

- (a) product identity;
- (b) net quantity; and
- (c) the party responsible for the vending machine.

Examples:

“For service or refunds contact: the XYZ Cola Company, Rockville, MD 20800; Telephone: (301) 555-1000,” or “See attendant inside for refunds.”

(Amended 1995)

- (d) the requirements for product identity and net quantity can be met either by display of the package or by information posted on the outside of the machine.

(Added 1972)

3.4. Railroad Car Tare Weights. – Whenever stenciled tare weights on freight cars are employed in the sale of commodities or the assessment of freight charges, the following conditions and requirements shall apply:

3.4.1. Newly Stenciled Tare Weights. – All newly stenciled or re-stenciled tare weights shall be accurately represented to the nearest 50 kg for metric units and to the nearest 100 lb for inch-pound units, and the representation shall include the date of weighing.

(Amended 1979)

3.4.2. Allowable Difference. – The allowable difference between actual tare weight and stenciled tare weight on freight cars in use shall be per Section 3.4.2.(a) SI allowable difference or Section 3.4.2.(b) Inch-pound allowable difference.

(a) **SI allowable difference:**

- (1) plus or minus 150 kg for cars 25 000 kg or less;
- (2) plus or minus 200 kg for cars over 25 000 kg to and including 30 000 kg; and
- (3) plus or minus 250 kg for cars over 30 000 kg.

(Added 1979)

(b) **Inch-pound allowable difference:**

- (1) plus or minus 300 lb for cars 50 000 lb or less;
- (2) plus or minus 400 lb for cars over 50 000 lb to and including 60 000 lb; and
- (3) plus or minus 500 lb for cars over 60 000 lb.

3.4.3. Verification or Change of Tare Weights. – Tare weight determinations for verification or change of stenciled weights shall only be made on properly prepared and adequately cleaned freight cars.

3.4.4. Special Cars. – Tank cars, covered hopper cars, flat cars equipped with multi-deck racks or special superstructure, mechanical refrigerator cars, and house type cars equipped with special lading protective devices must be reweighed and re-stenciled only by owners or their authorized representatives:

- (a) when car bears no lightweight (empty weight) stenciling; and
- (b) when repairs or alterations result in a change of weight in excess of the permissible lightweight tolerance.

(Added 1974) (Renumbered 1985)

(Added 1973) (Amended 1974, 1979, and 1985)

Section 4. Revocation of Conflicting Regulations

All provisions of all orders and regulations heretofore issued on this same subject that are contrary to or inconsistent with the provisions of this regulation are hereby revoked.

(Added 1971)

Section 5. Effective Date

This regulation shall become effective on August 1, ~~2013~~2014.

(Added 1971) (Amended 1973)

|

MARKUP COPY

C. Uniform Unit Pricing Regulation

as adopted by
The National Conference on Weights and Measures*

1. Background

The Uniform Unit Pricing Regulation (UPR) (renamed in 1983) provides a national approach to the subject for those jurisdictions choosing to adopt such a regulation. The traditional approach of the Conference in drafting Uniform Regulations has been to design specific implementing Regulations for the enforcement of the broader requirements of the Uniform Weights and Measures Law. Given the authority of Sections 12.(c) and (d), and the mandate of Section 16. of this Law, as well as the trend in unit pricing, both voluntary and mandatory, the UPR is considered appropriate. Unit pricing has been a concern of the weights and measures official and has been required for random weight packages for a long time.

In 1993, the NCWM was contacted by several weights and measures jurisdictions and retail trade associations who requested that the UPR be updated to add new commodity groups and pricing requirements. The comments indicated that many commodity groups for non-food products were not included in the table and that some of the required units may not be appropriate for many of the new products being sold in stores. Another concern was that the UPR specified pricing only on the basis of price per pound on most products sold by weight. This has resulted in some jurisdictions not enforcing the requirements on stores that voluntarily unit price on the basis of price per ounce instead of price per pound. The NCWM agreed that the UPR should be revised to encourage wider adoption and use of the uniform regulation and that provisions for unit pricing in metric units should be included.

At the 1997 Annual Meeting, the NCWM adopted revisions to the regulation to permit retail stores that voluntarily provide unit pricing to present prices using various units of measure.

The NCWM eliminated the table of product groupings because it is difficult to keep it current and inclusive, so some newer products were not included under the uniform requirements. The table was replaced with requirements that specify that the unit price is to be based on price per ounce or pound, or price per 100 grams or kilogram, if the packaged commodity is labeled by weight. For example, the proposed revisions would require the unit price for soft drinks sold in various package sizes (e.g., 12 fl oz cans through 2 L bottles) to be uniformly and consistently displayed in terms of either price per fluid ounce, price per quart, or price per liter. The NCWM also increased the price of commodities exempted from unit pricing from 10 cents to 50 cents. The NCWM believed these revisions would ensure that unit pricing information facilitates value comparison between different package sizes and/or brands offered for sale in a store.

The NCWM also considered several comments on this item from members of the U.S. Metric Association (USMA). Most of these comments suggested that the UPR be amended to require unit pricing in metric units and permit inch-pound unit pricing to be provided voluntarily. When it developed the proposed revisions, the NCWM included guidelines for both inch-pound and metric unit pricing and believes this is the correct approach to implementing metric revisions in the regulation. The NCWM would like to make it clear that the UPR applies only when stores voluntarily provide unit pricing information. Its purpose is to provide a standard that retailers must follow to ensure that consumers will have pricing information that helps them make value comparisons. The decision to provide unit price information in metric or inch-pound units rests with retailers who will respond to consumer preference. The NCWM believes that consumer preference will be the deciding factor as to when and how quickly metric unit pricing is used in the marketplace. Therefore, the NCWM does not support amendments to include mandatory provisions in the UPR as these provisions would take the decision to go to metric unit pricing out of the hands of consumers and retailers. Finally, the NCWM does not want to include any requirement that may discourage retailers from voluntarily providing unit price information.

(Amended 1997)

**The National Conference on Weights and Measures (NCWM) is supported by the National Institute of Standards and Technology (NIST) in partial implementation of its statutory responsibility for “cooperation with the states in securing uniformity in weights and measures laws and methods of inspection.”*

2. Status of Promulgation

The table beginning on page 10 shows the status of adoption of the Uniform Unit Pricing Regulation.

MARKUP COPY

Uniform Unit Pricing Regulation

Section 1. Application

Except for random and uniform weight packages that clearly state the unit price in accordance with existing regulations, any retail establishment providing unit price information for packaged commodities shall provide the unit price information in the manner prescribed herein.

Section 2. Terms for Unit Pricing

The declaration of the unit price of a particular commodity in all package sizes offered for sale in a retail establishment shall be uniformly and consistently expressed in terms of:

- (a) Price per kilogram or 100 g, or price per pound or ounce, if the net quantity of contents of the commodity is in terms of weight.
- (b) Price per liter or 100 mL, or price per dry quart or dry pint, if the net quantity of contents of the commodity is in terms of dry measure or volume.
- (c) Price per liter or 100 mL, or price per gallon, quart, pint, or fluid ounce, if the net quantity of contents of the commodity is in terms of liquid volume.
- (d) Price per individual unit or multiple units if the net quantity of contents of the commodity is in terms of count.
- (e) Price per square meter, square decimeter, or square centimeter, or price per square yard, square foot, or square inch, if the net quantity of contents of the commodity is in terms of area.

Section 3. Exemptions

- (a) Small Packages. – Commodities shall be exempt from these provisions when packaged in quantities of less than 28 g (1 oz) or 29 mL (1 fl oz) or when the total retail price is 50 cents or less.
- (b) Single Items. – Commodities shall be exempt from these provisions when only one brand in only one size is offered for sale in a particular retail establishment.
- (c) Infant Formula. – For “infant formula,” unit price information may be based on the reconstituted volume. “Infant formula” means a food that is represented for special dietary use solely as a food for infants by reason of its simulation of human milk or suitability as a complete or partial substitute for human milk.
- (d) Variety and Combination Packages. – Variety and Combination Packages as defined in Section 2.9 and Section 2.10 in the Uniform Packaging and Labeling Regulation ^[NOTE 1, page 143] shall be exempt from these provisions.

NOTE 1: See “Uniform Packaging and Labeling Regulation.”

Section 4. Pricing

- (a) The unit price shall be to the nearest cent when a dollar or more.
- (b) If the unit price is under a dollar, it shall be listed:
 - (1) to the tenth of a cent; or

(2) to the whole cent.

The retail establishment shall have the option of using (b)(1) or (b)(2), but shall not implement both methods.

The retail establishment shall accurately and consistently use the same method of rounding up or down to compute the price to the whole cent.

Section 5. Presentation of Price

- (a) In any retail establishment in which the unit price information is provided in accordance with the provisions of this regulation, that information may be displayed by means of a sign that offers the unit price for one or more brands and/or sizes of a given commodity, by means of a sticker, stamp, sign, label, or tag affixed to the shelf upon which the commodity is displayed, or by means of a sticker, stamp, sign, label, or tag affixed to the consumer commodity.
- (b) Where a sign providing unit price information for one or more sizes or brands of a given commodity is used, that sign shall be displayed clearly and in a non-deceptive manner in a central location as close as practical to all items to which the sign refers.
- (c) If a single sign or tag includes the unit price information for more than one brand or size of a given commodity, the following information shall be provided:
 - (1) the identity and the brand name of the commodity;
 - (2) the quantity of the packaged commodity, if more than one package size per brand is displayed;
 - (3) the total retail sales price; and
 - (4) the price per appropriate unit, in accordance with Section 2. Terms for Unit Pricing.

Section 6. Uniformity

- (a) If different brands or package sizes of the same consumer commodity are expressed in more than one unit of measure (e.g., soft drinks are offered for sale in 2 L bottles and 12 fl oz cans), the retail establishment shall unit price the items consistently.
- (b) When metric units appear on the consumer commodity in addition to other units of measure, the retail establishment may include both units of measure on any stamps, tags, labels, signs, or lists.

Section 7. Effective Date

This regulation shall become effective on August 1, ~~2013~~2014.

(Amended 1997)

D. Uniform Regulation for the Voluntary Registration of Servicepersons and Service Agencies for Commercial Weighing and Measuring Devices

as adopted by
The National Conference on Weights and Measures*

1. Background

The Uniform Regulation covering the registration of servicepersons and service agencies was developed and adopted by the National Conference on Weights and Measures (NCWM) in 1966, retitled in 1983, and substantially revised in 1984. It is designed to promote uniformity among those jurisdictions that provide for or are contemplating the establishment of some type of control over the servicing of commercial weighing and measuring devices. It offers to a serviceperson or to a service agency the opportunity to register and carries with it the privilege of restoring devices to service and of placing new or used devices in service.

Two unique features of the registration plan are its voluntary nature and the provision for reciprocity. Registration is not required; however, the privileges gained make it attractive. Also, in order to provide maximum effectiveness of the program and to reduce legal obstacles to a minimum to service across state lines, provision is made for reciprocity in certification of standards and testing equipment among states.

2. Status of Promulgation

The table beginning on page 10 shows the status of adoption of the Uniform Regulation for the Voluntary Registration of Servicepersons and Service Agencies for Commercial Weighing and Measuring Devices.

**The National Conference on Weights and Measures (NCWM) is supported by the National Institute of Standards and Technology (NIST) in partial implementation of its statutory responsibility for “cooperation with the states in securing uniformity in weights and measures laws and methods of inspection.”*

THIS PAGE INTENTIONALLY LEFT BLANK

MARKUP COPY

Uniform Regulation for the Voluntary Registration of Servicepersons and Service Agencies for Commercial Weighing and Measuring Devices

Section 1. Policy

For the benefit of the users, manufacturers, and distributors of commercial weighing and measuring devices, it shall be the policy of the Director of Weights and Measures, hereinafter referred to as “Director,” to accept registration of (a) an individual and (b) an agency providing acceptable evidence that he, she, or it is fully qualified by training or experience to install, service, repair, or recondition a commercial weighing or measuring device; has a thorough working knowledge of all appropriate weights and measures laws, orders, rules, and regulations; and has possession of, or has available for use, and will use suitable and calibrated weights and measures field standards and testing equipment appropriate in design and adequate in amount. (An employee of the government shall not be eligible for registration.)

The Director will check the qualifications of each applicant. It will be necessary for an applicant to have available sufficient field standards and equipment (see Section 5, Minimum Equipment).

It shall also be the policy of the Department to issue a “Certificate of Registration” to qualified applicants whose applications for registration are approved. This Certificate grants authority to remove rejection seals and tags placed on Commercial and Law Enforcement Weighing and Measuring Devices by authorized weights and measures officials, to place in service repaired devices that were rejected, and to place in service devices that have been newly installed.

The Director is NOT guaranteeing the work or fair dealing of a Registered Serviceperson or Service Agency. He will, however, remove from the registration list any Registered Serviceperson or Service Agency that performs unsatisfactory work or takes unfair advantage of a device owner.

Registration with the Director shall be on a voluntary basis. The Director shall reserve the right to limit or reject the application of any Serviceperson or Service Agency and to revoke his, her, or its permit to remove rejection seals or tags for good cause.

This policy shall in no way preclude or limit the right and privilege of any individual or agency not registered with the Director to install, service, repair, or recondition a commercial weighing or measuring device (see Section 7, Privileges and Responsibilities of a Voluntary Registrant).

(Added 1966) (Amended 1984 and 2005)

Section 2. Definitions

2.1. Registered Serviceperson. – Any individual who for hire, award, commission, or any other payment of any kind, installs, services, repairs, or reconditions a commercial weighing or measuring device, and who voluntarily registers with the Director of Weights and Measures.

(Added 1966)

2.2. Registered Service Agency. – Any agency, firm, company, or corporation that for hire, award, commission, or any other payment of any kind installs, services, repairs, or reconditions a commercial weighing or measuring device, and that voluntarily registers with the Director of Weights and Measures. Under agency registration, identification of individual servicepersons shall be required.

(Added 1966) (Amended 1984)

2.3. Commercial and Law Enforcement Weighing and Measuring Devices. – Any weight or measure or weighing or measuring device commercially used or employed in establishing the size, quantity, extent, area, or measurement of quantities, things, produce, or articles for distribution or consumption, purchased, offered, or

submitted for sale, hire, or award, or in computing any basic charge or payment for services rendered on the basis of weight or measure. It shall also include any accessory attached to or used in connection with a commercial weighing or measuring device when such accessory is so designed or installed that its operation affects the accuracy of the device. It also includes weighing and measuring equipment in official use for the enforcement of law or for the collection of statistical information by government agencies.

(Added 1966) (Amended 1984)

Section 3. Registration Fee

There shall be charged by the Director an annual fee of \$Zero per Registered Serviceperson and \$Zero per Registered Service Agency to cover costs at the time application for registration is made, and annually, thereafter.

(Added 1966) (Amended 1984)

Section 4. Voluntary Registration

An individual or agency qualified by training or experience may apply for registration to service weighing devices or measuring devices on an application form supplied by the Director. Said form, duly signed and witnessed, shall include certification by the applicant that the individual or agency is fully qualified to install, service, repair, or recondition whatever devices for the service of which competence is being registered; has in possession or available for use, and will use, all necessary testing equipment and standards; and has full knowledge of all appropriate weights and measures laws, orders, rules, and regulations. An applicant also shall submit appropriate evidence or references as to qualifications. Application for registration shall be voluntary, but the Director is authorized to reject or limit any application.

(Added 1966) (Amended 1984)

Section 5. Minimum Equipment

Applicants must have available sufficient standards and equipment to adequately test devices as set forth in the Notes section of each applicable code in NIST Handbook 44, “Specifications, Tolerances, and Other Technical Requirements for Weighing and Measuring Devices.” This equipment will meet the specifications of NIST 105-series standards (or other suitable and designated standards). This section shall not preclude the use of additional field standards and/or equipment, as approved by the Director, for uniform evaluation of device performance (see Section 9, Examination and Calibration or Certification of Standards and Testing Equipment).

(Added 1984) (Amended 2005)

Section 6. Certificate of Registration

The Director will review and check the qualifications of each applicant. The Director shall issue to the applicant a “Certificate of Registration,” including an assigned registration number if it is determined that the applicant is qualified. The “Certificate of Registration” will expire 1 year from the date of issuance.

(Added 1966) (Amended 1984)

Section 7. Privileges and Responsibilities of a Voluntary Registrant

A bearer of a Certificate of Registration shall have the authority to remove an official rejection tag or mark placed on a weighing or measuring device by the authority of the Director; place in service, until such time as an official examination can be made, a weighing or measuring device that has been officially rejected; and place in service, until such time as an official examination can be made, a new or used weighing or measuring device. The registered serviceperson or service agency is responsible for installing, repairing, and adjusting devices such that the devices are adjusted as closely as practicable to zero error.

(Added 1966) (Amended 1984)

Section 8. Placed in Service Report

The Director shall furnish each registered serviceperson and registered service agency with a supply of report forms to be known as “Placed in Service Reports.” Such a form shall be executed in triplicate, shall include the assigned registration number, and shall be signed by a registered serviceperson or by a serviceperson representing a registered agency for each rejected device restored to service and for each newly installed device placed in service. Within 24 hours after a device is restored to service or placed in service, the original of the properly executed Placed in Service Report, together with any official rejection tag removed from the device, shall be forwarded to the Director at 4608 W. 61st Little Rock, Arkansas. The duplicate copy of the report shall be handed to the owner or operator of the device, and the triplicate copy of the report shall be retained by the Registered Serviceperson or Registered Service Agency.

(Added 1966) (Amended 2005)

Section 9. Examination and Calibration or Certification of Standards and Testing Equipment

All field standards that are used for servicing and testing weights and measures devices for which competence is registered shall be submitted to the Director for initial and subsequent verification and calibration at intervals determined by the Director. A registered serviceperson or registered service agency shall not use in servicing commercial weighing or measuring devices any field standards or testing equipment that have not been calibrated or verified by the Director. In lieu of submission of physical standards, the Director may accept calibration and/or verification reports from any laboratory that is formally accredited or recognized. The Director shall maintain a list of organizations from which the state will accept calibration reports. The state shall retain the right to periodically monitor calibration results and/or to verify field standard compliance to specifications and tolerances when field standards are initially placed into service or at any intermediate point between calibrations.

(Added 1966) (Amended 1984, 1999, and 2005)

Section 10. Revocation of Certificate of Registration

The Director is authorized to suspend or revoke a Certificate of Registration for good cause which shall include, but not be limited to: taking of unfair advantage of an owner of a device; failure to have test equipment or standards certified; failure to use adequate testing equipment; or failure to adjust commercial or law enforcement devices to comply with Handbook 44 subsequent to service or repair.

(Added 1966) (Amended 1984)

Section 11. Publication of Lists of Registered Servicepersons and Registered Service Agencies

The Director shall publish, from time to time as he deems appropriate, and may supply upon request, lists of Registered Servicepersons and Registered Service Agencies.

(Added 1966)

Section 12. Effective Date

This regulation shall become effective on August 1, ~~2013~~2014.

(Added 1966)

THIS PAGE INTENTIONALLY LEFT BLANK

MARKUP COPY

E. Uniform Open Dating Regulation

as adopted by
The National Conference on Weights and Measures*

1. Background

Numerous state and local jurisdictions have provided for, or are considering, mandatory open dating of certain packaged commodities. Additionally, many commodities in the marketplace are now voluntarily open dated. Lack of uniformity between jurisdictions could impede the orderly flow of commerce.

In 1985, the National Conference on Weights and Measures (NCWM), in concert with the Association of Food and Drug Officials, wrote a new Uniform Regulation. It resolved the differences in the versions developed independently by the two organizations.

The regulation provides two options for implementation by the states. One requires open dating on all perishable foods and the other permits voluntary open dating of such foods. In the latter (voluntary) case, the open dating must then conform to the uniform regulation. Notes to Sections 1.1. Purpose and 3.1. “Sell By” Date indicate the alternate wording for the voluntary version of the Regulation.

2. Status of Promulgation

The table beginning on page 10 shows the status of adoption of the Uniform Open Dating Regulation.

**The National Conference on Weights and Measures (NCWM) is supported by the National Institute of Standards and Technology (NIST) in partial implementation of its statutory responsibility for “cooperation with the states in securing uniformity in weights and measures laws and methods of inspection.”*

THIS PAGE INTENTIONALLY LEFT BLANK

MARKUP COPY

Uniform Open Dating Regulation ^[NOTE 1, page 157]

Section 1. Purpose, Scope, and Application

1.1. Purpose. ^[NOTE 1, page 157] – The purpose of this regulation is to prescribe mandatory uniform date labeling of prepackaged, perishable foods and to prescribe optional uniform date labeling that must be used whenever a packager elects to use date labeling on prepackaged foods that are not perishable. Open dating is intended for use and understanding by both distributors and consumers when judging food qualities.

NOTE 1: Alternatively, this regulation may be adopted to require uniformity of open dating of perishable foods whenever a packager voluntarily elects to use date labeling. In such instances Sections 1.1. Purpose and 3.1. “Sell By” Date are reworded in the following manner:

1.1. Purpose. – The purpose of this regulation is to prescribe uniform date labeling that must be used whenever a packager elects to use date labeling on a prepackaged food. Open date labeling is intended for use and understanding by both distributors and consumers when judging food qualities.

3.1. “Sell By” Date. – If a retail food establishment elects to sell or offer for sale a prepackaged perishable food identified with a “sell by” date, the “sell by” date used must be as prescribed by this regulation.

1.2. Scope and Application. – This regulation prescribes the manner of date labeling, the method of determining the appropriate date, required records, responsible persons, and the foods subject to this regulation. This regulation provides for the permissible sale of a regulated food after the expiration of the date on the label. This regulation does not apply to any food that is not prepackaged or is exempted by Section 8.

Section 2. Definitions

2.1. “Sell By” Date. – A recommended last date of sale that permits a subsequent period before deterioration of qualities described in 2.2. Perishable Food, 2.3. Semi Perishable Food, and 2.4. Long Shelf Life Food.

2.2. Perishable Food. – Any food having a significant risk of spoilage, loss of value, or loss of palatability within 60 days of the date of packaging.

2.3. Semi Perishable Food. – Any food for which a significant risk of spoilage, loss of value, or loss of palatability occurs only after a minimum of 60 days, but within 6 months, after the date of packaging.

2.4. Long Shelf Life Food. – Any food for which a significant risk of spoilage, loss of value, or loss of palatability does not occur sooner than 6 months after the date of packaging, including foods preserved by freezing, dehydrating, or being placed in a hermetically sealed container.

2.5. Prepackaged. – Food packaged prior to being displayed or offered for retail sale.

2.6. “Best If Used By” Date. – A date prior to deterioration of qualities described in 2.3. Semi Perishable Food and 2.4. Long Shelf Life Food.

2.7. Person. – An individual, partnership, association, or corporation.

Section 3. Sale of Perishable Food and Date Determination

3.1. “Sell By” Date. ^[NOTE 1, page 157] – A retail food establishment shall not sell or offer for sale a prepackaged perishable food unless it is identified with a “sell by” date as prescribed by this regulation.

3.2. Sale After Expiration of “Sell By” Date.

3.2.1. Advertisement. – Perishable food shall not be offered for sale after the “sell by” date unless it is wholesome and advertised in a conspicuous manner as being offered for sale after the recommended last date of sale. The placement of a sign, sticker, or tag is acceptable for such advertising if it is easily readable and clearly identifies the perishable food as having passed the recommended last date of sale.

3.2.2. Responsibility for Advertisement. – The retailer or final seller is responsible for the advertisement, described in Section 3.2.1. Advertisement, of a perishable food offered for sale after the recommended last date of sale.

3.3. Determination of “Sell By” Date.

3.3.1. Reasonable Period for Consumption. – A manufacturer, processor, packer, re-packer, retailer, or other person who prepackages perishable food, shall determine a date that allows a reasonable period after sale for consumption of the food without physical spoilage, loss of value, or loss of palatability. A reasonable period for consumption shall consist of at least one third of the approximate total shelf life of the perishable food.

3.3.2. Responsibility for “Sell By” Date. – A retailer who purchases prepackaged perishable food may upon written agreement with the person prepackaging such food determine, identify, and be responsible for the “sell by” date placed on or attached to each package of such food.

3.4. Manner of Expressing Date.

3.4.1. Month and Day, or Day of Week. – A person described in Section 3.3.1. Reasonable Period for Consumption or 3.3.2. Responsibility for “Sell By” Date shall place or attach to each package of perishable food a date by month and day. However, bakery products with a shelf life of not more than seven days may be dated with the day of the week representing the last recommended day of sale.

3.4.2. The term “Sell By”. – The “sell by” date shall be displayed with the term “sell by” or words of similar import immediately preceding or immediately over the designated date unless a prominent notice is on the label describing the date as a “sell by” date and indicating the location of the date.

3.4.3. Abbreviation of Weekday. – If the day of the week is solely designated as provided in Section 3.4.1. Month and Day, or Day of Week the name of the day may be abbreviated by the use of either the first two or first three letters of the name of the day.

3.4.4. Expression of Month and Day. – Except as provided for in Section 3.4.1. Month and Day, or Day of Week the date shall be designated by:

- (a) the first three letters of the month, preceded or followed by a numeral indicating the calendar day; or
- (b) the month represented numerically followed by a numeral designation of the calendar day.

The month and day designation shall be separated by a period, slash, dash, or spacing. When a numeral designation of the first nine days of the month is used, the number shall include a zero as the first digit; for example, 01 or 03.

(Amended 1987)

3.4.5. Expression of the Year. – The “sell by” date may include the year following the day if such year is expressed as a two or four digit number separated as described in Section 3.4.4. Expression of Month and Day.

Section 4. Sale of Semi Perishable and Long Shelf Life Food

4.1. “Best If Used By” Date. – A manufacturer, processor, packer, re-packer, or other person who prepackages semi perishable or long shelf life food may place upon or attach to the package an open date providing it is designated by the “best if used by” date.

4.2. Sale After Expiration of “Best If Used By” Date. – A retail food establishment may sell or offer for sale food beyond the designated “best if used by” date provided the food is wholesome and the sensory physical quality standards for that food have not significantly diminished.

4.3. Manner of Expressing Date. – The “best if used by” date as required by Section 4.1. “Best If Used By” Date shall be placed upon or attached to each container or package and be limited to the terms “best if used by” or words of similar import followed by or immediately over the date designated by the month and year unless a prominent notice is on the label describing the date as a “best if used by” date and indicating the location of the date. The date shall be designated by the first three letters of the month followed by a numeral indicating the year. The use of the day of the month is permissible provided that the day of the month is placed prior to the month; for example, 30 Jun 81.

Section 5. Placement of the Date

The date, whether “sell by” or “best if used by,” shall be printed, stamped, embossed, perforated, or otherwise shown on the package, label on the package, or tag attached to the package in a manner that is easily readable and separate from other information, graphics, or lettering so as to be clearly visible to a prospective purchaser. The date shall not be superimposed on other required information or obscured by other information, graphics, or pricing. Regardless of the type size used, the date shall be easily readable. These requirements do not preclude a supplemental notice elsewhere on a package describing and/or indicating the location of the date.

Section 6. Factors for the Date Determination

A person who, as provided for in this regulation, places either the “sell by” date or “best if used by” date on a package shall determine the date by taking into consideration the food quality, characteristics, formulation, processing impact, packaging or container and other protective wrapping or coating, customary transportation, and storage and display conditions. For purposes of calculating this date, home storage conditions shall be considered to be similar to those in the usual retail store except that the date for refrigerated food may be calculated by using a home storage temperature standard of 40 °F (4.4 °C).

Section 7. Records

A person who is responsible for establishing the date for perishable, semi perishable, and long shelf life food shall keep a record of the method used to determine the date. A record revision is necessary whenever a factor affecting date determination is altered. Such record shall be retained for not less than six months after the most recent “sell by” or “best if used by” date and shall be available during normal business hours for examination upon request by Arkansas State Plant Board.

Section 8. Exemptions

8.1. This regulation does not apply to perishable fruits or vegetables in a container permitting sensory examination.

8.2. This regulation does not apply to prepackaged perishable foods open dated according to requirements of federal law or regulation.

Section 9. Preemption of Local, County, and Municipal Ordinance

A municipality or county shall not adopt or impose standards or requirements other than those provided for in this regulation.

Section 10. Effective Date

This regulation shall become effective on and after August 1, ~~2013~~2014.

MARKUP COPY

F. Uniform Regulation for National Type Evaluation

as adopted by
The National Conference on Weights and Measures*

1. Background

The Uniform Regulation for National Type Evaluation was adopted by the NCWM at the 68th Annual Meeting in 1983 and is a necessary adjunct to recognize and enable participation in the National Type Evaluation Program administered by the National Conference on Weights and Measures (NCWM). The Regulation specifically authorizes: type evaluation; recognition of a NCWM “Certificate of Conformance” of type; the State Measurement Laboratory to operate as a Participating Laboratory, if authorized by the National Institute of Standards and Technology (NIST) under its program of recognition of State Measurement Laboratories; and, the state to charge fees to those persons who seek type evaluation of weighing and measuring devices.

(Amended 2000)

At the 81st Annual Meeting in 1996, the NCWM adopted major revisions to the Uniform Regulation for National Type Evaluation. These revisions were made to clarify the requirements and incorporate the policies and guidelines adopted by the Executive Committee as published in NCWM Publication 14, “Technical Policy, Checklists, and Test Procedures.”

(Amended 1997)

2. Intent

It is the intent of this regulation to have all states use the National Type Evaluation, as approved by the NCWM, as their examining procedure. If a state does not wish to establish a Participating Laboratory, Section 2.4. Participating Laboratory and Section 4. Participating Laboratory may be deleted.

3. Status of Promulgation

The table beginning on page 10 shows the status of adoption of the Uniform Regulation for National Type Evaluation.

**The National Conference on Weights and Measures (NCWM) is supported by the National Institute of Standards and Technology in partial implementation of its statutory responsibility for “cooperation with the states in securing uniformity in weights and measures laws and methods of inspection.”*

THIS PAGE INTENTIONALLY LEFT BLANK

MARKUP COPY

Uniform Regulation for National Type Evaluation

Section 1. Application

This regulation shall apply to ^[NOTE 1, page 165] any type of device and/or equipment covered in National Institute of Standards and Technology (NIST) Handbook 44 for which evaluation procedures have been published in the National Conference on Weights and Measures (NCWM), Publication 14, “National Type Evaluation Program, Technical Policy, Checklists, and Test Procedures.”

NOTE 1: This section can be amended to include a list of devices or device types to which NTEP evaluation criteria does not apply. Additionally, a state can amend this section to allow it to conduct a type evaluation and issue a “Certificate of Approval.” This approach should be limited to occasions where formal NTEP Type Evaluation criteria does not apply and to new technologies or device applications where the development of criteria is deemed necessary by the Director.

Section 2. Definitions

2.1. Active Certificate of Conformance (CC). – A document issued based on testing by a Participating Laboratory, which the certificate holder maintains in active status under the National Type Evaluation Program (NTEP). The document constitutes evidence of conformance of a type with the requirements of this document, NIST Handbook 44, “Specifications, Tolerances, and Other Technical Requirements for Weighing and Measuring Devices,” and the test procedures contained in NCWM Publication 14. By maintaining the Certificate in active status, the Certificate holder declares the intent to continue to manufacture or remanufacture the device consistent with the type and in conformance with the applicable requirements. A device is traceable to an active CC if: (a) it is of the same type identified on the Certificate, and (b) it was manufactured during the period that the Certificate was maintained in active status. For manufacturers of grain moisture meters, maintenance of active status also involves annual participation in the NTEP Laboratory On-going Calibration Program, OCP (Phase II).

(Amended 2000, 2001, and 2004)

2.2. Device. – A piece of commercial or law enforcement equipment as defined in Section 2.15. Commercial and Law Enforcement Equipment. A device may be a single unit or a combination of separate and compatible main elements. A device shall include, at a minimum, those main elements that: (a) perform the measurement, and (b) process the measurement signals up to the first indicated or recorded value of the final quantity upon which the transaction is based.

(Amended 2004)

2.3. Director. – Means the Director of the Arkansas State Plant Board.

2.4. Manufactured Device. – Any commercial weighing or measuring device shipped as new from the original equipment manufacturer.

(Added 2001)

2.5. National Type Evaluation Program. – A program of cooperation between the NCWM, NIST, other federal agencies, the states, and the private sector for determining, on a uniform basis, conformance of a type with the relevant provisions of National Institute of Standards and Technology Handbook 44, “Specifications, Tolerances, and Other Technical Requirements for Weighing and Measuring Devices,” and NCWM, Publication 14, “National Type Evaluation Program, Technical Policy, Checklists, and Test Procedures.”

(Amended 2000)

2.6. One-of-a-Kind Device. – A (non-NTEP) device designed to meet unique demands for a specific installation and of a specific design which is not commercially available elsewhere (one such device per manufacturer). If a device manufactured for sale by a company has been categorized and tested as a “one-of-a-kind” device and the manufacturer then decides to manufacture an additional device or devices of that same type, the device will no

longer be considered a “one-of-a-kind.” This also applies to a device that has been determined to be a “one-of-a-kind” device by a weights and measures jurisdiction in one state and the manufacturer decides to manufacture and install another device of that same type in another state. In this case, the manufacturer of the device must request an NTEP evaluation on the device through the normal application process unless NTEP has already deemed that such evaluation will not be conducted.

(Amended 1998)

2.7. Participating Laboratory. – Any State Measurement Laboratory or State Weights and Measures Agency or other laboratory that has been authorized to conduct a type evaluation under the NTEP.

(Amended 2001)

2.8. Person. – The term “person” means both singular and plural, as the case demands, and includes individuals, partnerships, corporations, companies, societies, and associations.

2.9. Remanufactured Device. – A device that is disassembled, checked for wear, parts replaced or fixed, reassembled, and made to operate like a new device of the same type.

(Amended 2001)

2.10. Remanufactured Element. – An element that is disassembled, checked for wear, parts replaced or fixed, reassembled, and made to operate like a new element of the same type.

(Added 2001)

2.11. Repaired Device. – A device on which work is performed that brings the device back into proper operating condition.

(Amended 2001)

2.12. Repaired Element. – An element on which work is performed that brings the element back into proper operating condition.

(Added 2001)

2.13. Type. – A model or models of a particular device, measurement system, instrument, or element that positively identifies the design. A specific type may vary in its measurement ranges, size, performance, and operating characteristics as specified in the CC.

2.14. Type Evaluation. – The testing, examination, and/or evaluation of a type by a Participating Laboratory under the NTEP.

2.15. Commercial and Law Enforcement Equipment.

- (a) Weighing and measuring equipment commercially used or employed in establishing the size, quantity, extent, area, or measurement of quantities, things, produce, or articles for distribution or consumption, purchased, offered, or submitted for sale, hire, or award, or in computing any basic charge or payment for services rendered on the basis of weight or measure.
- (b) Any accessory attached to or used in connection with a commercial weighing or measuring device when such accessory is so designed that its operation affects the accuracy of the device.
- (c) Weighing and measuring equipment in official use for the enforcement of law or for the collection of statistical information by government agencies. ^[NOTE 2, page 166]

NOTE 2: *The section is identical to G-A.1. Commercial and Law Enforcement Equipment, Section 1.10. General Code, National Institute of Standards and Technology Handbook 44 for definition of “commercial” and “law enforcement equipment.”*

Section 3. Certificate of Conformance (CC)

The Director shall require a device to be traceable to an active Certificate of Conformance (CC) prior to its installation or use for commercial or law enforcement purposes. If the device consists of separate and compatible main elements, each main element shall be traceable to a CC. A device is traceable to a CC if:

- (c) it is of the same type identified on the Certificate; and
- (b) it was manufactured during the period that the Certificate was maintained in active status.

(Amended 2001 and 2004)

Section 4. Prohibited Acts and Exemptions

- (a) Except for a device exempted by this section, no person shall sell a device unless it is traceable to an active CC.
(Amended 2001)
- (b) Except for a device exempted by this section, no person shall use a device unless it is traceable to an active CC.
(Amended 2001)
- (c) A device in service in this State prior to July 11, 2002 that meets the specifications, tolerances, and other technical requirements of National Institute of Standards and Technology Handbook 44 shall not be required to be traceable to an active CC.
(Amended 2001)
- (d) A device in service in this State prior to July 11, 2002 removed from service by the owner or on which the department has issued a removal order after July 11, 2002 and returned to service at a later date shall be modified to meet all specifications, tolerances, and other technical requirements of National Institute of Standards and Technology Handbook 44 effective on the date of the return to service. Such a device shall not be required to be traceable to an active CC.
(Amended 2001)
- (e) A device in service in this State prior to July 11, 2002 which is repaired after such date shall meet the specifications, tolerances, and other technical requirements of National Institute of Standards and Technology Handbook 44 and shall not be required to be traceable to an active CC.
(Amended 2001)
- (f) A device in service in this State prior to July 11, 2002 that is still in use may be installed at another location in this state provided the device meets requirements in effect as of the date of installation in the new location; however, the device shall not be required to be traceable to an active CC.
(Amended 2001)
- (g) A device in service in another State prior to July 11, 2002 may be installed in this State; however, the device shall meet the specifications, tolerances, and technical requirements for weighing and measuring devices in National Institute of Standards and Technology Handbook 44 and be traceable to an active CC.
(Amended 2001)
- (h) **One-of-a-kind Device.** – The Director may accept the design of a one-of-a-kind device without an NTEP evaluation pending inspection and performance testing to satisfy that the device complies with Handbook 44 and is capable of performing within the Handbook 44 requirements for a reasonable period of time under normal conditions of use. Indicators and load cells in all “one-of-a-kind” scale installations

must have an active NTEP CC as evidence that the system meets the influence factor requirements of Handbook 44.

(Amended 1998 and 2001)

- (i) **Repaired Device.** – If a person makes changes to a device to the extent that the metrological characteristics are changed, that specific device is no longer traceable to the active CC.
(Amended 2001)
- (j) **Remanufactured Device.** – If a person repairs or remanufactures a device, they are obligated to repair or remanufacture it consistent with the manufacturer’s original design; otherwise, that specific device is no longer traceable to an active CC.
(Amended 2001)
- (k) **Copy of a Device.** – The manufacturer who copies the design of a device that is traceable to an active CC, but which is made by another company, must obtain a separate CC for the device. The CC for the original device shall not apply to the copy.
- (l) **Device Components.** – If a person buys a load cell(s) and an indicating element that are traceable to CCs and then manufactures a device from the parts, that person shall obtain an active CC for the device.
(Amended 2001)

Section 5. Participating Laboratory and Agreements

The Director is authorized to:

- (a) Operate a Participating Laboratory as part of the NTEP. In this regard, the Director is authorized to charge and collect fees for type evaluation services.
- (b) Cooperate with and enter into agreements with any person in order to carry out the purposes of the act.

Section 6. Revocation of Conflicting Regulations

All provisions of all orders and regulations before issued on this same subject that are contrary to or inconsistent with the provisions of this regulation, are hereby revoked.

(Amended 2001)

Section 7. Effective Date

This regulation shall become effective on April 1, ~~2013~~2014.

(Amended 2001)

G. Uniform Engine Fuels and Automotive Lubricants Regulation

as adopted by
The National Conference on Weights and Measures*

1. Background

In 1984, the National Conference on Weights and Measures (NCWM) adopted a Section 2.20. in the Uniform Regulation for the Method of Sale of Commodities requiring that motor fuels containing alcohol be labeled to disclose to the retail purchaser that the fuel contains alcohol. The delegates deemed this action necessary since motor vehicle manufacturers were qualifying their warranties with respect to some gasoline-alcohol blends, motor fuel users were complaining to weights and measures officials about fuel quality and vehicle performance, and ASTM International (ASTM) had not yet finalized quality standards for oxygenated (which includes alcohol-containing) fuels. While a few officials argued weights and measures officials should not cross the line from quantity assurance programs to programs regulating quality, the delegates were persuaded that the issue needed immediate attention.

A Motor Fuels Task Force was appointed in 1984 to develop mechanisms for achieving uniformity in the evaluation and regulation of motor fuels. The Task Force developed the Uniform Motor Fuel Inspection Law (see the Uniform Engine Fuels and Automotive Lubricants Inspection Law section of this handbook) and the Uniform Engine Fuel and Automotive Lubricants Regulation to accompany the law. The Uniform Law required registration and certification of motor fuel as meeting ASTM standards. The regulation defined the ASTM standards to be applied to motor fuel.

In 1992, the NCWM established the Petroleum Subcommittee under the Laws and Regulations Committee. The subcommittee recommended major revisions to the Regulation that was adopted at the 80th NCWM in 1995. The scope of the regulation was expanded to include all engine fuels, petroleum products, and automotive lubricants; its title was changed accordingly; and the fuel specifications and method of sale sections were revised to address the additional products. Other changes included expansion of the definitions section and addition of sections on retail storage tanks, condemned product, registration of engine fuels designed for special use, and test methods and reproducibility limits.

In 2007, the Petroleum Subcommittee (now referred to as the Fuels and Lubricants Subcommittee) undertook a review of this regulation to update it by eliminating reference to “petroleum products” and to reflect the addition of new engine fuels to the marketplace.

At the 2008 NCWM Interim Meeting, the Laws and Regulations Committee changed the Petroleum Subcommittee’s name to the Fuels and Lubricants Subcommittee (FALS) in recognition of its work with a wide variety of fuels including petroleum and biofuels.

2. Status of Promulgation

The Uniform Regulation for Engine Fuels and Automotive Lubricants was adopted by the NCWM in 1995 and the latest amendments were adopted in 2008. The status of state actions with respect to this Regulation is shown in the table beginning on page 10.

(Amended 2008)

**The National Conference on Weights and Measures (NCWM) is supported by the National Institute of Standards and Technology (NIST) in partial implementation of its statutory responsibility for “cooperation with the states in securing uniformity in weights and measures laws and methods of inspection.”*

THIS PAGE INTENTIONALLY LEFT BLANK

MARKUP COPY

Uniform Engine Fuels and Automotive Lubricants Regulation

Section 1. Definitions

1.1. ASTM International. (www.astm.org) – The international voluntary consensus standards organization formed for the development of standards on characteristics and performance of materials, products, systems, and services, and the promotion of related knowledge.

1.2. Antiknock Index (AKI). – The arithmetic average of the Research Octane Number (RON) and Motor Octane Number (MON): $AKI = (RON+MON)/2$. This value is called by a variety of names, in addition to antiknock index, including: octane rating, posted octane, (R+M)/2 octane.

1.3. Automatic Transmission Fluid. – A product intended for use in a passenger vehicle, other than a bus, as either lubricant, coolant, or liquid medium in any type of fluid automatic transmission that contains a torque converter. For the purposes of this regulation, fluids intended for use in continuously variable transmissions are not considered “Automatic Transmission Fluid.”

(Added 2004)

1.4. Automotive Fuel Rating. – The automotive fuel rating required under the amended Octane Certification and Posting Rule (or as amended, the Fuel Rating Rule), 16 CFR Part 306. Under this Rule, sellers of liquid automotive fuels, including alternative fuels, must determine, certify, and post an appropriate automotive fuel rating. The automotive fuel rating for gasoline is the antiknock index (octane rating). The automotive fuel rating for alternative liquid fuels consists of the common name of the fuel, along with a disclosure of the amount, expressed as a minimum volume percent of the principal component of the fuel. For alternative liquid automotive fuels, a disclosure of other components, expressed as a minimum volume percent, may be included, if desired.

1.5. Automotive Gasoline, Automotive Gasoline-Oxygenate Blend. – A type of fuel suitable for use in spark ignition automobile engines and also commonly used in marine and non-automotive applications.

1.6. Aviation Gasoline. – A type of gasoline suitable for use as a fuel in an aviation spark-ignition internal combustion engine.

1.7. Aviation Turbine Fuel. – A refined middle distillate suitable for use as a fuel in an aviation gas turbine internal combustion engine.

1.8. Base Gasoline. – All components other than ethanol in a blend of gasoline and ethanol.

1.9. Biodiesel. – A fuel comprised of mono-alkyl esters of long chain fatty acids derived from vegetable oils or animal fats, designated B100.

1.10. Biodiesel Blend. – A fuel comprised of a blend of biodiesel fuel with petroleum-based diesel fuel, designated BXX. In the abbreviation BXX, (e.g., B20) represents the volume percentage of biodiesel fuel in the blend.

1.11. Cetane Number. – A numerical measure of the ignition performance of a diesel fuel obtained by comparing it to reference fuels in a standardized engine test.

1.12. Compressed Natural Gas (CNG). – Natural gas which has been compressed and dispensed into fuel storage containers and is suitable for use as an engine fuel.

1.13. Denatured Fuel Ethanol. – “Ethanol” as defined in Section 1.20. Ethanol.

1.14. Diesel Fuel. – A refined middle distillate suitable for use as a fuel in a compression-ignition (diesel) internal combustion engine.

- 1.15. Distillate.** - Any product obtained by condensing the vapors given off by boiling petroleum or its products.
- 1.16. EPA.** – The United States Environmental Protection Agency (www.epa.gov).
- 1.17. E85 Fuel Ethanol.** – A blend of ethanol and hydrocarbons of which the ethanol portion is nominally 75 to 85 volume percent denatured fuel ethanol.
- 1.18. Engine Fuel.** – Any liquid or gaseous matter used for the generation of power in an internal combustion engine.
- 1.19. Engine Fuels Designed for Special Use.** – Engine fuels designated by the Director as requiring registration. These fuels normally do not have ASTM or other national consensus standards applying to their quality or usability; common special fuels are racing fuels and those intended for agricultural and other off-road applications.
- 1.20. Ethanol.** – Also known as “Denatured Fuel Ethanol,” means nominally anhydrous ethyl alcohol meeting ASTM D4806 standards. It is intended to be blended with gasoline for use as a fuel in a spark-ignition internal combustion engine. The denatured fuel ethanol is first made unfit for drinking by the addition of the Alcohol and Tobacco Tax and Trade Bureau (TTB), www.ttb.gov, approved substances before blending with gasoline.
- 1.21. Fuel Cell.** – An electrochemical energy conversion device in which fuel and an oxidant react to generate electricity without consumption, physically or chemically, of its electrodes or electrolytes.
(Added 2012)
- 1.22. Fuel Oil.** – Refined oil middle distillates, heavy distillates, or residues of refining, or blends of these, suitable for use as a fuel for heating or power generation, the classification of which shall be defined by ASTM D396.
- 1.23. Gasoline.** – A volatile mixture of liquid hydrocarbons generally containing small amounts of additives suitable for use as a fuel in a spark-ignition internal combustion engine.
- 1.24. Gasoline-Alcohol Blend.** – A fuel consisting primarily of gasoline and a substantial amount (more than 0.35 mass percent of oxygen, or more than 0.15 mass percent of oxygen if methanol is the only oxygenate) of one or more alcohols.
- 1.25. Gasoline Gallon Equivalent (GGE).** – Equivalent to 2.567 kg (5.660 lb) of natural gas.
- 1.26. Gasoline Liter Equivalent (GLE).** – Equivalent to 0.678 kg (1.495 lb) of natural gas.
- 1.27. Diesel Liter Equivalent (DLE).** – means 0.756 kg of natural gas.
(Added 2013)
- 1.28. Diesel Gallon Equivalent (DGE).** – means 2.821 kg (6.22 lb) of natural gas.
(Added 2013)
- 1.29. Gasoline-Oxygenate Blend.** – A fuel consisting primarily of gasoline along with a substantial amount (more than 0.35 mass percent of oxygen, or more than 0.15 mass percent of oxygen if methanol is the only oxygenate) of one or more oxygenates.
- 1.30. Gear Oil.** – An oil used to lubricate gears, axles, or some manual transmissions.
(Added 2004)
- 1.31. Hydrogen Fuel.** – A fuel composed of molecular hydrogen intended for consumption in a surface vehicle or electricity production device with an internal combustion engine or fuel cell.
(Added 2012)

1.32. Internal Combustion Engine. – A device used to generate power by converting chemical energy bound in the fuel via spark-ignition or compression ignition combustion into mechanical work to power a vehicle or other device.

(Added 2012)

1.33. Kerosene. – (or “Kerosine”) A refined middle distillate suitable for use as a fuel for heating or illuminating, the classification of which shall be defined by the latest version of ASTM D3699, “Standard Specification for Kerosene.”

1.34. Lead Substitute. – An EPA-registered gasoline additive suitable, when added in small amounts to fuel, to reduce or prevent exhaust valve recession (or seat wear) in automotive spark-ignition internal combustion engines designed to operate on leaded fuel.

1.35. Lead Substitute Engine Fuel. – For labeling purposes, a gasoline or gasoline-oxygenate blend that contains a “lead substitute”.

1.36. Leaded. – For labeling purposes, any gasoline or gasoline-oxygenate blend which contains more than 0.013 g of lead per liter (0.05 g lead per U.S. gal). NOTE: EPA defines leaded fuel as one which contains more than 0.0013 g of phosphorus per liter (0.005 g per U.S. gal), or any fuel to which lead or phosphorus is intentionally added.

1.37. Liquefied Natural Gas (LNG). – Natural gas that has been liquefied at -126.1°C (-259°F) and stored in insulated cryogenic tanks for use as an engine fuel.

1.38. Liquefied Petroleum Gas (LPG). – A mixture of normally gaseous hydrocarbons, predominantly propane, or butane, or both, that has been liquefied by compression or cooling, or both to facilitate storage, transport, and handling.

1.39. Low Temperature Operability. – A condition which allows the uninterrupted operation of a diesel engine through the continuous flow of fuel throughout its fuel delivery system at low temperatures. Fuels with adequate low temperature operability characteristics have the ability to avoid wax precipitation and clogging in fuel filters.

(Added 1998) (Amended 1999)

1.40. Lubricant. – Oil (See 1.44. below.).

(Added 2008)

1.41. Lubricity. – A qualitative term describing the ability of a fluid to affect friction between, and wear to, surfaces **al** in relative motion under load.

(Added 2003)

1.42. M85 Fuel Methanol. – A blend of methanol and hydrocarbons of which the methanol portion is nominally 70 to 85 volume percent.

1.43. Motor Octane Number. – A numerical indication of a spark-ignition engine fuel’s resistance to knock obtained by comparison with reference fuels in a standardized ASTM D2700, “Motor Method Engine Test.”

1.44. Motor Oil. – An oil that reduces friction and wear between the moving parts within a reciprocating internal combustion engine and also serves as a coolant. For the purposes of this regulation, “vehicle motor oil” refers to motor oil which is intended for use in light- to heavy-duty vehicles including cars, sport utility vehicles, vans, trucks, buses, and off-road farming and construction equipment. For the purposes of this regulation, “recreational motor oil” refers to motor oil which is intended for use in four-stroke cycle engines used in motorcycles, ATVs, and lawn and garden equipment. For the purposes of this regulation, motor oil also means engine oil.

(Added 2004)

1.45. MTBE. – Methyl tertiary-butyl ether.

(Added 2008)

1.46. Oil. – A motor oil, engine oil, and/or gear oil.

(Added 2004)

1.47. Oxygen Content of Gasoline. – The percentage of oxygen by mass contained in a gasoline.

1.48. Oxygenate. – An oxygen-containing, ashless, organic compound, such as an alcohol or ether, which can be used as a fuel or fuel supplement.

1.49. Reformulated Gasoline (RFG). – A gasoline or gasoline-oxygenate blend certified to meet the specifications and emission reduction requirements established by the Clean Air Act Amendments of 1990, as amended by the Energy Policy Act of 2005, required to be sold for use in automotive vehicles in extreme and severe ozone non-attainment areas and those areas which opt to require reformulated gasoline.

(Amended 2008)

1.50. Research Octane Number. – A numerical indication of a spark-ignition engine fuel's resistance to knock obtained by comparison with reference fuels in a standardized ASTM D2699, "Research Method Engine Test."

1.51. SAE (SAE International). – A technical organization for engineers, scientists, technicians, and others who cooperate closely in the engineering, design, manufacture, use, and maintainability of self-propelled vehicles.

1.52. Substantially Similar. – Refers to the EPA's "Substantially Similar" rule, Section 211 (f) (1) of the Clean Air Act [42 U.S.C. 7545 (f) (1)].

1.53. ThermStability. – The ability of a fuel to resist the thermal stress which is experienced by the fuel when exposed to high temperatures in a fuel delivery system. Such stress can lead to formation of insoluble gums or organic particulates. Insolubles (e.g., gums or organic particulates) can clog fuel filters and contribute to injector deposits.

(Added 1998) (Amended 1999)

1.54. Unleaded. – When used in conjunction with "engine fuel" or "gasoline" means any gasoline or gasoline-oxygenate blend to which no lead or phosphorus compounds have been intentionally added and which contains not more than 0.013 g of lead per liter (0.05 g lead per U.S. gallon) and not more than 0.0013 g of phosphorus per liter (0.005 g phosphorus per U.S. gallon).

1.55. Wholesale Purchaser Consumer. – Any person who is an ultimate gasoline consumer of fuel methanol, fuel ethanol, diesel fuel, biodiesel, fuel oil, kerosene, aviation turbine fuels, natural gas, compressed natural gas, or liquefied petroleum gas and who purchases or obtains the product from a supplier and receives delivery of that product into a storage tank.

(Added 1998) (Amended 1999)

Section 2. Standard Fuel Specifications

2.1. Gasoline and Gasoline-Oxygenate Blends.

2.1.1. Gasoline and Gasoline-Oxygenate Blends (as defined in this regulation). – Shall meet the latest version of ASTM D4814, "Standard Specification for Automotive Spark-Ignition Engine Fuel" except for the permissible offsets for ethanol blends as provided in Section 2.1.2. Gasoline-Ethanol Blends.

(Added 2009)

2.1.2. Gasoline-Ethanol Blends. – When gasoline is blended with ethanol, the ethanol shall meet the latest version of ASTM D4806, "Standard Specification for Denatured Fuel Ethanol for Blending with Gasolines for

Use as Automotive Spark-Ignition Engine Fuel,” and the blend shall meet the latest version of ASTM D4814, “Standard Specification for Automotive Spark-Ignition Engine Fuel,” with the following permissible exceptions:

- (a) The maximum vapor pressure shall not exceed the ASTM D4814 limits by more than:
 - (1) 1.0 psi for blends containing 9 to 10 volume percent ethanol from June 1 through September 15.
 - (2) 1.0 psi for blends containing one or more volume percent ethanol for volatility classes A, B, C, D from September 16 through May 31.
 - (3) 0.5 psi for blends containing one or more volume percent ethanol for volatility Class E from September 16 through May 31.

The vapor pressure exceptions in subsections 2.1.2. Gasoline-Ethanol Blends will remain in effect until May 1, 2016, or until ASTM incorporates changes to the vapor pressure maximums for ethanol blends, whichever occurs earlier.

~~NOTE 1: The value for the 50 volume percent evaporated point noted in Section 2.1.3.(b) and the values for Classes 1, 2, and 3 for the minimum temperature for a Vapor Liquid Ratio of 20 in Section 2.1.3.(c) are now aligned and identical to those that are being published in ASTM D4814-09b and apply equally to gasoline and gasoline ethanol blends. In future editions of NIST Handbook 130, Section 2.1.3.(b) will be removed editorially and the reference to Classes 1, 2, and 3 in Section 2.1.3.(c) will be removed editorially.~~

~~NOTE 2~~**NOTE 1:** *The temperature values (e.g., 54 °C, 50. °C, 41.5 °C) are presented in the format prescribed in ASTM E29 “Standard Practice for Using Significant Digits in Test Data to Determine Conformance with Specifications.”*

(Added 2009) (Amended 2012)

2.1.3. Minimum Antiknock Index (AKI). – The AKI shall not be less than the AKI posted on the product dispenser or as certified on the invoice, bill of lading, shipping paper, or other documentation;

2.1.4. Minimum Motor Octane Number. – The minimum motor octane number shall not be less than 82 for gasoline with an AKI of 87 or greater;

2.1.5. Minimum Lead Content to Be Termed “Leaded.” – Gasoline and gasoline oxygenate blends sold as “leaded” shall contain a minimum of 0.013 g of lead per liter (0.05 g per U.S. gallon);

2.1.6. Lead Substitute Gasoline. – Gasoline and gasoline-oxygenate blends sold as “lead substitute” gasoline shall contain a lead substitute which provides protection against exhaust valve seat recession equivalent to at least 0.026 g of lead per liter (0.10 g per U.S. gallon).

2.1.6.1. Documentation of Exhaust Valve Seat Protection. – Upon the request of the Director, the lead substitute additive manufacturer shall provide documentation to the Director that demonstrates that the treatment level recommended by the additive manufacturer provides protection against exhaust valve seat recession equivalent to or better than 0.026 g/L (0.1 g/gal) lead. The Director may review the documentation and approve the lead substitute additive before such additive is blended into gasoline. This documentation shall consist of:

- (a) test results as published in the Federal Register by the EPA Administrator as required in Section 211(f)(2) of the Clean Air Act; or
- (b) until such time as the EPA Administrator develops and publishes a test procedure to determine the additive’s effectiveness in reducing valve seat wear, test results and description of the test procedures used in comparing the effectiveness of 0.026 g per liter lead and the recommended treatment level of the lead substitute additive shall be provided.

2.1.7. Blending. – Leaded, lead substitute, and unleaded gasoline-oxygenate blends shall be blended according to the EPA “substantially similar” rule or an EPA waiver for unleaded fuel.

(Amended 2009)

2.2. Diesel Fuel. – Shall meet the latest version of ASTM D975, “Standard Specification for Diesel Fuel Oils.”

2.2.1. Premium Diesel Fuel. – All diesel fuels identified on retail dispensers, bills of lading, invoices, shipping papers, or other documentation with terms such as premium, super, supreme, plus, or premier must conform to the following requirements:

- (a) **Cetane Number.** – A minimum cetane number of 47.0 as determined by the latest version ASTM D613, “Standard Test Method for Cetane Number of Diesel Fuel Oil”.
- (b) **Low Temperature Operability.** – A cold flow performance measurement which meets the latest version of ASTM D975, “Standard Specification for Diesel Fuel Oils,” tenth percentile minimum ambient air temperature charts and maps by either ASTM Standard Test Method D2500 (Cloud Point) or the latest version of ASTM Standard D4539, “Low Temperature Flow Test, LTFT.” Low temperature operability is only applicable October 1 - March 31 of each year.
- (c) **Thermal Stability.** – A minimum reflectance measurement of 80 % as determined by the latest version ASTM Standard Test Method D6468 (180 min, 150 °C).
- (d) **Lubricity.** – A maximum wear scar diameter of 520 microns as determined by the latest version ASTM D6079, “Standard Test Method for Evaluating Lubricity of Diesel Fuels by the High-Frequency Reciprocating Rig (HFRR).” If an enforcement jurisdiction’s single test of more than 560 microns is determined, a second test shall be conducted. If the average of the two tests is more than 560 microns, the sample does not conform to the requirements of this part.

(Amended 2003)

2.3. Aviation Turbine Fuels. – Shall meet the latest version of ASTM D1655, “Standard Specification for Aviation Turbine Fuels.”

2.4. Aviation Gasoline. – Shall meet the most recent version of one of the following, as appropriate:

- (a) **ASTM D910** – “Standard Specification for Aviation Gasoline;” or
- (b) **ASTM D6227** – “Standard Specification for Grade 82 Unleaded Aviation Gasoline.”

(Amended 2008)

2.5. Fuel Oils. – Shall meet the latest version of ASTM D396, “Standard Specification for Fuel Oils.”

2.6. Kerosene (Kerosine). – Shall meet the latest version of ASTM D3699, “Standard Specification for Kerosine.”

2.7. Ethanol. – Intended for blending with gasoline shall meet the latest version of ASTM D4806, “Standard Specification for Denatured Fuel Ethanol for Blending with Gasolines for Use as Automotive Spark-Ignition Engine Fuel.”

2.8. Liquefied Petroleum (LP) Gases. – Shall meet the latest version ASTM D1835, “Standard Specification for Liquefied Petroleum (LP) Gases.”

NOTE: Also reference Gas Processors Association 2140, Liquefied Petroleum Gas Specification and Test Methods.

2.9. Compressed Natural Gas (CNG). – Shall meet the latest version of SAE J1616, “Recommended Practice for Compressed Natural Gas Vehicle Fuel.”

2.10. E85 Fuel Ethanol. – Shall meet the latest version of ASTM D5798, “Standard Specification for Fuel Ethanol (Ed75-Ed85) for Automotive Spark-Ignition Engines.”

(Added 1997)

2.11. M85 Fuel Methanol. – Shall meet the latest version of ASTM D5797, “Standard Specification for Fuel Methanol M70-M85 for Automotive Spark Ignition Engines.”

(Added 1997)

2.12. Motor Oil. – Shall not be sold or distributed for use unless the product conforms to the following specifications:

- (a) performance claims listed on the label shall be evaluated against the latest version of SAE J183, “Engine Oil Performance and Engine Service Classification (Other than “Energy Conserving,” API 1509 “Engine Oil Licensing and Certifications System,” or other industry standards as applicable;
- (b) the product shall meet its labeled viscosity grade specification as specified in the latest version of SAE J300, “Engine Oil Viscosity Classification; and
- (c) any engine oil that is represented as “energy conserving” shall meet the requirements established by the latest version of SAE J1423, “Classification of Energy Conserving Engine Oil for Passenger Cars, Vans, Sport Utility Vehicles, and Light-Duty Trucks.

(Added 2004)

2.13. Products for Use in Lubricating Manual Transmissions, Gears, or Axles. – Shall not be sold or distributed for use in lubricating manual transmissions, gears, or axles unless the product conforms to the following specifications:

- (a) it is labeled with one or more of the service designations found in the latest version of the SAE Information Report on axle and manual transmission lubricants, SAE J308, and API Publication 1560, and meets all applicable requirements of those designations;
- (b) the product shall meet its labeled viscosity grade classification as specified in the latest version of SAE J306; and
- (c) the product shall be free from water and suspended matter when tested by means of centrifuge, in accordance with the latest version of ASTM D2273, “Standard Test Method for Trace Sediment in Lubricating Oils.”

(Added 2004)

2.14. Products for Use in Lubricating Automatic Transmissions. – Any automatic transmission fluid sold without limitation as to type of transmission for which it is intended shall meet all automotive manufacturers’ recommended requirements for transmissions in general use in the state. Automatic transmission fluids that are intended for use only in certain transmissions, as disclosed on the label of its container, shall meet the latest automotive manufacturers’ recommended requirements for those transmissions. Adherence to automotive manufacturers’ recommended requirements shall be based on tests currently available to the lubricants’ industry and the state regulatory agency. Any material offered for sale or sold as an additive to automatic transmission fluids shall be compatible with the automatic transmission fluid to which it is added, and shall meet all performance claims as stated on the label. Any manufacturer of any such product sold in this state shall provide, upon request by a duly authorized representative of the Director, documentation of any claims made on their product label.

(Added 2004)

2.15. Biodiesel. – B100 biodiesel intended for blending with diesel fuel shall meet the latest version of ASTM D6751, “Standard Specification for Biodiesel Fuel (B100) Blend Stock for Distillate Fuels.”

(Added 2004)

2.16. Biodiesel Blends. – Blends of biodiesel and diesel fuels shall meet the following requirements:

- (a) blends that contain less than or equal to 5 % must meet the latest version of ASTM D975, “Standard Specification for Diesel Fuel Oils”;
- (b) blends greater than 5 % biodiesel and that contain less than or equal to 20 % by volume shall meet the latest version of ASTM D7467, “Standard Specification for Diesel Fuel Oil, Biodiesel Blend (B6 to B20)”;
- (c) use of S15 biodiesel is required when blending into S15 low sulfur motor vehicle diesel fuel when the intention is to certify the fuel as S15 grade; and
- (d) when blends greater than 20 % are offered for sale, the diesel fuel used in the blend shall meet the most latest version of ASTM D975, “Standard Specification for Diesel Fuel Oils,” and the biodiesel blend stock shall meet the specifications of paragraph 2.15. Biodiesel.

(Added 2004) (Amended 2008)

2.17. Hydrogen Fuel. – Shall meet the latest version of SAE J2719, “Hydrogen Fuel Quality for Fuel Cell Vehicles.”

(Added 2012)

Section 3. Classification and Method of Sale of Petroleum Products

3.1. General Considerations.

3.1.1. Documentation. – When products regulated by this rule are sold, an invoice, bill of lading, shipping paper, or other documentation must accompany each delivery other than a retail sale. This document must identify the quantity, the name of the product, the particular grade of the product, the applicable automotive fuel rating, and oxygenate type and content (if applicable), the name and address of the seller and buyer, and the date and time of the sale. Documentation must be retained at the retail establishment for a period not less than thirty days.

(Amended 2008, 2012)

3.1.2. Retail Dispenser Labeling. – All retail dispensing devices must identify conspicuously the type of product, the particular grade of the product, and the applicable automotive fuel rating.

3.1.3. Grade Name. – The sale of any product under any grade name that indicates to the purchaser that it is of a certain automotive fuel rating or ASTM grade shall not be permitted unless the automotive fuel rating or grade indicated in the grade name is consistent with the value and meets the requirements of Section 2, Standard Fuel Specifications.

3.2. Automotive Gasoline and Automotive Gasoline-Oxygenate Blends.

3.2.1. Posting of Antiknock Index Required. – All automotive gasoline and automotive gasoline-oxygenate blends shall post the antiknock index in accordance with applicable regulations, 16 CFR Part 306 issued pursuant to the Petroleum Marketing Practices Act, as amended.

3.2.2. When the Term “Leaded” May be Used. – The term “leaded” shall be used only when the fuel meets specification requirements of paragraph 2.1.5. Minimum Lead Content to be Termed “Leaded.”

3.2.3. Use of Lead Substitute Must be Disclosed. – Each dispensing device from which gasoline or gasoline-oxygenate blends containing a lead substitute is dispensed shall display the following legend: “Contains Lead Substitute.” The lettering of this legend shall not be less than 12.7 mm (½ in) in height and the color of the lettering shall be in definite contrast to the background color to which it is applied.

3.2.4. Nozzle Requirements for Leaded Fuel. – Each dispensing device from which gasoline or gasoline-oxygenate blends that contain lead in amounts sufficient to be considered “leaded” gasoline, or lead substitute engine fuel, is sold shall be equipped with a nozzle spout having a terminal end with an outside diameter of not less than 23.63 mm (0.930 in).

3.2.5. Prohibition of Terms. – It is prohibited to use specific terms to describe a grade of gasoline or gasoline-oxygenate blend unless it meets the minimum antiknock index requirement shown in Table 1. Minimum Antiknock Index Requirements.

| Table 1. Minimum Antiknock Index Requirements | | |
|--|--|----------------------------|
| Term | Minimum Antiknock Index | |
| | ASTM D4814 Altitude Reduction Areas IV and V | All Other ASTM D4814 Areas |
| Premium, Super, Supreme, High Test | 90 | 91 |
| Midgrade, Plus | 87 | 89 |
| Regular Leaded | 86 | 88 |
| Regular, Unleaded (alone) | 85 | 87 |
| Economy | -- | 86 |

(Table 1. Amended 1997)

3.2.6. Method of Retail Sale. – Type of Oxygenate must be disclosed. All automotive gasoline or automotive gasoline-oxygenate blends kept, offered, or exposed for sale, or sold at retail containing at least 1.5 mass percent oxygen shall be identified as “with” or “containing” (or similar wording) the predominant oxygenate in the engine fuel. For example, the label may read “contains ethanol” or “with methyl *tertiary*-butyl ether (MTBE).” The oxygenate contributing the largest mass percent oxygen to the blend shall be considered the predominant oxygenate. Where mixtures of only ethers are present, the retailer may post the predominant oxygenate followed by the phrase “or other ethers” or alternatively post the phrase “contains MTBE or other ethers.” In addition, gasoline-methanol blend fuels containing more than 0.15 mass percent oxygen from methanol shall be identified as “with” or “containing” methanol. This information shall be posted on the upper 50 % of the dispenser front panel in a position clear and conspicuous from the driver’s position in a type at least 12.7 mm (½ in) in height, 1.5 mm (1/16 in) stroke (width of type).

(Amended 1996)

3.2.7. Documentation for Dispenser Labeling Purposes. – The retailer shall be provided, at the time of delivery of the fuel, on an invoice, bill of lading, shipping paper, or other documentation, a declaration of the predominant oxygenate or combination of oxygenates present in concentrations sufficient to yield an oxygen content of at least 1.5 mass percent in the fuel. Where mixtures of only ethers are present, the fuel supplier may identify either the predominant oxygenate in the fuel (i.e., the oxygenate contributing the largest mass percent oxygen) or alternatively, use the phrase “contains MTBE or other ethers.” In addition, any gasoline containing more than 0.15 mass percent oxygen from methanol shall be identified as “with” or “containing” methanol.

This documentation is only for dispenser labeling purposes; it is the responsibility of any potential blender to determine the total oxygen content of the engine fuel before blending.

(Amended 1996)

3.2.8. EPA Labeling Requirements also Apply. – Retailers and wholesale purchaser-consumers of gasoline shall comply with the EPA pump labeling requirements for gasoline containing greater than 10 volume percent (v%) up to 15 volume percent (v%) ethanol (E15) under 40 CFR § 80.1501.

(Added 2012)

3.3. Diesel Fuel.

3.3.1. Labeling of Grade Required. – Diesel Fuel shall be identified by grades No. 1-D, No. 2-D, or No. 4-D.

3.3.2. EPA Labeling Requirements Also Apply. – Retailers and wholesale purchaser-consumers of diesel fuel shall comply with EPA pump labeling requirements for sulfur under 40 CFR § 80.570.

3.3.3. Delivery Documentation for Premium Diesel. – Before or at the time of delivery of premium diesel fuel, the retailer or the wholesale purchaser-consumer shall be provided on an invoice, bill of lading, shipping paper, or other documentation a declaration of all performance properties that qualifies the fuel as premium diesel fuel as required in Section 2.2.1. Premium Diesel Fuel.

(Added 1998) (Amended 1999)

3.3.4. Nozzle Requirements for Diesel Fuel. – Each dispensing device from which diesel fuel is sold at retail shall be equipped with a nozzle spout with a diameter that conforms to the latest version of SAE J285, “Dispenser Nozzle Spouts for Liquid Fuels Intended for Use with Spark Ignition and Compression Ignition Engines.” (Enforceable effective July 1, 2013)

(Added 2012)

(Amended 1998, 1999, 2008, and 2012)

3.4. Aviation Turbine Fuels.

3.4.1. Labeling of Grade Required. – Aviation turbine fuels shall be identified by Jet A, Jet A 1, or Jet B.

3.4.2. NFPA Labeling Requirements also Apply. – Each dispenser or airport fuel truck dispensing aviation turbine fuels shall be labeled in accordance with the most recent edition of National Fire Protection Association (NFPA 407), Standard for Aircraft Fuel Servicing.

NOTE: For example, NFPA 407, 2007 edition: Section 4.3.18 Product Identification Signs. Each aircraft fuel servicing vehicle shall have a sign on each side and the rear to indicate the product. The sign shall have letters at least 75 mm (3 in) high of color sharply contrasting with its background for visibility. It shall show the word “FLAMMABLE” and the name of the product carried, such as “JET A,” “JET B,” “GASOLINE,” or “AVGAS.” (NOTE: Refer to the most recent edition NFTA 407.)

3.5. Aviation Gasoline.

3.5.1. Labeling of Grade Required. – Aviation gasoline shall be identified by Grade 80, Grade 91, Grade 100, or Grade 100LL, or Grade 82UL

(Amended 2008)

3.5.2. NFPA Labeling Requirements also Apply. – Each dispenser or airport fuel truck dispensing aviation gasoline shall be labeled in accordance with the most recent edition of National Fire Protection Association (NFPA) 407, Standard for Aircraft Fuel Servicing.

NOTE: For example, NFPA 407, 2007 edition: Section 4.3.18 Product Identification Signs. Each aircraft fuel servicing vehicle shall have a sign on each side and the rear to indicate the product. The sign shall have letters at least 3 in (75 mm) high of color sharply contrasting with its background for visibility. It shall show the word “FLAMMABLE” and the name of the product carried, such as “JET A,” “JET B,” “GASOLINE,” or “AVGAS.” (NOTE: Refer to the most recent edition NFTA 407.)

3.6. Fuel Oils.

3.6.1. Labeling of Grade Required. – Fuel Oil shall be identified by the grades of No. 1 S500, No. 1 S5000, No. 2 S500, No. 2 S5000, No. 4 (Light), No. 4, No. 5 (Light), No. 5 (Heavy), or No. 6.

(Amended 2008)

3.7. Kerosene (Kerosine).

3.7.1. Labeling of Grade Required. – Kerosene shall be identified by the grades No. 1-K or No. 2-K.

3.7.2. Additional Labeling Requirements. – Each retail dispenser of kerosene shall be labeled as 1-K Kerosene or 2-K. In addition, No. 2-K dispensers shall display the following legend:

“Warning - Not Suitable For Use In Unvented Heaters Requiring No. 1-K.”

The lettering of this legend shall not be less than 12.7 mm (½ in) in height by 1.5 mm (1/16 in) stroke; block style letters and the color of lettering shall be in definite contrast to the background color to which it is applied.

3.8. ~~E85~~ Fuel Ethanol.

3.8.1. How to Identify Fuel Ethanol. – Fuel ethanol above 10 percent mixture shall be identified by the capital letter E followed by the numerical value volume percentage. (Example: E85)

3.8.2. Retail Dispenser Labeling. - Each retail dispenser of fuel mixtures containing no more than 10 percentage denatured ethanol shall be labeled: “This fuel product may contain up to 10 percentage ethanol.” Retail dispensers of fuel ethanol of more than 10 percentage shall be labeled with the capital letter E followed by the numerical value volume percent denatured ethanol and ending with the word “ethanol” (Example: E85 Ethanol)

3.8.3. Labeling Requirements.

- (a) Fuel ethanol shall be labeled with its automotive fuel rating in accordance with 16 CFR Part 306.
- (b) A label shall be posted which states “For Use in Flexible Fuel Vehicles (FFV) Only.” This information shall be clearly and conspicuously posted on the upper 50 % of the dispenser front panel in a type at least 12.7 mm (½ in) in height, 1.5 mm (1/16 in) stroke (width of type). A label shall be posted which states, “Consult Vehicle Manufacturer Fuel Recommendations,” and shall not be less than 6 mm (¼ in) in height by 0.8 mm (1/32 in) stroke; block style letters and the color shall be in definite contrast to the background color to which it is applied.

(Amended 2007 and 2008)

3.9. M85 Fuel Methanol.

3.9.1. How to Identify M85 Fuel Methanol. – Fuel methanol shall be identified as M85.

Example: M85

3.9.2. Retail Dispenser Labeling.

- (a) Fuel methanol shall be labeled with its automotive fuel rating in accordance with 16 CFR Part 306.

Example: M85 Methanol

- (b) A label shall be posted which states “For Use in Vehicles Capable of Using M85 Only.” This information shall be clearly and conspicuously posted on the upper 50 % of the dispenser front panel in a type of at least 12.7 mm (½ in) in height, 1.5 mm (1/16 in) stroke (width of type).

(Amended 2008)

3.10. Liquefied Petroleum Gas (LPG).

3.10.1. How LPG is to be Identified. – Liquefied petroleum gases shall be identified by grades Commercial Propane, Commercial Butane, Commercial PB Mixtures or Special-Duty Propane (HD5).

3.10.2. Retail Dispenser Labeling. – Each retail dispenser of LPGs shall be labeled as “Commercial Propane,” “Commercial Butane,” “Commercial PB Mixtures,” or “Special-Duty Propane (HD5).”

3.10.3. Additional Labeling Requirements. – LPG shall be labeled with its automotive fuel rating in accordance with 16 CFR Part 306.

3.10.4. NFPA Labeling Requirements Also Apply. (Refer to the most recent edition of NFPA 58.)

3.11. Compressed Natural Gas (CNG).

3.11.1. How Compressed Natural Gas is to be Identified. – For the purposes of this regulation, compressed natural gas shall be identified by the term “Compressed Natural Gas” or “CNG.”

3.11.2. Retail Sales of Compressed Natural Gas Sold as a Vehicle Fuel.

3.11.2.1. Method of Retail Sale. – All CNG kept, offered, or exposed for sale or sold at retail as a vehicle fuel shall be in terms of the gasoline liter equivalent (GLE) or gasoline gallon equivalent (GGE).

3.11.2.2. Retail Dispenser Labeling.

3.11.2.2.1. Identification of Product. – Each retail dispenser of CNG shall be labeled as “Compressed Natural Gas.”

3.11.2.2.2. Conversion Factor. – All retail CNG dispensers shall be labeled with the conversion factor in terms of kilograms or pounds. The label shall be permanently and conspicuously displayed on the face of the dispenser and shall have either the statement “1 Gasoline Liter Equivalent (GLE) is equal to 0.678 kg of Natural Gas” or “1 Gasoline Gallon Equivalent (GGE) is equal to 5.660 lb of Natural Gas” consistent with the method of sale used.

3.11.2.2.3. Pressure. – CNG is dispensed into vehicle fuel containers with working pressures of 16 574 kPa, 20 684 kPa, or 24 821 kPa. The dispenser shall be labeled 16 574 kPa, 20 684 kPa, or 24 821 kPa corresponding to the pressure of the CNG dispensed by each fueling hose.

3.11.2.2.4. NFPA Labeling. – NFPA Labeling requirements also apply. (Refer to NFPA 52.)

3.11.3. Nozzle Requirements for CNG. – CNG fueling nozzles shall comply with ANSI/AGA/CGA NGV 1.

3.12. Liquefied Natural Gas (LNG).

3.12.1. How Liquefied Natural Gas is to be Identified. – For the purposes of this regulation, liquefied natural gas shall be identified by the term “Liquefied Natural Gas” or “LNG.”

3.12.2. Labeling of Retail Dispensers of Liquefied Natural Gas Sold as a Vehicle Fuel.

3.12.2.1. Identification of Product. – Each retail dispenser of LNG shall be labeled as “Liquefied Natural Gas.”

3.12.2.2. Conversion Factor. – All retail LNG dispensers shall be labeled with the conversion factor in terms of kilograms or pounds. The label shall be permanently and conspicuously displayed on the face of the dispenser and shall have either the statement “1 Diesel Liter Equivalent (DLE) is equal to 0.756 kg of Natural Gas” or “1 Diesel Gallon Equivalent (DGE) is equal to 6.22 lb of Natural Gas” consistent with the method of sale used.

(Amended 2013)

3.12.2.3. Automotive Fuel Rating. – LNG automotive fuel shall be labeled with its automotive fuel rating in accordance with 16 CFR Part 306.

(Amended 2013)

3.12.2.4. NFPA Labeling. – NFPA Labeling requirements also apply. (Refer to NFPA 57.)

(Amended 2013)

3.13. Oil.

3.13.1. Labeling of Vehicle Engine (Motor) Oil Required.

3.13.1.1. Viscosity. – The label on any vehicle engine (motor) oil container, receptacle, dispenser, or storage tank and the invoice or receipt from service on an engine that includes the installation of vehicle engine (motor) oil dispensed from a receptacle, dispenser, or storage tank shall contain the viscosity grade classification preceded by the letters “SAE” in accordance with the SAE International’s latest version of SAE J300, “Engine Oil Viscosity Classification.”

(Amended 2012)

3.13.1.2. Intended Use. – The label on any vehicle engine (motor) oil container shall contain a statement of its intended use in accordance with the latest version of SAE J183, “Engine Oil Performance and Engine Service Classification (Other than ‘Energy Conserving’).”

(Amended 2012)

3.13.1.3. Brand. – The label on any vehicle engine (motor) oil container and the invoice or receipt from service on an engine that includes the installation of vehicle engine (motor) oil dispensed from a receptacle, dispenser, or storage tank shall contain the name, brand, trademark, or trade name of the vehicle engine (motor) oil.

(Added 2012)

3.13.1.4. Engine Service Category. – The label on any vehicle engine (motor) oil container, receptacle, dispenser or storage tank and the invoice or receipt from service on an engine that includes the installation of vehicle engine (motor) oil dispensed from a receptacle, dispenser, or storage tank shall contain the engine service category, or categories, ~~met~~**displayed** in letters not less than 3.18 mm (¹/₈ in) in height, as defined by the latest version of SAE J183, “Engine Oil Performance and Engine Service Classification (other than ‘Energy Conserving’)” or API Publication 1509, Engine Oil Licensing and Certification System.

(Amended 2012)

3.13.1.4.1. Inactive or Obsolete Service Categories. – The label on any vehicle engine (motor) oil container, receptacle, dispenser, or storage tank and the invoice or receipt from service on an engine that includes the installation of vehicle engine (motor) oil dispensed from a receptacle, dispenser, or storage tank shall bear a plainly visible cautionary statement in compliance with **the latest version of**

SAE J183, “Engine Oil Performance and Engine Service Classification (Other than ‘Energy Conserving’)” Appendix A, whenever the vehicle engine (motor) oil in the container or in bulk does not meet an active API service category as defined by the latest version of SAE J183, “Engine Oil Performance and Engine Service Classification (Other than ‘Energy Conserving’).”

(Added 2012)

3.13.1.5. Tank Trucks or Rail Cars. – Tank trucks, rail cars, and types of delivery trucks that are used to deliver vehicle engine (motor) oil are not required to display the SAE viscosity grade and service category or categories ~~as long as the bill of lading or other documentation provides that information~~ **on such tank trucks, rail cars, and other types of delivery trucks.**

(Added 2012) (Amend 2013)

All references to invoice or receipt will be enforceable effective on July 1, 2013.

3.13.1.6. Documentation. – **When the engine (motor) oil is sold in bulk, an invoice, bill of lading, shipping paper, or other documentation must accompany each delivery. This document must identify the quantity of engine (motor) oil delivered as defined in Sections 3.13.1.1. Viscosity; 3.13.1.2. Intended Use; 3.13.1.3. Brand; 3.13.1.4. Engine Service Category; the name and address of the seller and buyer; and the date and time of the sale. For inactive or obsolete service categories, the documentation shall also bear a plainly visible cautionary statement as required in Section 3.13.1.4.1. Inactive or Obsolete Service Categories, documentation must be retained at the retail establishment for a period of not less than one year.**

(Added 2013)

(Amended 2012 and 2013)

3.13.2. Labeling of Recreational Motor Oil.

3.13.2.1. Viscosity. – The label on each container of recreational motor oil shall contain the viscosity grade classification preceded by the letters “SAE” in accordance with the SAE International’s latest version of SAE J300, “Engine Oil Viscosity Classification.”

3.13.2.2. Intended Use. – The label on each container of recreational motor oil shall contain a statement of its intended use in accordance with the latest version of SAE J300, “Engine Oil Viscosity Classification.”

3.13.3. Labeling of Gear Oil.

3.13.3.1. Viscosity. – The label on each container of gear oil shall contain the viscosity grade classification preceded by the letters “SAE” in accordance with the SAE International’s latest version of SAE J306, “Automotive Gear Lubricant Viscosity Classification” or SAE J300, “Engine Oil Viscosity Classification.”

3.13.3.1.1. Exception. – Some automotive equipment manufacturers may not specify an SAE viscosity grade requirement for some applications. Gear oils intended to be used only in such applications are not required to contain an SAE viscosity grade on their labels.

3.13.3.2. Service Category. – The label on each container of gear oil shall contain the service category, or categories, in letters not less than 3.18 mm ($\frac{1}{8}$ in) in height, as defined by the latest version of SAE J308, “Axle and Manual Transmission Lubricants.”

(Added 2004)

3.14. Automatic Transmission Fluid.

3.14.1. Labeling. – The label on a container of automatic transmission fluid shall not contain any information that is false or misleading. In addition, each container of automatic transmission fluid shall be labeled with the following:

- (a) the brand name;
- (b) the name and place of business of the manufacturer, packer, seller, or distributor;
- (c) the words “Automatic Transmission Fluid”;
- (d) the duty type of classification; and
- (e) an accurate statement of the quantity of the contents in terms of liquid measure.

3.14.2. Documentation of Claims Made Upon Product Label. – Any manufacturer or packer of any product subject to this article and sold in this state shall provide, upon request of duly authorized representatives of the Director, documentation of any claim made upon their product label.

(Added 2004)

3.15. Biodiesel and Biodiesel Blends.

3.15.1. Identification of Product. – Biodiesel shall be identified by the term “biodiesel” with the designation “B100.” Biodiesel blends shall be identified by the term “Biodiesel Blend.”

3.15.2. Labeling of Retail Dispensers.

3.15.2.1. Labeling of Grade Required. – Biodiesel shall be identified by the grades S15 or S500. Biodiesel blends shall be identified by the grades No. 1-D, No. 2-D, or No. 4-D.

3.15.2.2. EPA Labeling Requirements also Apply. – Retailers and wholesale purchaser-consumers of biodiesel blends shall comply with EPA pump labeling requirements for sulfur under 40 CFR § 80.570.

3.15.2.3. Automotive Fuel Rating. – Biodiesel and biodiesel blends shall be labeled with its automotive fuel rating in accordance with 16 CFR Part 306.

3.15.2.4. Biodiesel Blends. - Blends between 5 and 20% biodiesel may be labeled “this product may contain up to 20% biodiesel.”

3.15.2.5. Biodiesel Blends. – When biodiesel blends greater than 20 % by volume are offered by sale, each side of the dispenser where fuel can be delivered shall have a label conspicuously placed that states “Consult Vehicle Manufacturer Fuel Recommendations.”

The lettering of this legend shall not be less than 6 mm ($\frac{1}{4}$ in) in height by 0.8 mm ($\frac{1}{32}$ in) stroke; block style letters and the color shall be in definite contrast to the background color to which it is applied.

3.15.3. Documentation for Dispenser Labeling Purposes. – The retailer shall be provided, at the time of delivery of the fuel, a declaration of the volume percent biodiesel on an invoice, bill of lading, shipping paper, or other document. This documentation is for dispenser labeling purposes only; it is the responsibility of any potential blender to determine the amount of biodiesel in the diesel fuel prior to blending.

3.15.4. Exemption. – Biodiesel blends that contain less than or equal to 5 % biodiesel by volume are exempted from the requirements of Sections 3.15.1. Identification of Product, 3.15.2. Labeling of Retail Dispensers, and 3.15.3. Documentation for Dispenser Labeling Purposes when it is sold as “diesel fuel” as required in Section 3.3. Diesel Fuel.

(Added 2005) (Amended 2008)

Section 4. Retail Storage Tanks and Dispenser Filters

4.1. Water in Gasoline-Alcohol Blends, Biodiesel Blends, E85 Fuel Ethanol, Aviation Gasoline, and Aviation Turbine Fuel. – No water phase greater than 6 mm (¼ in) as determined by an appropriate detection paste or other acceptable means, is allowed to accumulate in any tank utilized in the storage of gasoline-alcohol blend, biodiesel, biodiesel blends, E85 fuel ethanol, aviation gasoline, and aviation turbine fuel.

(Amended 2008 and 2012)

4.2. Water in Gasoline, Diesel, Gasoline-Ether, and Other Fuels. – Water shall not exceed 25 mm (1 in) in depth when measured with water indicating paste or other acceptable means in any tank utilized in the storage of diesel, gasoline, gasoline-ether blends, and kerosene sold at retail except as required in Section 4.1. Water in Gasoline-Alcohol Blends, Biodiesel Blends, E85 Fuel Ethanol, Aviation Gasoline, and Aviation Turbine Fuel.

(Amended 2008 and 2012)

4.3. Dispenser Filters.

4.3.1. Engine Fuel Dispensers.

- (a) All gasoline, gasoline-alcohol blends, gasoline-ether blends, E85 fuel ethanol and M85 methanol dispensers shall have a 10 micron or smaller nominal pore-sized filter.
- (b) All biodiesel, biodiesel blends, diesel, and kerosene dispensers shall have a 30 micron or smaller nominal pore-sized filter.

4.3.2. Delivery of Aviation Fuel and Gasoline.

- (a) Fuel delivery of aviation turbine fuel into aircraft shall be filtered through a fuel filter/separator conforming to API 1581, “Specification and Qualification Procedures for Aviation Jet Fuel Filter/Separators.”
- (b) Fuel delivery of aviation gasoline into aircraft shall be filtered through a fuel filter/separator conforming to API 1581, “Specification and Qualification Procedures for Aviation Jet Fuel Filter/Separators.”

(Added 2008)

4.4. Product Storage Identification.

4.4.1. Fill Connection Labeling. – The fill connection for any fuel product storage tank or vessel supplying engine-fuel devices shall be permanently, plainly, and visibly marked as to the product contained.

(Amended 2008)

4.4.2. Declaration of Meaning of Color Code. – When the fill connection device is marked by means of a color code, the color code shall be conspicuously displayed at the place of business.

4.5. Volume of Product Information. – Each retail location shall maintain on file a calibration chart or other means of determining the volume of each regulated product in each storage tank and the total capacity of such storage tank(s). This information shall be supplied immediately to the Director.

Section 5. Condemned Product

5.1. Stop-Sale Order at Retail. – A stop-sale order may be issued to retail establishment dealers for fuels failing to meet specifications or when a condition exists that causes product degradation. A release from a stop-sale order will be awarded only after final disposition has been agreed upon by the Director. Confirmation of disposition shall be submitted in writing on form(s) provided by the Director and contain an explanation for the fuel's failure to meet specifications. Upon discovery of fuels failing to meet specifications, meter readings and physical inventory shall be taken and reported in confirmation for disposition. Specific variations or exemptions may be made for fuels designed for special equipment or services and for which it can be demonstrated that the distribution will be restricted to those uses.

5.2. Stop-Sale Order at Terminal or Bulk Plant Facility. – A stop-sale order may be issued when products maintained at terminals or bulk plant facilities fail to meet specifications or when a condition exists that may cause product degradation. The terminal or bulk storage plant shall immediately notify all customers that received those product(s) and make any arrangements necessary to replace or adjust to specifications those product(s). A release from a stop-sale order will be awarded only after final disposition has been agreed upon by the Director. Confirmation of disposition of products shall be made available in writing to the Director. Specific variations or exemptions may be made for fuels used for blending purposes or designed for special equipment or services and for which it can be demonstrated that the distribution will be restricted to those uses.

Section 6. Product Registration

6.1. Engine Fuels Designed for Special Use. – All engine fuels designed for special use that do not meet ASTM specifications or standards addressed in Section 2. Standard Fuel Specifications shall be registered with the Director on forms prescribed by the Director 30 days prior to when the registrant wishes to engage in sales. The registration form shall include all of the following information:

6.1.1. Identity. – Business name and address(es).

6.1.2. Address. – Mailing address, if different than business address.

6.1.3. Business Type. – Type of ownership of the distributor or retail dealer, such as an individual, partnership, association, trust, corporation, or any other legal entity or combination thereof.

6.1.4. Signature. – An authorized signature, title, and date for each registration.

6.1.5. Product Description. – Product brand name and product description.

6.1.6. Product Specification. – A product specification sheet shall be attached.

6.2. Renewal. – Registration is subject to annual renewal.

6.3. Re-registration. – Re-registration is required 30 days prior to any changes in Section 6.1. Engine Fuels Designed for Special Use.

6.4. Authority to Deny Registration. – The Director may decline to register any product that actually or by implication would deceive or tend to deceive a purchaser as to the identity or the quality of the engine fuel.

6.5. Transferability. – The registration is not transferable.

Section 7. Test Methods and Reproducibility Limits

7.1. ASTM Standard Test Methods. – ASTM Standard Test Methods referenced for use within the applicable Standard Specification shall be used to determine the specification values for enforcement purposes.

7.1.1. Premium Diesel. – The following test methods shall be used to determine compliance with the premium diesel parameters:

- (a) **Cetane Number.** – ASTM D613, “Standard Test Method for Cetane Number of Diesel Fuel Oil”;
- (b) **Low Temperature Operability.** – ASTM D4539, “Standard Test Method for Filterability of Diesel Fuels by Low-Temperature Flow Test (LTFT) or ASTM D2500, “Standard Test Method for Cloud Point of Petroleum Products” (according to marketing claim);
- (c) **Thermal Stability.** – ASTM D6468, “Standard Test Method for High Temperature Stability of Middle Distillate Fuels” (180 min, 150 °C); and
- (d) **Lubricity.** – ASTM D6079, “Standard Test Method for Evaluating Lubricity of Diesel Fuels by the High Frequency Reciprocating Rig (HFRR).”

(Amended 2003)

7.2. Reproducibility Limits.

7.2.1. AKI Limits. – When determining the antiknock index (AKI) acceptance or rejection of a gasoline sample, the AKI reproducibility limits as outlined in the latest version of ASTM D4814, “Standard Specification for Automotive Spark-Ignition Engine Fuel, Appendix X1 shall be acknowledged for enforcement purposes.

7.2.2. Reproducibility. – The reproducibility limits of the standard test method used for each test performed shall be acknowledged for enforcement purposes, except as indicated in Section 2.2.1. Premium Diesel Fuel and Section 7.2.1. AKI Limits. No allowance shall be made for the precision of the test methods for aviation gasoline or aviation turbine fuels.

(Amended 2008)

7.2.3. SAE Viscosity Grades for Engine Oils. – All values are critical specifications as defined in the latest version of ASTM D3244, “Standard Practice for Utilization of Test Data to Determine Conformance with Specifications.” The product shall be considered to be in conformance if the Assigned Test Value (ATV) is within the specification.

(Added 2008)

7.2.4. Dispute Resolution. – In the event of a dispute over a reported test value, the guidelines presented in the latest version of ASTM D3244, “Standard Practice for Utilization of Test Data to Determine Conformance with Specifications,” shall be used to determine the acceptance or rejection of the sample.

7.2.5. Additional Enforcement Action. – The Director may initiate enforcement action in the event that, based upon a statistically significant number of samples, the average test result for products sampled from a particular person is greater than the legal maximum or less than the legal minimum limits (specification value), posted values, certified values, or registered values.

(Added 2008)

Section 8. Effective Date

This regulation shall become effective on April 1, ~~2013~~2014.

MARKUP COPY

V. Examination Procedure for Price Verification

as adopted by
The National Conference on Weights and Measures*

A. Background

The NCWM established the Price Verification Working Group in 1993 to respond to public concern about price accuracy in retail stores. More than 500 retailers, consumer representatives, and state and local weights and measures officials participated in the development of the procedure. It was adopted by the NCWM at the 80th Annual Meeting in 1995.

The procedure applies to all retail stores, including food, hardware, general merchandise, drug, automotive supply, convenience, and club or other stores. Model inspection reports are included to promote the collection of uniform data. The model reports and uniform procedures will serve as the foundation for the collection and summarization of price accuracy data on a national basis. This information may be used to provide reliable information on price accuracy with a national perspective. The procedure provides administrators with the tools, guidance, and background information, as well as uniform test procedures and enforcement practices, to enhance the economic well-being of consumers and retail businesses in their jurisdiction. By implementing this program in cooperation with industry, officials will help to restore and maintain consumer confidence in retail pricing practices and technologies, such as scanners, and provide economic benefits for consumers and the business community.

B. Status of Promulgation

The Examination Procedure for Price Verification was recommended for adoption by the Conference in 1995. The table beginning on page 10 shows the status of adoption of the procedure.

**The National Conference on Weights and Measures (NCWM) is supported by the National Institute of Standards and Technology (NIST) in partial implementation of its statutory responsibility for “cooperation with the states in securing uniformity in weights and measures laws and methods of inspection.”*

THIS PAGE INTENTIONALLY LEFT BLANK

MARKUP COPY

Examination Procedure for Price Verification

Section 1. Scope

These procedures may be used to conduct price verification inspections in any type of store, including those that use Universal Product Code (UPC) scanners and price-look-up codes at the check-out counter as a means for pricing. Procedures are included for test purchases and verifying manual entries. The purpose of the procedure is to ensure that consumers are charged the correct price for the items they purchase. The “randomized” and “stratified” sampling procedures are intended for use in routine inspections to determine how well a store is maintaining price accuracy. Nothing in this procedure should be construed or interpreted to redefine any state or local law or limit any jurisdiction from enforcing any law, regulation, or procedures that relates to the accuracy of advertisements of retail prices, or any other legal requirement.

Section 2. Definitions

2.1. Area. – “Entire store,” a “department,” “grouping of shelves or displays,” or other “section” of a store as defined by the inspector from which samples are selected for verification. “Non-public” areas of a store are not included (e.g., the area in a pharmacy where controlled drugs are kept or product store rooms).

2.2. Cents-off Representation. – Any printed matter consisting of the words “cents off” or words of similar import placed upon any item or on a label affixed or adjacent to an item, stating or representing by implication that it is offered for sale at a lower price than the ordinary and customary retail selling price (e.g., 15 % off, bonus offers, 2 for 1, or 1-cent sales, etc.).

2.3. Direct-Store-Delivery (DSD) Item. – An item delivered to a store, and usually priced, by route salespeople (e.g., milk, beer, soft drinks, bread, and snack foods).

2.4. Displays.

- (a) **Aisle Stacks or End-of-Aisle Displays.** – Displays located in freestanding units or attached at the end of or adjacent to a tier of shelves.
- (b) **Tie-in Displays.** – Displays of related products at secondary locations in a store (e.g., barbecue sauce on shelves in an aisle that may also be simultaneously displayed in the meat department of a food store).
- (c) **Multiple Displays.** – Displays of the same product at several locations in a store.

2.5. Hand-held Scanning Device. – A portable device that scans UPC codes and also allows for the comparison of the price displayed on a shelf, item, or otherwise advertised to the price for the item in the point-of-sale database.

NOTE: These devices either retain a “batch” file of entered prices and identities for later comparison to the database or operate “on-line” via FM radio to the database. When used for price verification, they shall only be used with the active point-of-sale database. If you use a hand-held scanner, verify all price discrepancies by scanning the item at a check-out register and request a printed receipt to document the price that consumers would be charged.

2.6. Enforcement Levels.

NOTE: These recommendations are not intended to modify the enforcement policy of any jurisdiction unless they are adopted by the jurisdiction.

- (a) **Lower levels of enforcement actions.** – Includes increased inspection frequency, stop-sale or correction orders, warning letters, and other notifications of noncompliance.

- (b) **Higher levels of enforcement actions.** – Includes issuance of citations, administrative hearings, civil penalties, or prosecution under criminal statutes.

2.7. Inspection Types.

- (a) **Automated Inspection.** – Inspections that are conducted using a hand-held scanning device.
- (b) **Manual Inspection.** – Removing items from displays and taking them to a check-out terminal to verify the price (e.g., select the items and either (1) take them to a check-out terminal for scanning or (2) record the product identity, UPC number, and shelf price for each package on an inspection report) and then manually entering the UPC numbers in the register. The manual entries may be made by the official or by a store employee.

2.8. Inspection Frequency.

These recommendations do not modify the inspection policy of any jurisdiction unless adopted by the jurisdiction.

Inspection Control. – *After a program has been in place for a period of time and a database is established, procedures can be developed to randomly select stores for inspection, or to focus inspections on stores with low levels of compliance.*

- (a) **Normal Inspection Frequency.** – An inspection made at the customary time interval used by an enforcement agency. Inspections may be conducted during normal business hours. Stores under this normal frequency should be inspected semi-annually or annually.
- (b) **Increased Inspection Frequency.** – An inspection made more often than with the customary time interval, usually as a follow-up on prior violations. Inspections may be conducted during the normal business hours. Stores under this increased frequency should be inspected on a quarterly, bi-monthly, or more frequent basis.
- (c) **Term of Increased Inspection Frequency.** – A store placed on an increased inspection frequency shall remain at that frequency until there are two consecutive inspections with an accuracy of 98 % or higher.
- (d) **Special Inspection.** – An inspection that is conducted as a follow-up to a prior inspection or to investigate a complaint.

2.9. Inspection Lot. – A group of items available for testing in an “area” or “areas.” (See 2.1. “Area.”)

2.10. Merchandise Group. – A group of products identified under a common heading for inspection purposes only (e.g., “advertised sale” items, “end-of-aisle” items, “direct delivery” items, “cents-off” items, or all the items in the “men’s” department in a department store).

2.11. Not-on-File Item. – Items not found in the point-of-sale database. When found, another item is selected at random (e.g., an item on either side of the one that was not on file) to replace the item in the sample. A “not-on-file” item is not an error unless you determine that the price “charged” for the item is incorrect by conducting a test purchase or by asking the check-out clerk to determine the price by using the store’s written or stated policy or procedures. If the price is found to be inconsistent, the error is included in the total.

2.12. Notification of Noncompliance. – Any written notice given to a store describing the violations of the law that were found.

2.13. Price Look-Up Code (PLU). – A pricing system where numbers are assigned to items or commodities, and the price is stored in a database for recall when the numbers are manually entered. PLU codes are used with scales, cash registers, and point-of-sale systems.

2.14. Prices. – These definitions do not amend or effect the provisions of any law, regulation, or other test procedure.

- (a) **Misrepresented Price.** – The price charged differs from the price at which the item is offered, exposed, or advertised for sale, or that the price is different from the price on the item, shelf label, or sign.
- (b) **Price Charged.** – The price charged for an item and either displayed on the automated device or on the receipt issued by the device, whether the item is scanned or actually purchased, the device is computing or recording while in a training or inspection mode, or by using the hand-held device tied to the point-of-sale database.
- (c) **Overcharge.** – The price charged for an item is more than the lowest advertised, quoted, posted, or marked price.
- (d) **Undercharge.** – The price charged for an item is less than the lowest advertised, quoted, posted, or marked price.
- (e) **Intentional Undercharge.** – Undercharges are not counted as errors if the store provides, at the time of inspection, information that confirms that the price error was intentional (e.g., an undercharge that occurs when a store lowers a price in a database before it changes shelf tags or signs in anticipation of selling the item at a lower price, or when a store increases the price or advertised price of an item, and then increases the price in the database, or when a discounted price is rounded to a lower value).

2.15. Pricing Coordinator. – The individual designated by the store to control and maintain “pricing integrity” in the store, although the title will differ among retailers.

2.16. Pricing Integrity. – Ensuring that the computer price file and/or the price charged to consumers at a cash register is the same price that is marked on the product, in an advertisement, and/or the shelf tag.

2.17. Sample. – The number of items selected for testing from the inspection lot.

2.18. Scanner. – An electronic system that employs a laser bar code reader to retrieve product identity, price, and other information stored in computer memory.

2.19. Stock-Keeping Unit (SKU). – A system of product identity and pricing similar to PLUs.

2.20. Store-Coded Item. – The application of UPC codes to items in the store. Scales in the meat, deli, and other departments generate UPC labels that include identity and price information that can be read by point-of-sale scanners.

2.21. Stop-Sale Order. – An official document placing a package or an amount of any commodity off-sale, that is offered or exposed for sale in violation of the law.

2.22. Ticketed Merchandise. – Items from which the price must be read from a ticket (or price sticker) and manually keyed into a register.

2.23. Universal Product Code (UPC). – A unique symbol that consists of a machine readable code and human-readable numbers. UPCs are printed on package labels or are applied with tags or labels. UPC codes may be printed for random weight packages by price computing scales. UPC symbols must meet the standards established by the GS1 US (formerly the Uniform Code Council [UCC]) in order for them to “scan” accurately. The size and clarity of the print and clear area surrounding the symbol are just a few of the factors that affect accuracy. The GS1 US issues codes and answers technical questions. For more information, contact GS1 US, at 7887 Washington Village Drive, Suite 300, Dayton, OH 45459, telephone: (937) 435-3870, FAX (937) 435-7317, or e-mail info@gs1us.org. You can visit them on the web at www.gs1us.org.

Section 3. Test Notes

3.1. Safety and Health. – Practice safe work habits to avoid personal injuries or property damage. Be aware of and follow all safety or sanitation rules at the inspection site. Handle perishable, dairy, or frozen products properly to avoid damage (e.g., avoid defrosting frozen foods or allowing dairy products to warm to room temperature that may result in spoilage).

3.2. Confidentiality of Findings. – Inspection findings should be discussed only with an authorized store representative and released only in accordance with applicable public records laws.

Section 4. Materials and Equipment

The following materials and equipment are recommended for use in conducting the inspections in this procedure:

Inspection report:

- Copy of laws or regulations
- Hand-held counter or Price Verification Tally Sheets
- 1 lb (or 1 kg) test standard
- Merchandise cart (if required and available)

Other equipment and materials provided by the store when available:

- Current newspaper advertisement or store sales brochures
- Hand-held scanning device(s) – Stores are not required to have this equipment or to make it available for your use. However, many stores use this equipment to maintain price integrity and may make it available for your use on request.

Section 5. Pre-Inspection Tasks

Prior to conducting an inspection, it is recommended that you contact the store management, identify yourself, and explain the purpose of your visit. Determine if there are any health, sanitation, or safety rules. If requested, provide information on the law or the inspection procedure.

NOTE: *When verifying manual price entries or conducting test purchases, store management is typically not notified of the test until the items have been totaled and the transaction completed.*

- (a) Notify store representatives that they are invited to participate in the inspection.
- (b) If the store makes a hand-held scanning device available for use, request instructions on how to operate it properly. It is acceptable for the “pricing coordinator” to operate the scanning device and participate in the inspection.
- (c) If you use the manual inspection procedure, advise the store representative that you will return the merchandise to its display location unless the store representative wants to restock the items, which is acceptable. Determine which check-out location to use. Arrange to have the register set so that the items you verify are not included in sales records.
- (d) Conduct inspections in a manner that does not disrupt normal business activities.

Section 6. Inspection

Perform the following inspections:

6.1. Position of Equipment. – Determine if customer indications on point-of-sale systems meet NIST Handbook 44, General Code, User Requirement, 3.3. Position of Equipment. A device equipped with a primary indicating element and used in direct sales shall be so positioned that its indications may be accurately read and the weighing and measuring operation may be observed from some “reasonable” customer position.

NIST Handbook 44 defines “point-of-sale system” as an assembly of elements including a weighing element, indicating element, and a recording element (and may be equipped with a scanner) used to complete a direct sale transaction.

NOTE: The importance of consumer access to the cash register display of product information and price cannot be overstated. If consumers cannot verify prices as the items are being scanned, they must wait until the transaction is completed (i.e., they must pay by cash, check, or credit card) before they receive the receipt and can confirm the prices charged for the items.

6.2. Other.

- (a) If you use a cash register, verify the accuracy and legibility of information provided on register’s receipts.
- (b) Conduct inspections to enforce local requirements if your jurisdiction has specific laws or regulations relating to price marking, shelf labels, or unit pricing.

Section 7. Test Procedures

These procedures shall be used to conduct inspections in any type of store, whether the store uses scanners or automated price look-up registers, or where a clerk manually enters the prices.

7.1. Application of Sampling Plans.

- (a) For normal or increased frequency inspections, follow the procedures referred to in Columns 1, 2, and 3 in Table 1. Samples, Sample Collection, and Accuracy Requirements.
- (b) For special inspections, use the test procedures in Section 7.2. Table 1. Samples, Sample Collection, and Accuracy Requirements or 7.4. Procedure for Test Purchases and for Verifying Manually Entered Prices.

7.2. Table 1. Samples, Sample Collection, and Accuracy Requirements.

7.2.1. How to Use the Table:

- (a) Look in Column 1 for the type of store you are inspecting; select the appropriate sample size from Column 2; then refer to Column 3 for the type of sample collection plan to use.
- (b) Follow the single-stage or two-stage sampling plans to conduct the inspection and collect the samples using either the “randomized” or “stratified” sample collection procedures described in Section 7.3. Sample Collection Procedures or the procedure in Section 7.4. Procedure for Test Purchases and for Verifying Manually Entered Prices.
- (c) Apply the accuracy requirements for the appropriate sample size in Column 4.

7.2.2. Samples. – Refer to Column 2 in Table 1. Samples, Sample Collection, and Accuracy Requirements to determine how many items to select for the store type and whether to use the single-stage or two-stage sampling plan. You may use either:

- (a) **Single-Stage Sample.** – A single-stage sample is typically used for, but is not limited to, stores where a hand-held scanner device is available for the inspection; or
- (b) **Two-Stage Sample.** – A two-stage sample saves time. If the sample (usually one-half the total sample size) taken in the first-stage meets the accuracy requirements specified in Column 4 in Table 1. Samples, Sample Collection, and Accuracy Requirements, the inspection is complete. However, if the errors in the first-stage sample fall within the limits set in Column 4, the second-stage of the sample is taken.

7.3. Sample Collection Procedures (for use with either manual or automated inspection procedures). – These sample collection procedures may be used to conduct either manual or automated inspections with a single-stage or two-stage sample. That is, you can either use a hand-held scanning device to verify the price of an item (automated), or you can remove the items from display and take them to a check-out location to verify the price of the item (manual) regardless of which sample collection procedure is used. No sample collection procedure is ideal for all retail store arrangements. You can modify the procedure to fit each store, but you should adhere to the sample size and sample collection procedures described in Table 1. Samples, Sample Collection, and Accuracy Requirements. When using any of the procedures, test the store as a whole unit by taking samples from all parts of the store, or divide the store into “areas” and select samples from several “areas” (e.g., at least 10 areas, or one-third or one-half of the “areas”).

| Table 1. Samples, Sample Collection, and Accuracy Requirements | | | |
|--|---|--|--|
| Column 1. Type of Store | Column 2. Samples | Column 3. Sample Collection Procedures | Column 4. Accuracy Requirements (See Section 10) |
| <p>Convenience or Any Other Small Retail Store</p> <p>NOTE: For this procedure, a small store is typically one with three or fewer check-out registers.</p> | <p>Two-Stage Sample:</p> <p>First Stage = 25 items</p> <p>Second Stage = 25 items or more</p> <p>Total = 50 items or more</p> <p>or</p> <p>Single-Stage Sample:</p> <p>50 items or more</p> | <p>Use the Randomized Sample Collection in 7.3.1 or the Stratified Sample Collection in 7.3.2.</p> <p>and</p> <p>Use Manual or Automated Inspection Procedures</p> <p>NOTE: Test the store as a whole unit by taking samples from all “areas” of the store,</p> | <p>If 1 error is found in the 25-item sample, test an additional 25 items.</p> <p>If more than 1 error is found in the 50-item sample, the store fails.</p> <p>NOTE: If more than 1 error is found in the first 25 items, the store fails.</p> |
| <p>All Other Retail Stores</p> | <p>Two-Stage Sample:</p> <p>First Stage = 50 items</p> <p>Second Stage = 50 items or more</p> <p>Total = 100 items or more</p> | <p>or</p> <p>divide the store into “areas” and select samples from several “areas” (e.g., at least 10 or one-third of the “areas”)</p> | <p>If 1 error is found in the 50-item sample, the store passes.</p> <p>If 2 errors are found in the 50-item sample, test an additional 50 items.</p> <p>If more than 2 errors are found in the 100 item sample, the store fails.</p> <p>NOTE: If more than 2 errors are found in either stage, the store fails.</p> |
| | <p>Single-Stage Sample:</p> <p>100 or more items</p> | | <p>If more than 2 errors are found in the 100-item sample the store fails;</p> <p>or</p> <p>If more than 100 items are sampled, the error rate shall not exceed 2 %.</p> |

NOTE 1: These sampling procedures allow flexibility in sample collection for use in any type or size of store. You can take several different approaches and select a number of “areas” to sample using the sample sizes in Table 1. For example, to perform a 100-item inspection in a department store with 20 “areas,” you can either verify 5 items in an “area,” 10 items in each of 10 “areas,” or 20 items from each of 5 “areas.”

NOTE 2: The sample sizes used for routine inspections in this procedure should not be used to estimate the overall accuracy of prices in a store.

NOTE 3: *In some stores, price reductions are not programmed into the point-of-sale system. Instead, discounts are manually entered by a sales clerk; however, the sales clerks should have a means of identifying a sale item. When conducting normal inspections, verify the price of the sale items by allowing the sales clerk to determine the price of the item using the store's customary procedures. This will ensure that the customer receives the correct price regardless of the location where the check-out occurs.*

7.3.1. Randomized Sample Collection. – In “randomized” sample collection, all items in an “area” have an equal chance of being included in the sample. This test procedure has several benefits, including: (1) having more effective coverage and being simpler to conduct because you select items by count following a systematic pattern throughout the store, and (2) ensuring that a wider range of items are verified, which increases scrutiny; therefore, there is greater confidence in the results. With most samples, several items will be verified in each “area” of the store. Since store sizes differ, this number will vary, but samples should be taken from a wide variety of items (and merchandise groups) from locations throughout the store or “area.”

The steps of the randomized sampling collection procedure are as follows:

- (a) Count the number of “areas” in the store which have products to be verified:
 - (1) Stand-alone counters and displays or whole departments (e.g., bakery or seafood, or “men’s clothing” or “sporting goods” department, etc.) are considered and counted as individual “areas” to be sampled.
 - (2) End of aisle displays may be considered as a single, distinct “area” and either verified separately or included as part of one side of an aisle.
- (b) The sample size (e.g., 100 items) is divided by the number of “areas” to determine the number of items to be sampled from each “area.” Depending on the number of areas in the store, you may calculate a fractional number of items per area. In this case, round off the sample size and select one or two additional items from an “area” to complete the full sample size of 100 items.

7.3.1.1. Example 1. Illustrations of the Randomized Sampling Procedure.

- (a) Figure 1 illustrates how the randomized sampling procedures are used in a food store. This example is based on a 100-item sample. To simplify the selection process, simply divide the store into 4 major “areas” and select samples as follows:

Examples:

- Select 5 items from all of the shelves and displays in the produce section which are grouped as a single “area.”
 - Select 85 items by choosing 5 items from either side of several of the 13 aisles (e.g., there are 26 rows of shelves from which samples may be selected. To select 85 items, select 5 items from 17 of the 26 rows of shelves).
 - Select 5 items from the counters along the back of the store, and
 - Select 5 items from the deli-bakery and the cash register areas which are grouped as a single “area.”
- (b) Figures 2 and 3 illustrate how the randomized sampling procedures may be used in any store. The examples are based on a 100-item sample for stores that have a total of 30 “areas” to sample. The procedure allows the flexibility needed to adjust the sample to fit the store layout. To simplify the selection process, the stand-alone displays may be grouped together as an “area” to be sampled.

The following breakdown of “areas” is illustrated in Figure 2; the same approach is used in Figure 3. Figure 4 illustrates an example of sampling 100 items by selecting 20 items from 5 different areas in a department store.

- 1 - All shelves and displays in the produce section are grouped as a single “area.”
- 28 - The 13 aisles (26 rows of shelves), the counters along the back of the store, and the cash register areas are counted as “areas.”
- 1 - The “end-of-aisle” displays at the front and back of the store are grouped as a single “area.”
- 30 - Total “areas”

- (1) To select samples from the entire store, divide 100 by 30 to calculate how many “samples” to take from each “area.” In this example, $100 \div 30 = 3.3$ items per area. Rounding down to 3 items, take a total of 90 samples from the different “areas,” then select an additional one (1) item from each of 10 “areas” to obtain a sample of 100 items.
- (2) If you round up to 4 items per area, you take a total of 120 samples, or
- (3) You may select 10 items from 10 “areas.”

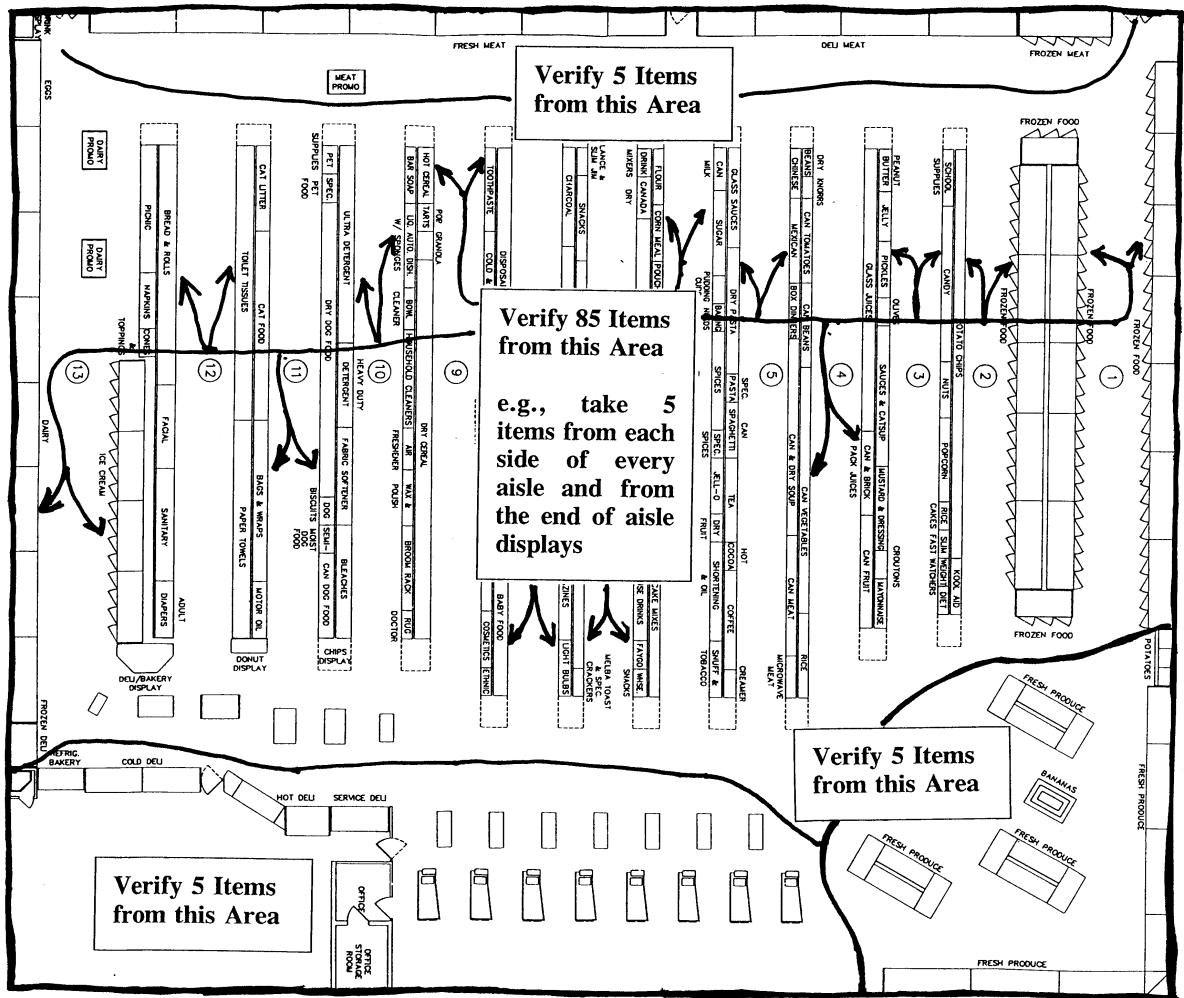

Figure 1. Illustration of the Randomized Sampling Procedure

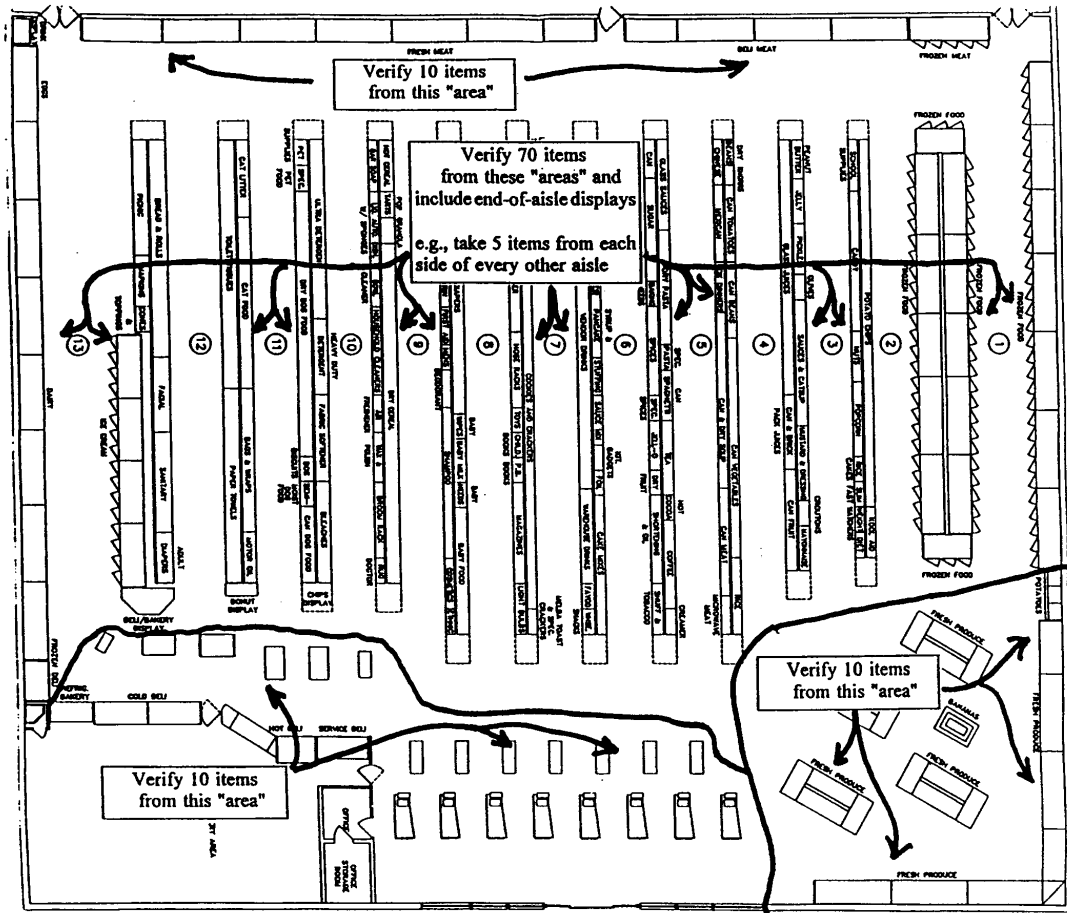

Figure 2. Illustration of the Randomized Sampling Procedure

- (c) Start in any “area” in the store at any shelf, rack, or display (top, bottom, front, back; anywhere on a circular rack or display). Begin with the first, second, or third item and count either 5, 10, or 15 items along the shelf (varying the number of items counted depending on how many items are available on the shelf) or along the aisle. Select the 5th, 10th, or 15th item as appropriate (See Figures 5, 6, and 7). Only select one item from each brand or product (if they are the same price) from a display that has two or more items of the same product size and price displayed side by side. You can change the number of items you count off as often as necessary during the inspection.
- (d) Either verify the price with a hand-held scanning device or take the item (along with the other items you select) to the check-out location to verify the price, keeping count of the items using a hand counter or tally sheet. If the price of an item is incorrect, record the item’s name, description, and price along with other information (e.g., whether the product is on sale, aisle location so you can easily find the items again to verify the error, etc.).
- (e) From the first item sampled, move down (or up) one shelf to the item most directly below (or above) and count 5, 10, or 15 items in the same direction and sample the 5th, 10th, or 15th items, as appropriate. After the number of items to be verified in each “area” have been selected, go to the next “area” and start on the next shelf (either down or up) from where the previous sample was selected, count 5, 10, or 15 items and select the appropriate item using the count system until the

required number of samples is selected. If you have sampled an item on the bottom (or top) shelf and have more items to test in the “area,” simply go up (or down) one shelf. This will create a “zigzag” trail up and down the display.

NOTE: *Randomness can be increased by starting on different shelves or at the midpoint or rear of an aisle during an inspection, or by starting at different locations in a store on subsequent inspections. Always start at a different location on subsequent inspections of a store. To maintain “randomness,” do not search for obvious pricing errors. If you see pricing errors, have them corrected. The sample should not include more than one of the same item from the same display. If an item is out of stock, select the next item.*

(f) This procedure is repeated for all “areas” until you complete the sample. (See following Notes)

NOTE 1: *Include at least 5 to 10 Price Look Up (PLU) and store-coded items in the samples. In food stores, these items do not usually have to be removed from the produce, bulk foods section, or deli display for use in this procedure. You can use a hand-held scanner or record the identity and item price designated at the product sales display of the items from the different department (produce, bakery, deli), if available, for price comparison through either the PLU programmed in the department’s scale or at the point-of-sale system. Have the PLU entered in the scale (See Note 2) or point-of-sale system (or have “store-coded” items scanned) and record the price, comparing it with the displayed sale price. Record any errors (See Note 3). When checking “store-coded” items from the meat or other departments, remember a “UPC symbol” on a random weight label is read by a scanner to obtain the total price and identity. The price is not stored in the point-of-sale database, but in the memory of the prepackaging scale.*

NOTE 2: *Some scales or point-of-sale systems do not display or record the unit price associated with the PLU unless a weight is on the scale. For this type of device, a one pound standard (or 1 kg) is placed on the scale load-receiving element. Some systems automatically deduct tare, so check to make sure that this does not affect the price indication.*

NOTE 3: *When you manually enter PLU codes and find errors, reenter the PLU number to ensure that the error was not caused by a keying mistake and that the item was identified accurately.*

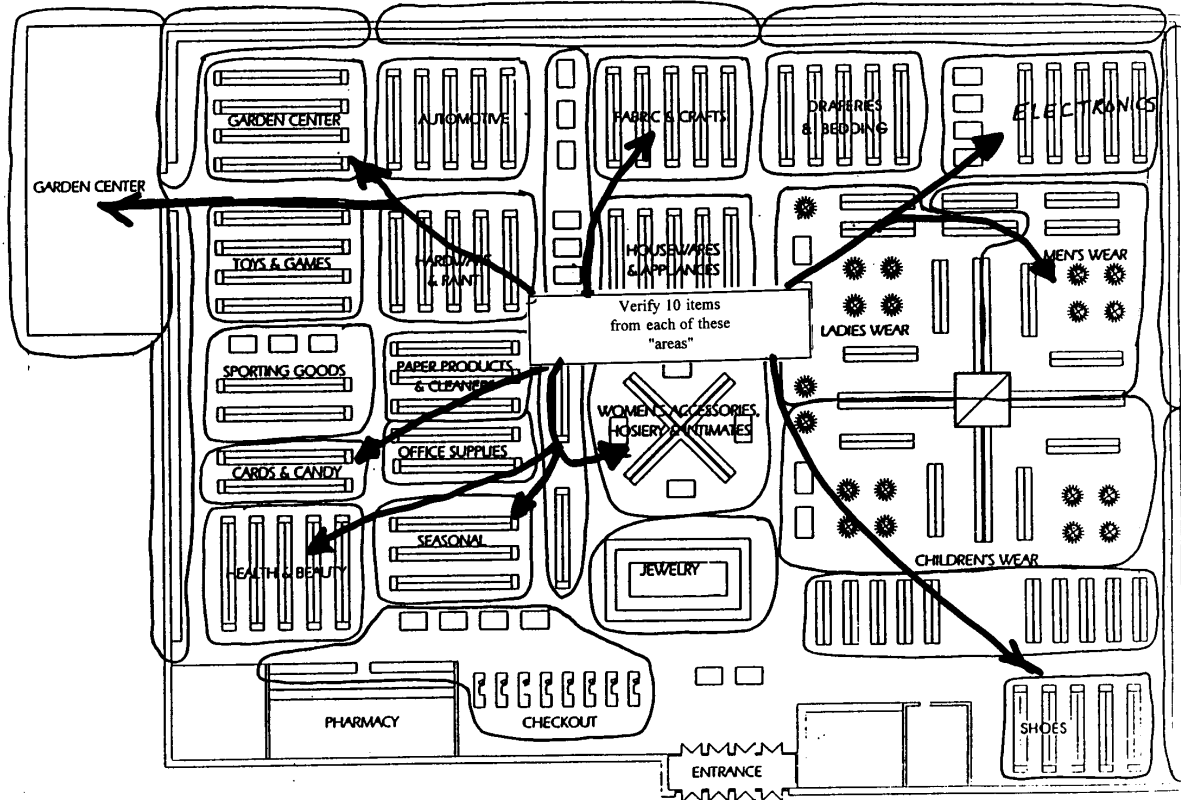

Figure 3. Illustration of the Randomized Sampling Procedure

7.3.2. Stratified Sample Collection. – Stratified sample collection (i.e., selecting samples from specific merchandise groups) of items on sale, specials, seasonal items, or items on end-of-aisle displays) is typically used (e.g., if a store has failed an inspection based on the randomized sample collection procedures) to focus on specific merchandise groups that appear to have more errors than others (e.g., you find that many of the errors found in the randomized sample were in “advertised specials” or with “discontinued items”). You can also combine sample collection procedures by using a “randomized/stratified” approach. The “stratified” approach may be used the first time you inspect a store, in stores that have just implemented scanning, in stores that have high error rates on particular groups of items in past inspections, or in responding to consumer complaints involving a particular group of items.

For stratified sample collection, items are randomly selected from different “merchandise groups” in a store. They are tested in the first stage of the two-stage manual sampling plan to determine if (1) any group has more errors than any other and (2) the sample taken in the first stage meets accuracy requirements. This method should be modified depending on the marketing practices of the store in which it is used (e.g., if you are in a department store, there may be fewer groups to sample from, or the list provided below may not include the types of groups typically encountered in a hardware superstore). The next example shows how to conduct a stratified sample and how it is used, but it should not be the sole basis for sample collection because a specific list of items does not look at the store as a whole. Focusing on specific merchandise groups takes time, but this may be necessary when investigating a complaint or following up on a prior noncompliance. Select only one item from each brand or product from a display that has two or more items of the same product, size, and price displayed side by side if they are the same price.

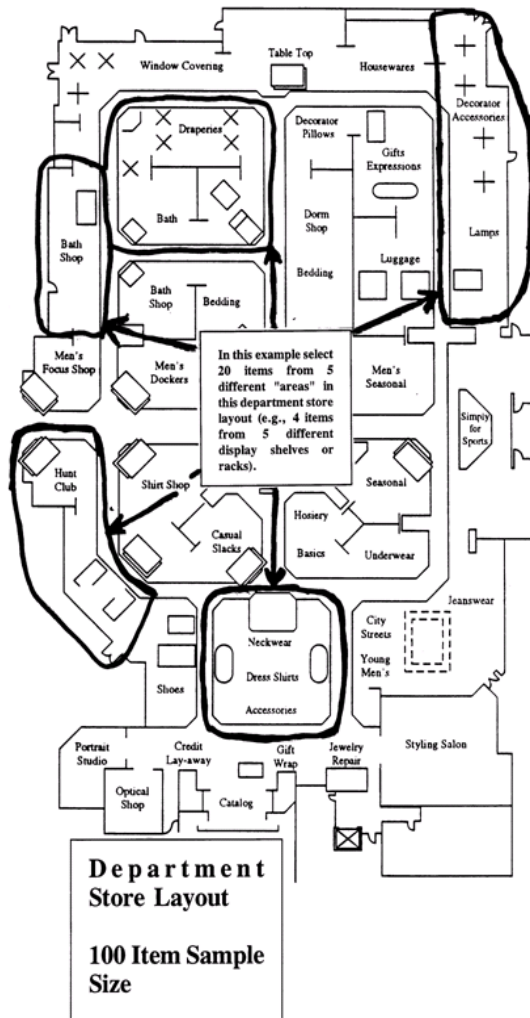

Figure 4. Stratified Sample Collection

RANDOMIZED SAMPLE COLLECTION

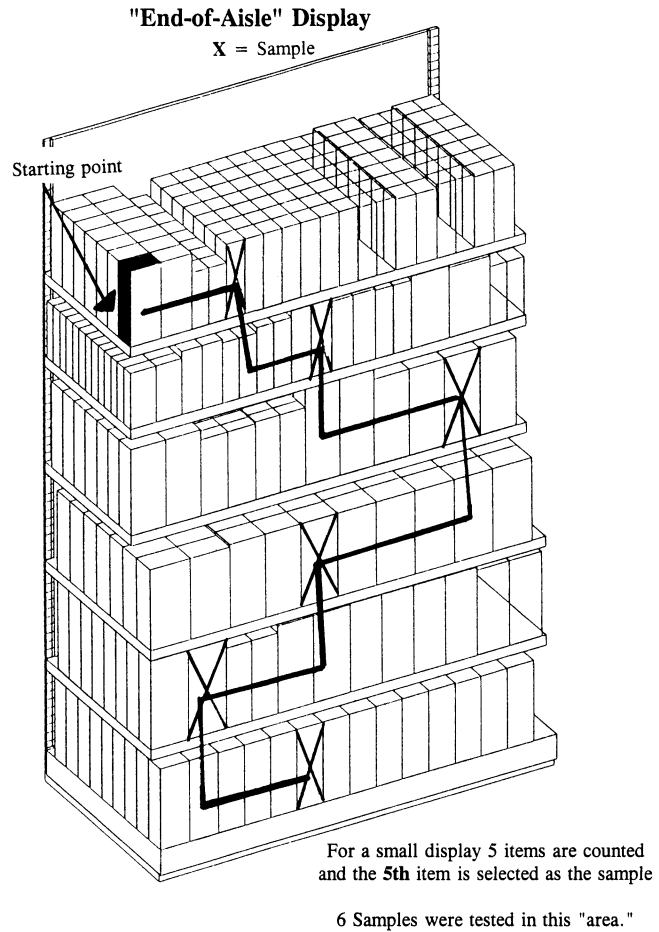

Figure 5. Randomized Sample Collection

Sample Size. – In this example, a large food store is inspected using a two-stage sampling plan (50 items/100 total items). The inspection begins with an initial sample of 50 items (see Column 1. Type of Store for All Other Retail Stores and Column 2. Sample Sizes in Table 1).

Stratified Sample Collection. – Select 50 items from the merchandise groups listed below (provided as examples only; stores may have other groups that should be included). This procedure allows you to focus on specific merchandise groups to determine if errors are indeed occurring in groups where they are thought to occur most frequently (e.g., sale and direct delivery items).

7.3.2.1. Example 2. Two-Stage Manual Inspection using the Stratified Sampling Procedure.

If there is an insufficient number of items in any merchandise group, or if the group of items is not available, increase the number of “randomized” items selected from the overall inspection lot to obtain a total of 50 items. As marketing practices evolve, these groups may change as well. You may substitute “other” or new merchandise groups for any of those listed below (e.g., you may have identified errors in the “health and beauty aids” section or on “manager specials” during a previous inspection, so samples from these groups may be substituted for any of the groups listed below). Model “Price Verification Tally Sheets” in Section 14. Model Forms for Price Verification Inspections are provided for your use with the test procedures to keep track of the number of items selected.

First-Stage: 50 items. – Use the “randomized” sample collection procedures described in 7.3.1. Randomized Sample Collection to select the following items. These sample collection procedures simplify the inspection process and ensure that samples are collected as randomly as possible.

Examples:

- Twenty-five “Regular Priced” items. Select one or two items at random from different shelves in each “area” or limit your sampling to shelves in one-half the “areas” in the store, and
- Twenty-five Items. Select a total of 25 items. Include several items from any of the following merchandise groups:
 - “Direct-Store-Delivery (DSD)” items. If the store allows vendors to price DSD items, include those items in the sample.
 - “End-of-Aisle” or “Tie-In-Display” items. This group can include both regular and sale-priced items.
 - “Advertised Sale” items. Use the store’s sales brochure or newspaper advertisements to identify sale items.
 - “Special” items. This includes any item with a reduced price (e.g., items on “special” including “cents-off” or “percentage-off” items, 2-for-the-price-of-1 specials, manager and in-store specials, or discontinued items). Items typically discounted on a percentage basis include a manufacturer’s product line, greeting cards, magazines, or books.
 - “PLU” items. This includes both regular and sale priced items offered in the produce, bakery, or bulk food departments and over scales at the direct sale counters. For direct service departments (e.g., produce, deli, specialty meats, etc.), select products at random (include some sale or special prices) and enter the code in the scale ^[NOTE 1, page 210] to verify that the coded price matches the advertised price ^[NOTE 2, page 210].
 - “Store-coded” items. This includes items offered in the produce, bakery, or meat departments that have labels with the UPC symbol generated by scales and printers in the store. For store-coded items, scan the item and determine if the total price and identity on the label are accurately read by the point-of-sale system. When checking “store-coded” items from the meat or other departments, remember that a “UPC symbol” on a random weight label is read by a scanner to obtain the total price and identity. The price is not stored in the point-of-sale database.
 - “Other” items. This category is included to provide flexibility in selecting a sample so that “seasonal” items, or products unique to the store or local market, can be included. Both regular and sale-priced items can be included in this category.

NOTE 1: *Some scales or point-of-sale systems do not display or record the unit price associated with the PLU unless weight is on the scale. For these devices, a 1 lb (or 1 kg) standard is placed on the scale load-receiving element. Some systems automatically deduct tare, so make sure this does not affect the price indication.*

NOTE 2: *When a not-on-file item is found, another item is selected at random to replace it in the sample. A “not-on-file” item is not an error unless you determine (e.g., by conducting a test purchase or by asking the check-out clerk to determine the price of the item using the store’s customary procedures) that the price “charged” for the item is incorrect. If the price determined is not correct, the error is included in the total.*

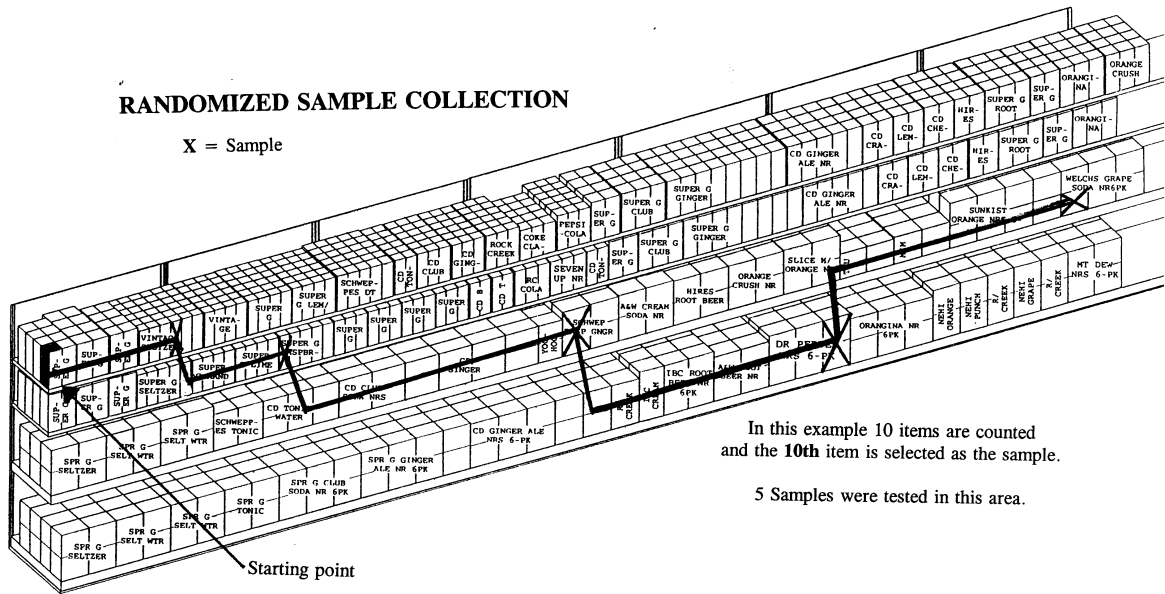

Figure 6.

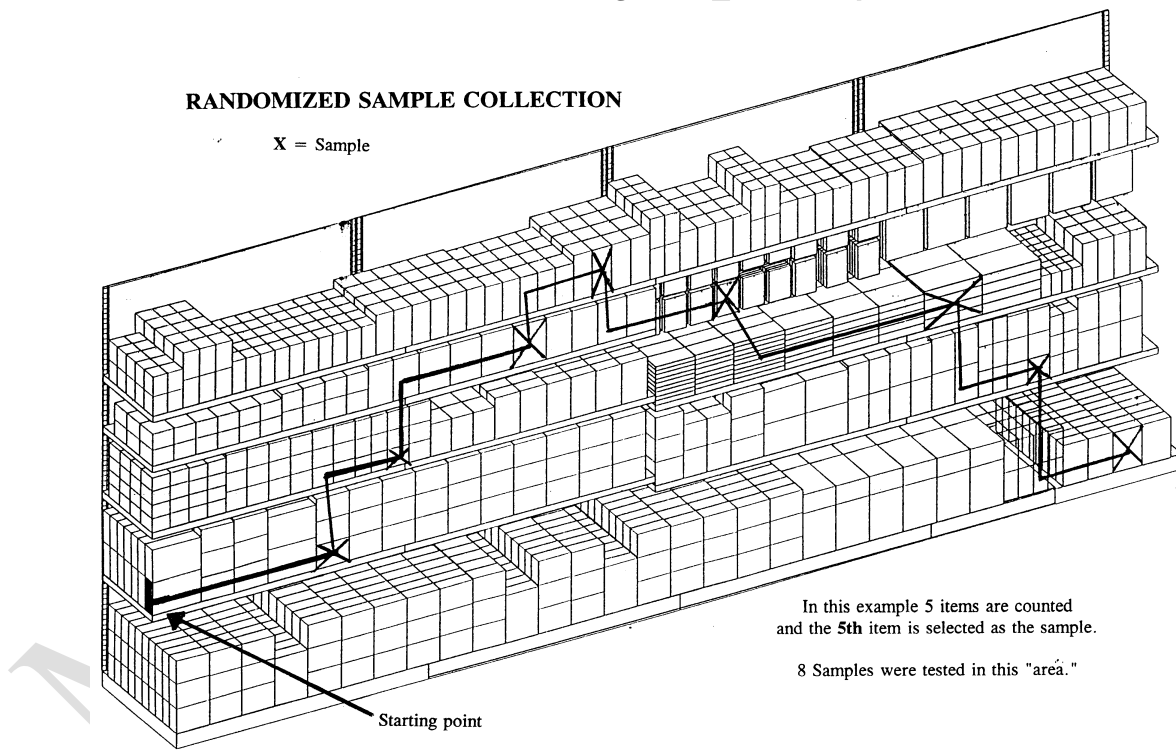

Figure 7.

Identify the item on an inspection report (e.g., record a brief description, item number, shelf, or advertised price and aisle location. The aisle location makes it easy to find the product if errors are found and to re-shelve the items). As items are selected, use the "Price Verification Tally Sheet," or other means, to keep track of the number of items collected. (See Section 14. Model Forms for Price Verification Inspections. The "Model Price Verification Reports" in this proposal were developed with the assumption that it is only necessary to record information of items found with price errors, not all items verified. This reduces paperwork and saves time.) Either use a hand-held scanning device or take the items to a cash register,

verify the prices by scanning the items or entering a PLU code into the register and printing a receipt. The prices “charged” at the register are then compared to the advertised price of each item. For large or perishable items, record the identity, UPC Code, location, and price and manually enter the UPC number into the register to verify the price. However, this method is subject to recording and key entry errors.

Evaluation of Results on First-Stage.

See Section 9. Evaluation and Inspection Results for guidance on which errors are considered violations: One error in a 50-item sample is permitted. If not more than one error is found and verified, the store passes; if 3 items are found in error in the first 50 items, the store fails and the inspection is complete.

If two errors are found, collect 50 more items using the randomized sampling procedures and verify a total of 100 items. If errors were found in any specific merchandise group (or groups) of items (e.g., direct-store-delivery items, PLU codes, or specials), the additional 50 items should include items from those merchandise groups.

Accuracy.

Refer to Column 4 in Table 1. Samples, Sample Collection, and Accuracy Requirements. The required accuracy is 98 % on the 100-item sample (that is, at most two errors are permitted on a 100-item sample). If more than two errors are found and verified, the store does not meet the accuracy requirement.

NOTE: The “randomized” and “stratified” sample collection procedures in this section are intended for use in routine inspections to determine how a store is maintaining price accuracy on all of the items it offers for sale. If you use these sampling procedures in routine inspections and uncover a significant number of errors in a particular merchandise group (e.g., a significant number of the pricing errors are found with “advertised sale item” items), a randomized sample can be collected entirely within this specific merchandise group. For example, if the error rate for “advertised specials” is higher than the rate for regular priced items, a more focused inquiry to determine if there is a significant error rate in this merchandise group may be justified. If several “advertised specials” have been the subject of consumer complaints, or if they are repeatedly found to be in error during routine inspections, then a randomized sample can be limited to the “advertised specials” merchandise group. In this case, a randomized sample (e.g., a 50/100 item two-stage approach) is taken from all of the “advertised sale items” offered for sale in the store or in a specific “area.” The results of this sample are applicable only to the “advertised specials” group and not to all items in the store.

7.4. Procedures for Test Purchases, Investigation of Consumer Complaints, and for Verification of Manually Entered Prices.

7.4.1. Procedure. – This procedure may be used to (1) investigate consumer complaints, (2) determine if a store has corrected a pricing error after being notified that an error occurred, or (3) determine if manually keyed-in prices or PLU codes are accurate.

NOTE: When verifying manual price entries, store management is typically not notified of the test until the items have been totaled and the transaction completed.

- (a) Do not alert the clerk to the fact that the test purchase procedure is being conducted. Do not ask questions concerning any errors that you observe or offer any information if asked the price of an item, in cases where the item price is illegible, or where the item is not on file.
- (b) Use the “randomized” sampling procedures to select a sample of 10 to 50 items that includes regular and sale priced items, PLU items, and advertised specials from various “areas.” It is acceptable to purchase only one or just a few items if you are investigating a complaint on a specific item. Record the name and identity of the product, as well as the labeled or advertised price, for each item.

- (c) Proceed through a check-out as if you were a customer and pay for the purchase. Obtain the original sales receipt, and compare the price charged with the labeled or advertised price for each item. Record the time of day, lane number, and the identity of the checker. Before leaving the store, determine if any errors have occurred. Identify yourself and inform the store management that a test purchase was conducted and report the results. (In many instances, the store will credit back all of the items and refund the test purchase money.) Record the information on the test report form and determine the cause of the error (e.g., operator error, mislabeling, or incorrect price sign).

7.4.2. Alternative Procedure - Consumer Complaints. – Complaints can be investigated by using any of the test procedures described above or by verifying only the price of the item or items subject to the complaint. If the complaint is valid, you can limit your inspection to the items described in the complaint or you may conduct a complete inspection.

7.4.3. Evaluation of Results. – The errors for items verified using these procedures should be evaluated according to Sections 9. Evaluation of Inspection Results and 10. Accuracy Requirements.

Section 8. Documentation of Findings

Several examples of Model Price Verification Reports are contained in pages 219 to 224. These forms were developed so that you only have to record the items found with price errors.

- (a) Record errors and provide information on the cause, if determined. Indicate if the errors are considered to be violations, if stop-sale orders were issued, or if the violation was corrected.
- (b) Notices of violations or other significant comments (e.g., warnings or violations ordered corrected) should always be included on the test form.
- (c) Cash register receipts on verified items should be retained and attached to the inspection report as evidence.
- (d) Printed advertisements and sales flyers should be retained and attached to the inspection report when errors are found in these categories.

Section 9. Evaluation of Inspection Results

9.1. Definition of Errors. – An error found to result from any of the following causes should not be considered a violation for enforcement purposes:

- (a) An intentional undercharge if documentation or confirmation of the date and time of the price change is provided at the time of the inspection.
- (b) An error caused by a mistake made in any kind of advertisement (e.g., newspaper, printed brochure, or radio or television advertisement) if the store has placed a notice adjacent to the item indicating that a mistake occurred in the advertisement.
- (c) An error obviously caused by a price label that is missing or that has fallen off the shelf, or the item or the price label or sign has obviously been relocated by an unauthorized person.
- (d) A “not-on-file” item is not an error unless you determine that the price “charged” for the item is incorrect (e.g., by conducting a test purchase or by asking the check-out clerk to determine the price of the item using the store’s documented or customary procedures. If the price determined is incorrect, it is considered an error.)

NOTE: *It is recommended that you work with the store representative to identify the cause of any error and note the problem/cause on the report. This may not change your findings, but will help to identify problems related to*

staff errors, failure to follow through on established store pricing procedures, data entry errors, or failure of management to provide correct written data, etc. The supporting information will help with enforcement decisions as well as in-house monitoring of product pricing.

9.2. Computing Sample Errors. – The following formulas are used to determine sample error and the overcharge to undercharge ratio:

- (a) Adjust the total sample by subtracting any items or errors specified in 9.1. Definition of Errors.
- (b) To compute the sample error, divide the number of errors by the total sample size to obtain the error in percent.

For example: a sample of 100 items is verified; 3 overcharges and 1 undercharge are found for a total of 4 errors:

$$4 \div 100 = 4 \% \text{ sample error.}$$

- (c) To compute the ratio of overcharges to undercharges (used on large samples and in follow-up activities), total the overcharges/undercharges and compare the numbers:

$$3 \text{ overcharges}/1 \text{ undercharge} = \text{a 3 to 1 ratio.}$$

Section 10. Accuracy Requirements

10.1. Accuracy Requirements. – Accuracy information, based on a percentage of errors found in a sample and the ratio of overcharges to undercharges, constitutes useful criteria for evaluating the “pricing integrity” of the store. Both overcharges and undercharges should be considered as errors in taking lower level enforcement actions since (1) either type of error misrepresents the price of the item; and (2) the occurrence of any error in a randomized sample may indicate poor pricing practices that would result in errors where additional items were sampled. For higher levels of enforcement only overcharges are considered.

10.2. Accuracy. – The accuracy requirement for a sample must be 98 % or higher to “pass” a single inspection. See Column 4, Accuracy Requirements, in Table 1. Samples, Sample Collection, and Accuracy Requirements.

10.3. Ratio of Overcharges to Undercharges. – With large sample sizes, overcharges should not exceed the undercharges. A high rate of overcharges to undercharges (2 to 1, or 3 to 1) may indicate systematic problems with a store’s pricing practices.

NOTE: As the history of store compliance develops, the number of overcharges and undercharges may be evaluated to determine if systematic errors or other problems exist. This ratio should be maintained when at least 10 errors are found over several inspections, or in a single large sample size (e.g., the results of several 100-item inspections collected over a period of time or if 1000 items are sampled in one inspection.)

Table 2. Price Errors
(This table shows the percentage of errors in different sample sizes)

| No. of Errors | Percentage of Errors Sample Size | | | | | |
|---------------|-------------------------------------|------|------|--------|--------|--------|
| | 25 | 50 | 100 | 150 | 200 | 300 |
| 1 | 4 % | 2 % | 1 % | 0.67 % | 0.50 % | 0.33 % |
| 2 | 8 % | 4 % | 2 % | 1.33 % | 1.00 % | 0.67 % |
| 3 | 12 % | 6 % | 3 % | 2.00 % | 1.50 % | 1.00 % |
| 4 | 16 % | 8 % | 4 % | 2.67 % | 2.00 % | 1.33 % |
| 5 | 20 % | 10 % | 5 % | 3.33 % | 2.50 % | 1.67 % |
| 6 | 24 % | 12 % | 6 % | 4.00 % | 3.00 % | 2.00 % |
| 7 | 28 % | 14 % | 7 % | 4.67 % | 3.50 % | 2.33 % |
| 8 | 32 % | 16 % | 8 % | 5.33 % | 4.00 % | 2.67 % |
| 9 | 36 % | 18 % | 9 % | 6.00 % | 4.50 % | 3.00 % |
| 10 | 40 % | 20 % | 10 % | 6.67 % | 5.00 % | 3.33 % |

NOTE: Random pricing errors are to be expected, but the ratio of overcharges to undercharges will rarely be exactly 1 to 1 (e.g., of 10 errors, 5 overcharges and 5 undercharges); the ratio will likely vary both ways over several inspections. If a store has more overcharges than undercharges (e.g., 2 to 1, or 3 to 1), it may indicate that the store is not following good pricing practices, but enough errors must be present in order to make this determination. (Consider the example of 12 pricing errors consisting of 8 overcharges and 4 undercharges: the ratio of overcharges to undercharges is 2 to 1. Similarly, 10 pricing errors consisting of 6 overcharges and 4 undercharges correspond to a ratio of 1.5 to 1; since all decimal values are truncated to whole numbers, 1.5 is truncated to 1, and the ratio becomes 1 to 1.)

The one-to-one ratio should be applied to any sample size if at least 10 errors are present. For example, if 1000 items are verified and 10 items are found in error, the sample has an accuracy of 99 %. However, if 9 of the 10 errors are overcharges (i.e., a ratio of 9 overcharges to 1 undercharge), the store should be considered to have poor pricing practices or other problems; if 100 items are verified and a 90 % accuracy is found, 10 items in error not meeting the overcharge to undercharge ratio can be used in enforcement action as evidence of poor pricing practices.

Section 11. Enforcement Procedures

11.1. Enforcement Steps.

- (a) Compliance is based on the accuracy found on a sample collected according to this procedure.
- (b) Errors should be corrected immediately, or if the correction cannot be made immediately, a stop-sale order shall be issued before you leave the business. If the errors are not corrected in your presence, a follow-up

inspection may be made later in the day or the following day to ensure the store has corrected the error. If a store fails to correct the error by that time, higher level enforcement action should be taken.

- (c) Enforcement action for large monetary errors on individual items, confirmed overcharges on items verified in response to complaints, or errors found on follow-up inspection of items ordered corrected, should be taken independently from any sample, giving consideration to the magnitude of the violation, corrective action by the establishment, and any other relevant information. Action may be initiated at any time in the inspection process based on the facts of the individual case.
- (d) Overcharges and undercharges are used to determine lower levels of enforcement actions, but higher levels of enforcement action (e.g., fines or penalties) are taken only on the overcharges found in the sample.

(Amended 2001)

***NOTE:** Many computer systems do not allow for the immediate correction of errors in the database. Downloading information throughout the day may not be possible. Therefore, for the purposes of this section, “immediate” correction of errors may entail the removal or correction of problem signs, manually changing marked prices, or communicating notice of the corrected price to all applicable stores through facsimile, e-mail, or any other appropriate medium to ensure that consumers are charged the correct price.*

11.2. Model Enforcement Levels.

These recommendations do not modify the enforcement policy of any jurisdiction unless adopted by that jurisdiction.

- (a) **Ninety-Eight Percent or Higher.** – If price accuracy is 98 % or higher on a sample of 50 or more items, and if overcharges do not exceed undercharges on sample sizes of 100 or more items, and the store is on a normal inspection frequency:
 - (1) a notice of noncompliance is issued on violations, and the store is maintained on a normal inspection frequency; or
 - (2) if the store is on increased inspection frequency, it remains on this frequency until inspection results conform to Terms of Increased Inspection Frequency.
- (b) **Less Than Ninety-Eight Percent.** – If price accuracy is less than 98 % on a sample of 50 or more items and if overcharges do not exceed undercharges on large sample sizes, and the store is on normal inspection frequency:
 - (1) A notice of noncompliance is issued and the store is placed on an increased inspection frequency.
 - (2) A second inspection should be conducted within 30 business days. If the price accuracy then is not 98 % or higher, a warning is issued.
 - (3) A third inspection should be made within 60 business days. If the price accuracy is again less than 98 %, higher level enforcement action should be taken.

(Amended 2001)

If the store is on increased inspection frequency, a warning should be issued and the store re-inspected within 30 business days. If price accuracy is less than 98 %, higher levels of enforcement action should be taken.

(Amended 2001)

Examples:

For the 100-item sample size:

- If 100 items are verified and three overcharges are found in the sample, the error rate is 3 %. In this example, higher levels of enforcement action should be taken.
 - If 100 items are verified and three overcharges and two undercharges are found, the error rate on the sample is 5 %, but overcharges are 3 %. In this example, higher levels of enforcement action should be taken.
 - If 100 items are verified and two overcharges and three undercharges are found, the error rate is still 5 %, but overcharges are only 2 % of the sample. In this example, a lower level enforcement action would be taken.
- (c) **Terms of Increased Inspection Frequency.** – When a store is on increased inspection frequency, it shall remain at that frequency until two consecutive inspections reveal an accuracy of 98 % or higher.
- (d) **Higher Levels of Enforcement Action.** – Overcharges and undercharges are used to determine lower levels of enforcement actions, but higher levels of enforcement action (e.g., fines or penalties) are taken only on overcharges. A store’s history of error rates, the time it takes a store to correct the errors, the difference in inaccuracy rates found between “regular” and “sale” priced items, the ratio of overcharges to undercharges, a record of valid consumer complaints, and the magnitude of the error(s) may be used to support enforcement action.

Section 12. Post-Inspection Tasks

- (a) You should meet with the store representative to review your findings. Have the inspection report completed prior to the meeting and be prepared to briefly summarize your findings and recommended actions, and provide a copy to the store representative.
- (b) Return borrowed safety, sanitation, and/or test equipment.
- (c) If you removed items from display, ensure that the items are returned to their proper location on the store shelves unless the representative requests to have the items returned by a store employee, which is permitted.
- (d) Advise the representative of your findings. Explain any violations and errors. Explain any orders issued and be sure the individual acknowledges understanding of what corrective action is expected, if any.
- (e) If necessary, describe the implications of the inspection results and advise the store of the action that you intend to take. If an increased inspection frequency is called for due to the accuracy level found during the inspection, advise the firm that re-inspections will be made, but do not indicate when they may occur.

Section 13. Supervisory Activities

13.1. Baseline Surveys. – Price verification programs require management support so that the program’s objectives and desired benefits can be incorporated into the enforcement agency’s work plans and budget. Surveys to measure pre- and post-implementation accuracy should be used to establish a base from which to measure whether a cost/benefit has been obtained.

13.2. Follow-up Inspections. – Inspections that reveal errors exceeding the accuracy requirements recommended above must include follow-up action to ensure that the store fulfills its obligations regarding accurate prices.

13.3. Management Information Systems. – To ensure adequate control and follow-up, a database should be established in each jurisdiction to provide information on every store, including:

For stores:

- store name
- address
- telephone
- type of store
- frequency of inspection
- sample size
- accuracy
- number of overcharges
- dollar value of overcharges
- number of undercharges
- dollar value of undercharges
- average money value of undercharges
- ratio of overcharges to undercharges

For program review:

- total number of undercharges
- total dollar value of undercharges
- average dollar value of undercharges
- percent undercharges of total
- ratio of overcharges to undercharges
- total error in percent
- accuracy levels of stores
- store type
- total stores tested
- total stores tested (each type)
- total items tested
- total number of overcharges
- total dollar value of overcharges
- average dollar value of overcharges
- percent of overcharges of total

Section 14. Model Forms for Price Verification Inspections

These models can be used to develop formal report forms, or they can be copied and used as worksheets for conducting inspections:

- (a) **Sample Tally Sheets:** These forms can help you keep track of the number of items verified. They provide spaces to record the item's display location (e.g., aisle or department), a description of the item, and the shelf or advertised price. The worksheets are set up for the stratified sample collection described above to help identify the types of products to select.
- (1) Price Verification Tally Sheet – Food Stores. (See page 219.)
 - (2) Price Verification Tally Sheet – Department Stores. (See page 220.)
- (b) **Model Inspection Form I:** This can be used to document violations and record findings. A completed sample is provided.
- (1) Price Verification Report I – sample blank form. (See page 221.)
 - (2) Price Verification Report I – completed sample form. (See page 222.)
- (c) **Model Inspection Form II:** This can be used in stores where a hand-held scanning device is not available, or when it is inconvenient to take items (e.g., a large ladder in a hardware store) to a check-out register to verify the price. You can record an identity, the UPC or PLU code, and advertised price so that you can manually enter the codes to verify the price. The form can also be used to record findings. A completed sample is provided.
- (1) Price Verification Report II – sample blank form. (See page 223.)
 - (2) Price Verification Report II – completed sample form. (See page 224.)

Price Verification Tally Sheet - Food Stores

| | Item | Location | UPC/Identity | Shelf Price |
|---------------------------------------|-------------|-----------------|---------------------|--------------------|
| “End of Aisle” or “Tie-In Display” | 1. _____ | 1. _____ | 1. _____ | 1. _____ |
| | 2. _____ | 2. _____ | 2. _____ | 2. _____ |
| | 3. _____ | 3. _____ | 3. _____ | 3. _____ |
| | 4. _____ | 4. _____ | 4. _____ | 4. _____ |
| “PLU or Coded” Items | 6. _____ | 6. _____ | 6. _____ | 6. _____ |
| | 7. _____ | 7. _____ | 7. _____ | 7. _____ |
| | 8. _____ | 8. _____ | 8. _____ | 8. _____ |
| | 9. _____ | 9. _____ | 9. _____ | 9. _____ |
| “Advertised Sale” Items | 10. _____ | 10. _____ | 10. _____ | 10. _____ |
| | 11. _____ | 11. _____ | 11. _____ | 11. _____ |
| | 12. _____ | 12. _____ | 12. _____ | 12. _____ |
| | 13. _____ | 13. _____ | 13. _____ | 13. _____ |
| | 14. _____ | 14. _____ | 14. _____ | 14. _____ |
| | 15. _____ | 15. _____ | 15. _____ | 15. _____ |
| | 16. _____ | 16. _____ | 16. _____ | 16. _____ |
| | 17. _____ | 17. _____ | 17. _____ | 17. _____ |
| Items on “Special” | 18. _____ | 18. _____ | 18. _____ | 18. _____ |
| | 19. _____ | 19. _____ | 19. _____ | 19. _____ |
| | 20. _____ | 20. _____ | 20. _____ | 20. _____ |
| | 21. _____ | 21. _____ | 21. _____ | 21. _____ |
| “Direct Store Delivery” Items | 22. _____ | 22. _____ | 22. _____ | 22. _____ |
| | 23. _____ | 23. _____ | 23. _____ | 23. _____ |
| | 24. _____ | 24. _____ | 24. _____ | 24. _____ |
| | 25. _____ | 25. _____ | 25. _____ | 25. _____ |
| “Randomly Selected” Items | 26. _____ | 26. _____ | 26. _____ | 26. _____ |
| | 27. _____ | 27. _____ | 27. _____ | 27. _____ |
| | 28. _____ | 28. _____ | 28. _____ | 28. _____ |
| | 29. _____ | 29. _____ | 29. _____ | 29. _____ |
| | 30. _____ | 30. _____ | 30. _____ | 30. _____ |
| | 31. _____ | 31. _____ | 31. _____ | 31. _____ |
| | 32. _____ | 32. _____ | 32. _____ | 32. _____ |
| | 33. _____ | 33. _____ | 33. _____ | 33. _____ |
| | 34. _____ | 34. _____ | 34. _____ | 34. _____ |
| | 35. _____ | 35. _____ | 35. _____ | 35. _____ |
| | 36. _____ | 36. _____ | 36. _____ | 36. _____ |
| | 37. _____ | 37. _____ | 37. _____ | 37. _____ |
| | 38. _____ | 38. _____ | 38. _____ | 38. _____ |
| | 39. _____ | 39. _____ | 39. _____ | 39. _____ |
| | 40. _____ | 40. _____ | 40. _____ | 40. _____ |
| | 41. _____ | 41. _____ | 41. _____ | 41. _____ |
| 42. _____ | 42. _____ | 42. _____ | 42. _____ | |
| 43. _____ | 43. _____ | 43. _____ | 43. _____ | |
| 44. _____ | 44. _____ | 44. _____ | 44. _____ | |
| 45. _____ | 45. _____ | 45. _____ | 45. _____ | |
| 46. _____ | 46. _____ | 46. _____ | 46. _____ | |
| 47. _____ | 47. _____ | 47. _____ | 47. _____ | |
| 48. _____ | 48. _____ | 48. _____ | 48. _____ | |
| 49. _____ | 49. _____ | 49. _____ | 49. _____ | |
| 50. _____ | 50. _____ | 50. _____ | 50. _____ | |

Price Verification Tally Sheet - Department Stores

| | Identity | Location | Advertised |
|---------------------------------------|-----------------|-----------------|-------------------|
| “End of Aisle” or “Tie-In Display” | 1. _____ | 1. _____ | 1. _____ |
| | 2. _____ | 2. _____ | 2. _____ |
| | 3. _____ | 3. _____ | 3. _____ |
| | 4. _____ | 4. _____ | 4. _____ |
| | 5. _____ | 5. _____ | 5. _____ |
| “Advertised Sale” Items | 6. _____ | 6. _____ | 6. _____ |
| | 7. _____ | 7. _____ | 7. _____ |
| | 8. _____ | 8. _____ | 8. _____ |
| | 9. _____ | 9. _____ | 9. _____ |
| | 10. _____ | 10. _____ | 10. _____ |
| | 11. _____ | 11. _____ | 11. _____ |
| | 12. _____ | 12. _____ | 12. _____ |
| | 13. _____ | 13. _____ | 13. _____ |
| | 14. _____ | 14. _____ | 14. _____ |
| | 15. _____ | 15. _____ | 15. _____ |
| Items on “Special” | 16. _____ | 16. _____ | 16. _____ |
| | 17. _____ | 17. _____ | 17. _____ |
| | 18. _____ | 18. _____ | 18. _____ |
| | 19. _____ | 19. _____ | 19. _____ |
| | 20. _____ | 20. _____ | 20. _____ |
| | 21. _____ | 21. _____ | 21. _____ |
| | 22. _____ | 22. _____ | 22. _____ |
| | 23. _____ | 23. _____ | 23. _____ |
| | 24. _____ | 24. _____ | 24. _____ |
| | 25. _____ | 25. _____ | 25. _____ |
| “Randomly Selected” Items | 26. _____ | 26. _____ | 26. _____ |
| | 27. _____ | 27. _____ | 27. _____ |
| | 28. _____ | 28. _____ | 28. _____ |
| | 29. _____ | 29. _____ | 29. _____ |
| | 30. _____ | 30. _____ | 30. _____ |
| | 31. _____ | 31. _____ | 31. _____ |
| | 32. _____ | 32. _____ | 32. _____ |
| | 33. _____ | 33. _____ | 33. _____ |
| | 34. _____ | 34. _____ | 34. _____ |
| | 35. _____ | 35. _____ | 35. _____ |
| | 36. _____ | 36. _____ | 36. _____ |
| | 37. _____ | 37. _____ | 37. _____ |
| | 38. _____ | 38. _____ | 38. _____ |
| | 39. _____ | 39. _____ | 39. _____ |
| | 40. _____ | 40. _____ | 40. _____ |
| | 41. _____ | 41. _____ | 41. _____ |
| | 42. _____ | 42. _____ | 42. _____ |
| | 43. _____ | 43. _____ | 43. _____ |
| | 44. _____ | 44. _____ | 44. _____ |
| | 45. _____ | 45. _____ | 45. _____ |
| | 46. _____ | 46. _____ | 46. _____ |
| | 47. _____ | 47. _____ | 47. _____ |
| | 48. _____ | 48. _____ | 48. _____ |
| | 49. _____ | 49. _____ | 49. _____ |
| | 50. _____ | 50. _____ | 50. _____ |

Price Verification Report I

Page ___ of ___

Inspection: 1st 2nd 3rd **Frequency:** Normal Increased **Type:** Stratified Automated Randomized **Complaint:**

| Location of Test (Store Name, Address, County, ZIP Code) | | Date: | Telephone: | | |
|--|---|---------------|----------------|-----------|--|
| | | Manager: | Type of Store: | | |
| Identity, Brand Name, Item or Style Number | Number of Items, Size, Location in Store, or UPC Code | Offered Price | Price Charged | Error (±) | |
| 1. | | | | | |
| <input type="checkbox"/> Stop Sale Issued <input type="checkbox"/> Corrected | | Comments: | | | |
| 2. | | | | | |
| <input type="checkbox"/> Stop Sale Issued <input type="checkbox"/> Corrected | | Comments: | | | |
| 3. | | | | | |
| <input type="checkbox"/> Stop Sale Issued <input type="checkbox"/> Corrected | | Comments: | | | |
| 4. | | | | | |
| <input type="checkbox"/> Stop Sale Issued <input type="checkbox"/> Corrected | | Comments: | | | |
| 5. | | | | | |
| <input type="checkbox"/> Stop Sale Issued <input type="checkbox"/> Corrected | | Comments: | | | |
| 6. | | | | | |
| <input type="checkbox"/> Stop Sale Issued <input type="checkbox"/> Corrected | | Comments: | | | |
| 7. | | | | | |
| <input type="checkbox"/> Stop Sale Issued <input type="checkbox"/> Corrected | | Comments: | | | |
| 8. | | | | | |
| <input type="checkbox"/> Stop Sale Issued <input type="checkbox"/> Corrected | | Comments: | | | |

Inspection Results:

_____ (Sample Count) - _____ (#Not on File) = _____ (Adjusted Sample Count [ASC])

_____ (#Errors) ÷ _____ (ASC) = _____ (Error Percentage)

(Accuracy Percentage) = _____ % Overcharges/Undercharges Ratio = _____ : _____

Inspector Name: _____

Time In: _____ Time Out: _____

Comments/Remarks: _____

Report Acknowledgement:

Name/Title: _____

Comments/Remarks: _____

Price Verification Report I (completed sample)

Inspection: [] 1st [] 2nd [] 3rd **Frequency:** [] Normal [] Increased **Type:** [] Stratified [] Automated [] Randomized **Complaint:** []

| Location of Test (Store Name, Address, County, ZIP Code) Barkers Food Store 1361 Macon Street Belle, New Jersey 31756 | | Date: 3/10/95 | Telephone: (301) 555-4868 | | |
|---|---|--|-------------------------------------|--------------|--|
| | | Manager: C. Barker | Type of Store: Food Store | | |
| Identity, Brand Name, Item or Style Number | Number of Items, Size, Location in Store, or UPC Code | Offered Price | Price Charged | Error (±) | |
| 1. Smith Cake Mix | 32 oz. 313461346177 | 3.19 | 4.19 | +1.00 | |
| [<input type="checkbox"/>] Stop Sale Issued [<input checked="" type="checkbox"/>] Corrected | | Comments: Sale sign not removed | | | |
| 2. Natural Fruit Juice | 1 Liter 617369345619 | 2.25 | 2.75 | +.50 | |
| [<input type="checkbox"/>] Stop Sale Issued [<input checked="" type="checkbox"/>] Corrected | | Comments: | | | |
| 3. Clocks Soap | 8oz. 936125376558 | 1.19 | 1.00 | -.19 | |
| [<input type="checkbox"/>] Stop Sale Issued [<input checked="" type="checkbox"/>] Corrected | | Comments: | | | |
| 4. | | | | | |
| [<input type="checkbox"/>] Stop Sale Issued [<input type="checkbox"/>] Corrected | | Comments: | | | |
| 5. | | | | | |
| [<input type="checkbox"/>] Stop Sale Issued [<input type="checkbox"/>] Corrected | | Comments: | | | |
| 6. | | | | | |
| [<input type="checkbox"/>] Stop Sale Issued [<input type="checkbox"/>] Corrected | | Comments: | | | |
| 7. | | | | | |
| [<input type="checkbox"/>] Stop Sale Issued [<input type="checkbox"/>] Corrected | | Comments: | | | |
| 8. | | | | | |
| [<input type="checkbox"/>] Stop Sale Issued [<input type="checkbox"/>] Corrected | | Comments: | | | |

Inspection Results:

100 (Sample Count) - 0 (#Not on File) = 100 (Adjusted Sample Count [ASC])

3 (#Errors) ÷ 100 (ASC) = 3 (Error Percentage)

(Accuracy Percentage) = 97 %

Overcharges/Undercharges Ratio = 2 : 1

Inspector Name: T. Price

Time In: 8:15 Time Out: 9:30

Comments/Remarks: _____

Report Acknowledgement:

Name/Title: Chris Barker

Comments/Remarks: _____

Price Verification Report II

Page ___ of ___

Inspection: 1st 2nd 3rd

Frequency: Normal Increased

Complaint:

| Location of Test (Name, Address, County, ZIP Code) | | | Date: | | | Telephone: | | |
|--|---------------|---------------|-----------------|--|---------------|----------------|-----------------|--|
| | | | Manager: | | | Type of Store: | | |
| Item/Size or Style Number | Offered Price | Price Charged | Price Error (±) | Item/Brand/Description/Code/Size | Offered Price | Price Charged | Price Error (±) | |
| 1. Identity: UPC/PLU: Comments: | | | | 11. Identity: UPC/PLU: Comments: | | | | |
| 2. Identity: UPC/PLU: Comments: | | | | 12. Identity: UPC/PLU: Comments: | | | | |
| 3. Identity: UPC/PLU: Comments: | | | | 13. Identity: UPC/PLU: Comments: | | | | |
| 4. Identity: UPC/PLU: Comments: | | | | 14. Identity: UPC/PLU: Comments: | | | | |
| 5. Identity: UPC/PLU: Comments: | | | | 15. Identity: UPC/PLU: Comments: | | | | |
| 6. Identity: UPC/PLU: Comments: | | | | 16. Identity: UPC/PLU: Comments: | | | | |
| 7. Identity: UPC/PLU: Comments: | | | | 17. Identity: UPC/PLU: Comments: | | | | |
| 8. Identity: UPC/PLU: Comments: | | | | 18. Identity: UPC/PLU: Comments: | | | | |
| 9. Identity: UPC/PLU: Comments: | | | | 19. Identity: UPC/PLU: Comments: | | | | |
| 10. Identity: UPC/PLU: Comments: | | | | 20. Identity: UPC/PLU: Comments: | | | | |

Inspection Results:

_____ (Sample Count) - _____ (#Not on File) = _____ (Adjusted Sample Count [ASC]) Stop-Sale Order Issued?

_____ (#Errors) ÷ _____ (ASC) = _____ (Error Percentage)

(Accuracy Percentage) = _____ % Overcharges/Undercharges Ratio = _____ : _____

Inspector Name: _____

Report Acknowledgement:

Time In: _____ Time Out: _____

Name/Title: _____

Comments/Remarks: _____

Comments/Remarks: _____

Price Verification Report II (completed sample)

Inspection: [] 1st [] 2nd [] 3rd

Frequency: [] Normal [] Increased

Complaint: []

| | | |
|--|--------------------------------|---|
| Location of Test (Name, Address, County, ZIP Code) Mark Downtown Department Store 11650 Main St. Alice, MN 61619 | Date: 3/16/95 | Telephone: (614) 555-6146 |
| | Manager: Jim Chester | Type of Store: Department Store |

| Item/Size or Style Number | Offered Price | Price Charged | Price Error (±) | Item/Brand/Description/Code/Size | Offered Price | Price Charged | Price Error (±) |
|---|---------------|---------------|-----------------|--|---------------|---------------|-----------------|
| 1. Identity: Sony Color TV UPC/PLU: 38569 Comments: Model 6136X | 189.00 | 199.00 | +10.00 | 11. Identity: UPC/PLU: Comments: | | | |
| 2. Identity: Moore Lawn Mower UPC/PLU: 31619 Comments: Shp with bagger | 96.00 | 91.00 | -5.00 | 12. Identity: UPC/PLU: Comments: | | | |
| 3. Identity: Taft Rake UPC/PLU: 39916 Comments: Not on file | 8.99 | | | 13. Identity: UPC/PLU: Comments: | | | |
| 4. Identity: Calendar UPC/PLU: 615191 Comments: | 5.50 | 7.10 | +1.60 | 14. Identity: UPC/PLU: Comments: | | | |
| 5. Identity: UPC/PLU: Comments: | | | | 15. Identity: UPC/PLU: Comments: | | | |
| 6. Identity: UPC/PLU: Comments: | | | | 16. Identity: UPC/PLU: Comments: | | | |
| 7. Identity: UPC/PLU: Comments: | | | | 17. Identity: UPC/PLU: Comments: | | | |
| 8. Identity: UPC/PLU: Comments: | | | | 18. Identity: UPC/PLU: Comments: | | | |
| 9. Identity: UPC/PLU: Comments: | | | | 19. Identity: UPC/PLU: Comments: | | | |
| 10. Identity: UPC/PLU: Comments: | | | | 20. Identity: UPC/PLU: Comments: | | | |

Inspection Results:

50 (Sample Count) - 1 (#Not on File) = 49 (Adjusted Sample Count [ASC]) Stop-Sale Order Issued? []
3 (#Errors) ÷ 49 (ASC) = 6 (Error Percentage)
 (Accuracy Percentage) = 94 % Overcharges/Undercharges Ratio = 2 : 1

Inspector Name: Tim Marlowe
 Time In: 10:25 AM Time Out: 4:45 PM
 Comments/Remarks: _____

Report Acknowledgement:
 Name/Title: Jim Chester, Manager
 Comments/Remarks: _____

NCWM Policy, Interpretations, and Guidelines

Introduction

This section of the handbook includes NCWM interpretations, policies, recommendations, inspection outlines, and information on issues that have come before the Conference. Several sections include information on federal requirements related to the uniform laws and regulations presented in the handbook. The purpose of this section is to assist users in understanding and applying the uniform regulations and to guide administrators in implementing new programs or procedures. The guidelines or recommendations provided should not be construed to redefine any state or local law or limit any jurisdiction from enforcing any law, regulation, or procedure (unless the section describes a specific federal regulation that preempts local requirements).

(Added 1997)

2.1.1. Weight(s) and/or Measure(s).

(L&R, 1985, p. 77)

The measuring elements of a point-of-sale system are “weights and/or measures.” Errors in pricing when found in point-of-sale systems come under “Misrepresentation of Pricing” in the weights and measures law and are under the jurisdiction of weights and measures.

Background

A recommendation was made to change the definition of “weights and measures” in the Uniform Weights and Measures Law to specifically define a scanner or point-of-sale system as under weights and measures jurisdiction.

Several state representatives said that they had enforcement problems when a scanner or point-of-sale system was being used and when the price marked on an item (or on the shelf) was not the same as the price printed on the receipt. These officials believe that unless the law specifically defines these devices as “weights and measures,” they have no jurisdiction over the devices’ function.

The Committee disagreed. The NCWM Uniform Weights and Measures Law has a section that forbids the practice of a different price on the retail shelf as compared with the price provided by a scanner. Section 15 of the Uniform Weights and Measures Law reads:

No person shall misrepresent the price of any commodity or service sold, offered, exposed, or advertised for sale by weight, measure, or count, nor represent the price in any manner calculated or tending to mislead or in any way deceive a person.

This section (plus Section 14 forbidding misrepresentation of quantity), if enacted by a state, already provides enforcement authority over scanners and point-of-sale systems.

In addition, the Committee does not want to set a precedent by listing by name the types of devices that might be considered weights and measures devices. This might provide a potential “loop-hole” for those devices not specifically listed. Finally, the Committee members pointed out that it is the human element (the person reading in data or receiving price updates) that introduces the discrepancies in shelf and receipt prices rather than any inherent incapability of the reading device or scanner. Therefore, it is much more effective to forbid the practice of mispricing rather than focus on a single device or apparatus as the means for obtaining compliance.

2.1.2. Section 19(a), Identity.

(L&R Committee, 1986, p. 143)

Packaged food not containing meat or poultry does not have to have an identity statement if the identity of the commodity can easily be identified through the wrapper or container.

Background

Virginia Weights and Measures recommended revision to Section 19(a) of the Uniform Weights and Measures Law (UWML) to eliminate the exemption of an identity statement from packages when the item “can easily be identified through the wrapper or container.” The Committee is of the opinion that there is merit in retaining the language in Section 19(a) of the Uniform Law. Packages of fresh product packaged in a retail establishment are considered to be packages as long as a price is attached. If the exemption were eliminated, such packages instead of being marked, for example, “12/89 cents” would have to be marked “lemons, 12/89 cents.” It was argued that there could be a problem in deciding whether or not a commodity could “easily be identified” (such as might occur in an ethnic specialty grocery or with an exotic produce item). In researching the issue, the Committee has determined that Title 21, Section 101.100(b)(3) of the Code of Federal Regulations specifically exempts the food identity statement from having to appear “. . . if the common or usual name of the food is clearly revealed by its appearance.” Since no specific problems of enforcement were brought to the attention of the Committee concerning this issue, the Committee recommends no change to Section 19(a) at this time. However, the Committee recommends that Section 3.1. and 4. of the Uniform Packaging and Labeling Regulation be noted as follows:

Section 19(a) of the Uniform Weights and Measures Law, and 21 CFR 101.100(b) (3) for non-meat and non-poultry foods, specifically exempt packages from identity statements if the identity of the commodity “can easily be identified through the wrapper or container.”

2.1.3. Definition of Net Weight.

(L&R, 1987, p. 123)

1. It is the intent of this definition to include truck-loads of commodities, not just packages (“containers”).
2. It is not the intent to define the net weight of packaged goods as requiring dry tare (“. . . excluding . . . substance(s) not considered to be part of the commodity” could just as well be interpreted as excluding liquids not considered part of the commodity at the time of sale).
3. It is also the intent to permit more specific definitions as the occasion warrants (“. . . material(s) . . . not considered . . . part of the commodity” might include dirt or “foreign material” in a commodity).

2.1.4. Offenses and Penalties, Sale of an Incorrect Device.

(L&R, 1987, p. 124)

A jurisdiction seeking to enforce the provision of the Uniform Weights and Measures Law that prohibits the sale of an incorrect device would have to show that the seller knowingly sold or offered for sale for use in commerce an incorrect weight or measure. Under Section 22, a seller would not be responsible for actions taken by the purchaser or distributor, in which the seller did not participate or have prior knowledge. Thus, the seller would not be liable:

- (1) if a purchaser or distributor modified a scale obtained from a seller; or
- (2) if a scale were used in trade after the seller informed the purchaser that the scale was not appropriate for that use.

In cases such as those noted above, the Committee feels that the seller would be protected from prosecution. Only sellers who knowingly violate the provision would be subject to prosecution.

2.1.5. Weight: Primary Mill Paper.

(L&R, 1990, p. 81)

Interpretation

Non-consumer sales of “primary mill paper” were discovered by weights and measures officials to be labeled and invoiced on what was called a “gross weight” basis. Primary mill paper is produced for commercial or industrial companies for subsequent additional processing, such as paper for newspaper or magazine publishers or sanitary tissue manufacturers. The primary mill paper is cut from “parent rolls” but is still a commercial-sized item weighing from several hundred to several thousands of pounds.

The key to understanding the longstanding trade practice is that the purchaser of such paper specifies not only the quality of the paper being purchased, such as the thickness, surface coating, etc., but the purchaser also specifies the core around which the paper is to be wound, the type of overwrap, the number of overwraps, and such other requirements that will ensure receipt of the primary mill paper in proper condition for subsequent processing. The weight of the core and wrapping is approximately 1 % of the gross weight. It is recycled by the purchasers in their own or other paper recovery or reuse systems.

Having reviewed the practices in the industry in the specification and purchasing of primary mill paper, the Committee concludes that the true product is the paper plus the packaging (in order to assure maintenance of quality) and an appropriate core (to ensure a fit on the recipient’s equipment). Therefore, in the Committee’s opinion, the sale of primary mill paper is not at all on a gross weight basis. This is and has been a misnomer. The true identity of the purchased product has been misunderstood by weights and measures authorities, further compounded by the industry use of the term “gross weight.” The product is the primary mill paper plus the core and overwrap specified by the purchaser.

The Committee, therefore, believes that the industry should review its invoicing and labeling to clarify that the weight of the specified product is the weight of the primary mill paper, core, and overwrap. Although this weight is the gross weight of the entire item as produced and shipped, it is the net weight of the item as specified by the purchaser.

This interpretation applies only to primary mill paper and is not intended to be applied to all non-consumer products ordered by specification; it is a narrow interpretation applying to the specific method of sale in this trade where the service of packaging and the packaging is part of the purchase.

2.2.1. Gift Packages.

(Resol. 1975, p. 237)

See also Interpretation 2.2.8.

Interpretation

Seasonal gift packages are often put up in retail stores in baskets and other decorative containers using cellophane or other clear flexible wrap to enclose a number of similar or dissimilar prepackaged items (for example: cheese, jellies, sausages, wine, fruit, etc.). The resulting combination or variety package must have a legally conforming label including the net contents statement.

2.2.2. Sand.

(L&R, 1978, p. 151)

Interpretation

Sand put up in permanent wooden bins is a consumer package and must be labeled with all mandatory information as required by the Uniform Packaging and Labeling Regulation.

Background

The State of Hawaii raised the issue of the sale of sand in permanent wooden bins and sold by price per cubic measure. The Committee agrees with Hawaii that the sale of sand in this manner is subject to the Uniform Packaging and Labeling Regulation, under the definition of “Consumer Package” (Section 2.2. of the Uniform Packaging and Labeling Regulation) and that no further action is needed.

2.2.3. Sold by $\frac{4}{5}$ Bushel.

(L&R, 1974, p. 220)

Interpretation

The trade practice of crating citrus fruit in $\frac{4}{5}$ bushel units is a long-standing one. It is not intended to be a consumer package. If offered as a consumer package, the general consumer usage and trade custom in the particular state would have to be explored:

Section 6.10.(b)(1) of the Uniform Packaging and Labeling Regulation would permit a declaration employing different fractions in the net quantity declaration other than those permitted under Section 6.10.(b) if there exists a firmly established practice of using $\frac{4}{5}$ bushel in consumer sales and trade custom.

Background

It has been called to the attention of the Committee that certain commodities are being sold to consumers in “unacceptable” fractional units of dry measure in violation of Section 6.10. of the Uniform Packaging and Labeling Regulation. Specifically, the Committee has been asked for an interpretation as to whether the packaging of oranges in a $\frac{4}{5}$ bushel, which is later sold unweighed to a consumer, is a violation of the binary submultiple principle as implied in Section 6.10.(b). Some Committee members asserted that a clear exception exists under Section 6.10.(b)(1) which applies to this long established tradition of crating citrus fruit in $\frac{4}{5}$ of a bushel. Approximately 85 % of this fruit is sold by this trade practice. Additionally, it was asserted that the packager never intended the $\frac{4}{5}$ bushel to be a consumer package, but if the $\frac{4}{5}$ bushel of citrus fruit is sold to consumers, this would be a matter between the appropriate state or local official and the retailer.

The consensus of the Committee is that this action of the packagers is not in violation of the indicated section.

2.2.5. Lot, Shipment, or Delivery.

(L&R, 1981, p. 95)

Policy

The requirements for the average package net contents to meet or exceed the labeled declaration may be applied to production lots, shipments, or deliveries. Shipments or deliveries are smaller collections of packages than production lots that may or may not consist of mixed lot codes.

Emphasis in inspection activities should be placed on warehouse and in plant testing without neglecting retail consumer protection.

Background

The Committee heard a petition from the California Brewers Association to define a lot as:

...a selection of containers under one roof produced by a single company of the same size, type and style, manufactured or packed under similar conditions with a minimum number to be equivalent to one production line shift.

The intention of the petition is to focus Weights and Measures enforcement on production lots as opposed to small collections of packages on retail shelves, because the production lot is under the control of the packager.

An alternative proposal was made that would require mingling of lot and date codes in package inspection at warehouse locations.

The Committee has reviewed the proposals in light of Section 7.6. and Section 12.1. of the Uniform Packaging and Labeling Regulation which refers to “shipment, delivery, or lot.” If the petition is approved, the terms “shipment” and “delivery” would have to be dropped from this Uniform Regulation.

The Committee recognizes the inherent value of in-plant and warehouse inspection and is of the opinion that, wherever possible, such inspections should be carried out. At the same time, the Committee recognizes the need for the state and local weights and measures officials to protect the consumer at the level where the ultimate sale is made. Therefore, the Committee recommends no change to the Uniform Regulation.

The Committee looks forward to the work of the Special Study Group on Enforcement Uniformity of the NCWM which will be exploring the mechanisms that might be instituted to make in-plant inspection workable.

2.2.6. Aerosols and Similar Pressurized Containers.

(L&R, 1976, p. 248)

See also Guideline 2.2.7.

Interpretation

It is the opinion of the NCWM that an FDA opinion as expressed in the Fair Packaging and Labeling Act Manual Guide FDA 7563.7, not objecting to volume declarations on aerosol products, does not supersede or preempt state requirements that aerosols be labeled by net weight.

Background

The Department of Commerce through the Office of Weights and Measures of the National Institute of Standards and Technology, under its statutory responsibility for “cooperation with the states in securing uniformity in weights and measures laws and methods of inspection,” developed Section 10.3.

10.3. Aerosols and Similar Pressurized Containers. – The declaration of quantity on an aerosol package and on a similar pressurized package shall disclose the net quantity of the commodity (including propellant), in terms of weight, that will be expelled when the instructions for use as shown on the container are followed.

Several states, which are among the 32 that have adopted the Uniform Packaging and Labeling Regulation, indicated that pressurized cans were currently being marked by volume rather than by weight as required above. Industry representatives indicated that according to the FDA, they are permitted to mark this type of container by volume and that for competitive purposes they will continue to do so. The NCWM was asked to contact FDA and inform them that a declaration of volume on pressurized containers is not acceptable to the states since it cannot be verified.

A meeting was requested to express NIST/NCWM’s concern over the FDA position on quantity of contents declarations on aerosols, which is found in the Fair Packaging and Labeling Act (FPLA) Manual Guide FDA 7563.7. This Guide states that in the past, the FDA has not objected to the use of units of volume to declare the net contents of aerosol preparations that would be liquid if not combined with the propellant and a net weight statement in avoirdupois units for products that would be solids if not combined with a propellant. The FDA was asked to modify its position to provide that existing state regulations (concerning aerosol quantity of contents declarations) are not superseded by FDA Guidelines. FDA officials stated that the FDA would consider the request, but it did not appear at the time of the Interim Meetings that the FDA would make any statement to modify its position without following its administrative procedures and permitting interested parties to exhaust every element of due process.

One industry representative stated that there has been a good deal of concern that fluorocarbon propellants may in the long run cause the partial destruction of the ozone layer in the upper atmosphere surrounding the earth, and that the diminution of the ozone layer would have adverse effects on human health. Therefore, they have converted to new formulations which eliminate fluorocarbon propellants. As a result of this conversion to a non-fluorocarbon propellant system, which uses a propellant with a much lower density than that of the usual fluorocarbon propellants, continued use of a weight measure would be highly misleading to the consumer. Therefore, some spray labels have been changed so as to denote the contents in terms of fluid measure, rather than in terms of weight measure.

The industry representative stated that if manufacturers were to be required to use weight measure, consumers would be deceived into buying products, such as hair spray, with large amounts of fluorocarbon that vaporizes before it reaches the hair. Consumers prefer products with a large amount of base. Industry further indicated that they wanted to avoid a confrontation with the states over this issue and believe that the matter can readily be resolved without the need for litigation. Although the use of fluid measure on the principal panel will give consumers the most helpful information at the point of purchase, the industry would have no objection to putting the net weight on the back of the label.

The Committee wants to commend FDA for their interest in this matter and the manufacturers who seek to improve their product and its labeling information. The Committee is also encouraged to work with all interested parties to resolve this issue. However, the Committee does not believe that mere guidelines can preempt a Uniform Regulation developed under the technical authority of the federal agency delegated by Congress and adopted by the states through its representatives, no matter how broad the preemptive clause of an act might be. Additionally, the Committee cannot support open and notorious violations of state regulations where those violations occurred prior to bringing the issue before the Conference. Therefore, the Committee believes that NCWM should support a firm stand by the states that their regulations must be respected.

2.2.7. Aerosol Packaged Products.

(Liaison, 1979, p. 239)

See also Guideline 2.2.6.

Policy

The NCWM recommends all aerosol packages be labeled by net weight. FDA permits volume declarations. The NCWM has requested the FDA to change its regulations and revise its interpretation of these regulations.

Substance of Petition

The NCWM petitions the FDA to make the necessary changes to their regulations and interpretation of 21 CFR 101.105(g) as appearing in the FDA Fair Packaging and Labeling Manual Guide, 7563.7 pertaining to the quantity of contents declaration on aerosol packaged products. It is requested that the net quantity statement on aerosol packaged products or similar pressurized packages be made in terms of net weight only. The reasons for recommending such changes are as follows:

1. Net quantity labeling of aerosol packaged products in terms of net weight is a firmly established trade practice for such products.
2. Net quantity labeling of aerosol packaged products in terms of volume is difficult (if not impossible) to verify with consumer verification methods or by conventional package inspection methods. State or local enforcement action is discouraged by such labeling.
3. Since the labeling of aerosol packaged products by volume cannot be compared with the labeling of such products in terms of net weight, labeling in terms of volume and weight inhibits value comparisons and causes consumer confusion with respect to the quantity of product the consumer is buying and can be a form of deceptive labeling.

4. Uniformity between all state and federal regulations is highly desirable for both enforcement and fair competition in the marketplace. The Uniform Packaging and Labeling Regulation and the FTC and EPA Regulations require net quantity labeling of aerosol packaged products in terms of net weight.

2.2.8. Variety and Combination Packages.

(L&R, 1982, p. 149)

See also Guideline 2.2.1.

Interpretation

- (a) Seasonal gift packages are “variety packages” within the meaning of the Uniform Packaging and Labeling Regulation if they contain “reasonably similar commodities” (such as various fruits). They are “combination packages” if they contain “dissimilar commodities” (such as wine, fresh fruit, and jellies). Variety package labels must declare the total quantity in the package. Combination package labels must declare a quantity declaration for each portion of dissimilar commodities.
- (b) The example provided with Section 10.6., Variety Packages, of the Uniform Packaging and Labeling Regulation, shows a total quantity declaration and individual declaration for each type of commodity. The individual declaration is not required but is encouraged.

Background

The Committee reviewed Section 10.5 and Section 10.6 of the Model Packaging and Labeling Regulation in order to determine the need for further clarification. Several questions have arisen over the years with respect to:

- (1) What are the net contents labeling requirements for seasonal gift packages composed of varying types of commodities or goods all combined into one package?
- (2) Is the example provided in Section 10.6. entirely in keeping with the declaration requirements? (This section requires that total net contents be declared, but the example shows both total and individual net contents.)

The Committee believes that there is no need to modify these sections, but the discussions below may serve as guidance to enforcement officials and packagers on these sections.

Concerning labeling requirements for seasonal gift packages, it must first be determined what the individual units comprising each package are. The following examples are possibilities:

- (a) individual packages of sausage, individual packages of cheese;
- (b) several kinds of fruit of different weights; and
- (c) several kinds of fruit, bottle of wine, several packages of cheese.

Examples (a) and (c) above are combination packages and should be labeled with net quantities of each unit or type of unit. It is possible to combine fruit net weight (or count if appropriate) as one declaration, cheese net weight as a second declaration, etc.

Example (b) above is a variety package and must be labeled with the total net weight or count (as appropriate) of fruit in the package. It is also reasonable for packagers to include, for full consumer information, a declaration of the individual net contents of each type of package or item in the gift package although this latter declaration is not required (e.g., 1 lb bananas, 3 pears). This is also the key to the second question asked above concerning the example provided in Section 10.6.; that is, although a declaration of individual item net contents is not required, packagers are encouraged to provide additional information wherever useful to the consumer.

2.2.9. Textile Products.

(L&R, 1977, p. 215)

Interpretation

- (a) When a range of widths (e.g., 58/60) appears on the label of bolts or rolls for yard goods, enforcement action should be taken whenever the action width falls below the lesser of the two widths given as the range (in the example above, when the fabric width is less than 58 in).
- (b) Section 10.9.3. Textiles: Variations from Declared Dimensions of the Uniform Packaging and Labeling Regulation is not to be interpreted as providing tolerances. The average requirement must be met. The average quantity of contents of a lot, shipment, or delivery must equal or exceed the declared dimensions. Dimensions of individual packages of textiles may vary as much as Section 10.9.3. permits, but the average requirement must still be met.

Background

The State of California and the American Textile Manufacturers Institute asked the NCWM Laws and Regulations Committee and the National Institute of Standards and Technology to assist in the resolution of two textile-product issues. In the first issue California asks for help in correcting a short measure condition, apparently a nationwide problem, which has been found in the packaging and labeling of textile yard goods put up on bolts or rolls.

The problem is outlined as follows:

1. Approximate width measurements are being used by some manufacturers in their label declarations.

Example:

58/60 in (inch) width.

2. Label declarations are false and misleading in that actual amounts are less than the quantity represented on the label.
3. Section 10.9.3. of the Uniform Packaging and Labeling Regulation is extremely vague as to its intent and true meaning. Are the substantial variations (3 % and 6 %); (6 % and 12 %) permitted as product tolerances, or are they maximum unreasonable minus and plus errors to be allowed when sampling the product for quantity when using Handbook 67?

California favors the repeal or clarification of Section 10.9.3. and suggests amending Section 10.9.2.(k) to read:

The quantity statement for packages of textile yard goods packaged on the bolt or roll for either wholesale or retail shall state its net measure in terms of yards for the length and width of the item, or its net weight in terms of avoirdupois pounds or ounces, or in terms of their metric equivalent.

During the Interim Meetings, a representative of the American Textile Manufacturers Institute (ATMI) informed committee members that the proposal to identify the width of yard goods with a single measurement (as opposed to a range) would be given serious consideration by their members, after which a recommendation will be finalized and submitted to the Laws and Regulations Committee.

After the Interim Meetings, the National Home Sewing Association said that if a single width declaration is required, the following could result:

- (a) No change in manufacturing process would be effectuated; only the size declaration on bolts would be changed.

- (b) Short measure problems could be created because consumers would look for the fabric to be exactly the stated width. Because the manufacturing processes were not changed, the width is actually the same as it was with the range declaration.
- (c) Increased cost to manufacturers would result. One loom is used for many different fibers now; a single width declaration could create a need for many looms for each of the different fibers, thereby imposing “pass-along” costs to consumers.
- (d) Consumer deception would be fostered in that a single declaration implies actual measurement.

California officials state that roll or bolt fabric should be labeled accurately with a single declaration. Additionally, they believe that industry does have enough shrinkage data on fibers used in the manufacturing processes, and thus could provide accurate measurement declaration on finished fabrics or materials.

The Committee believes that accurate quantity information should be provided on consumer products; however, no labeling changes should be required until patterns and yard goods are marketed in metric units. At that time, all measures shall be singularly stated (eliminating dual numbers) and, until that time, any products where size declaration is a range and found to be less than the smaller of the range declaration shall be subject to enforcement action. For example, a product marked “58 to 60 in” and found to be less than 58 inches should be considered to be in violation of weights and measures laws and/or regulations.

Additionally, the Committee affirms that the intent of the Variations from Declared Dimensions permitted in Section 10.9.3. in no way eliminates the requirement that quantity declarations for textiles must, on the average, not be less than declared declarations.

2.2.10. Yarn.

(L&R, 1983, p. 153)

Interpretation

The appropriate net contents declaration for yarn is weight.

Background

A consumer has requested that the net quantity statement for yarn be changed from weight to length. The proposal is based on the consumers’ use of the product, darker colors often weigh more per unit of length. Therefore, they found that a lighter color yarn will “go farther” in craft applications than a darker yarn; consumers indicate that it is difficult to predict how much yarn of varying colors to purchase based on a weight declaration. The Committee is sympathetic to the request but must support existing labeling requirements for several reasons.

Yarn, by nature, is extremely stretchy; in order to label yarn by length, a specified tension would have to be applied in order to make any repeatable length measurement. Such a tension would have to be agreed upon by all the yarn manufacturers, and they would have to apply to compliance testing of product by weights and measures officials. Even if this tension “standard” were negotiated and decided upon, it would have little real meaning in use by needle crafters, knitters, and others. The tension applied to yarn in use varies from user to user and from application to application; therefore, the length also varies. Not only does dyeing yarn change the weight, dyeing also changes the length of yarn. For these reasons, industry representatives also support the requirements as they presently are written in the Uniform Packaging and Labeling Regulation.

The Committee recognizes the difficulty of working with this product and suggests that users of yarn consider buying an excess of the yarn over what is expected to be used in any application. The consumers should find out before purchase if, after finishing the product, they can return the unopened skeins to the retailers from whom the skeins were purchased.

2.2.11. Tint Base Paint.

(L&R, 1986, p. 146)

Section 11.23. of the Uniform Packaging and Labeling Regulation currently permits tint base paints (paints to which colorant must be added prior to sale) to be labeled in terms of the volume (a quart or gallon) that will be delivered to the purchaser after addition of the colorant only if three conditions are met:

1. “the system employed ensures that the purchaser always obtains a quart or a gallon”;
2. “a statement indicating that the tint base paint is not to be sold without the addition of colorant is presented on the principal display panel;” and
3. “the contents of the container, before the addition of colorant, is stated in fluid ounces elsewhere on the label.”

2.2.12. Reference Temperature for Refrigerated Products: When a Product is Required to be Maintained under Refrigeration.

(L&R, 1990, p. 86)

Background

Section 6.5.(b) was revised to clarify that the reference temperature of 4.4 °C (40 °F) applies only to products that must be refrigerated to maintain product quality, rather than to items, such as carbonated soft drinks, that are refrigerated for the purchaser’s convenience.

Guideline

The Committee also discussed how an inspector could decide whether a product under refrigeration is required to be maintained under refrigeration. The following guidelines are provided:

1. The traditional food items that normally require refrigeration and are found in refrigerated cases will not ordinarily have any statement about requiring refrigeration. These items include milk, orange juice, and similar products. They may be tested at any temperature at, above or below their reference temperature of 40 °F (4 °C) because such products are at their maximum density at their reference temperature, and the volume of such products will always increase at higher or lower temperatures. Thus any errors made by not measuring at the exact reference temperature will be in the favor of the packer.
2. Food items that normally require refrigeration, but which are processed so as not to require refrigeration prior to opening, will have “refrigerate after opening” or similar wording on the label. Such items as milk and orange juice can be found in this category as well as in the “refrigeration required” category. The two categories can be distinguished by the “refrigerate after opening” statement, which calls for testing at or above their reference temperature of 68 °F (20 °C).
3. Food items that are not expected to require refrigeration, but which may be refrigerated for the convenience of the consumer (such as carbonated beverages), are to be tested at temperatures of 68 °F (20 °C) or above even when found refrigerated for the convenience of the consumer.

2.2.13. Declaration of Identity: Consumer Package (UPLR) and 1.5.1. in Combination with Other Foods (UMSCR).

(L&R, 1990, p. 93)

Background

Many food products are made by the retail store and labeled with names that may or may not have standards of identity or standards of composition in federal regulation or policy (for example, chicken cordon bleu). Weights and

measures officials need to know which names have standards of identity that must be followed in formulating the product and, therefore, in providing the ingredient statement.

Food Standards

The U.S. Department of Agriculture's Food Safety and Inspection Service (USDA - FSIS) and the U.S. Department of Health and Human Services' FDA share the responsibility of assuring truthful and accurate information on product labels. USDA - FSIS has responsibility for the development and application of the labeling requirements applicable to meat and poultry products containing more than 3 % fresh meat or at least 2 % cooked poultry meat. FDA oversees the labeling of most other food products.

USDA Standards of Identity and Composition

USDA has statutory authority to establish standards of identity for meat and poultry products. A standard of identity prescribes a manner of preparation and the ingredients of a product that is labeled with a particular name. A food that bears the name of a standardized food that does not satisfy the requirements of the applicable standard is misbranded. Examples of standardized products include: "Ham," "Ham Water Added," "Hot Dogs," "Chicken and Noodles," and "Spaghetti Sauce with Meatballs."

Almost all standards enforced by FSIS are called "standards of composition." These standards identify the minimum amount of meat or poultry required in a product's recipe. For example, the standard of composition for "beef a la king" states that, if a product carries this name on its label, at least 20 % cooked beef must be used in the recipe.

But standards of composition do not prevent a manufacturer from increasing the meat or poultry content or adding other ingredients to increase a product's appeal. For instance, a processor has the option of using more than the required amount of beef in beef a la king and adding other ingredients to make the product unique. A listing of meat and poultry content and labeling requirement including terms that are further defined can be found in the USDA FSIS Food Standards and Labeling Policy book which is available at www.fsis.usda.gov/OPPDE/larc/Policies/Labeling_Policy_book_082005.pdf.

Label Approval

Food manufacturers **are responsible for** compliance with the FSIS labeling rules and adherence to the process maintained by FSIS for the evaluation and approval of meat and poultry product labels. This Guide provides the basic information necessary to devise a label for meat and poultry products and to understand the regulatory process administered by FSIS. A Guide to Federal Food Labeling Requirements for Meat and Poultry Products (2007) URL is located at www.fsis.usda.gov/PDF/Labeling_Requirements_Guide.pdf.

2.2.14. Typewriter and Computer Printer Ribbons and Tapes.

(L&R, 1991)

Interpretation

Typewriter and computer printer ribbons must be labeled by length. In addition, character yield information may be disclosed on the principal display panel.

Background

Packages of typewriter and computer printer ribbons and tapes have been found in the marketplace with no declaration of quantity of any kind. There is information on the package about the type of machine the ribbon or tape is designed to fit, but this is not a declaration of quantity. Purchasers have been misled as a result of the failure of some manufacturers to disclose the length; ribbons designated for a particular machine may be sold at a low price, but with substantially less length than ribbons ordinarily produced for the machine.

2.3.1. Instant Concentrated Products.

(L&R, 1977, p. 219)

Interpretation

No additional net contents information (other than weight) is required for instant coffee, tea, and cocoa.

Background

It was proposed that certain products, such as instant coffee, tea, and cocoa, should have a dual statement of weight including the number of cups (e.g., makes ten 6 oz cups).

The National Coffee Association of U.S.A., Inc., offered the following comments:

1. The number of servings of instant coffee will depend upon the size of the cup involved and the taste of the individual consumer.
2. The size of a cup will vary widely, ranging from a small “demitasse” cup to a large coffee mug.
3. The taste of the individual consumer defies definition because it will vary as widely as the number of individuals considered. Market research shows many like it “strong and black” and others prefer it “mild and thin.”
4. Any statement placed on a container of instant coffee that represents that the consumer will be able to obtain a specified number of servings would be arbitrary, confusing and, in a very sense, deceptive.
5. In view of the foregoing, any such requirements that the number of servings be listed on a container of instant coffee might expose the manufacturer to complaints from consumers that it was engaging in an unfair and deceptive practice.

Other issues that the Committee discussed included the authority to require precise directions (rather than, for example, 2 to 3 heaping teaspoons) and the issues of product variability and uniform enforcement.

2.3.2. Fresh Fruits and Vegetables.

(L&R, 1979, p. 176; 1980; 1982, p. 152; 2008)

Guideline

Recognizing the difficulty faced by consumers when more than one method of sale is employed in the same outlet for the same product, non-comparable methods of sale (e.g., weight and measure) for the same produce item in the same outlet should be minimized.

This guideline applies to all sales of fruits and vegetables. There are two tables, one for specific commodities and one for general commodity groups. Search the specific list first to find those commodities that either do not fit into any of the general groups or have unique methods of sale. If the item is not listed, find the general group in the second table. The item may be sold by any method of sale marked with an X.

(Amended 2008)

| Method of Retail Sale for Fresh Fruits and Vegetables Specific Commodity | | | | | |
|---|--------|-------|---------------------|------------------------------|--|
| Commodity | Weight | Count | Head or Bunch | Dry Measure (any size) | Dry Measure (1 dry qt or larger) |
| Artichokes | X | X | | | |
| Asparagus | X | | X | | |
| Avocados | | X | | | |
| Bananas | X | X | | | |
| Beans (green, yellow, etc.) | X | | | | X |
| Brussels Sprouts (loose) | X | | | | |
| Brussels Sprouts (on stalk) | | | X | | |
| Cherries | X | | | X | X |
| Coconuts | X | X | | | |
| Corn on the Cob | | X | | | X |
| Dates | X | | | | |
| Eggplant | X | X | | | |
| Figs | X | | | | |
| Grapes | X | | | | |
| Melons (cut in pieces) | X | | | | |
| Mushrooms (small) | X | | | X | X |
| Mushrooms (portobello, large) | X | X | | | |
| Okra | X | | | | |
| Peas | X | | | | X |
| Peppers (bell and other varieties) | X | X | | | X |
| Pineapples | X | X | | | |
| Rhubarb | X | | X | | |
| Tomatoes (except cherry/grape) | X | X | | | X |

| Method of Retail Sale for Fresh Fruits and Vegetables General Commodity Groups | | | | | |
|---|--------|-------|---------------------|------------------------------|---|
| Commodity | Weight | Count | Head or Bunch | Dry Measure (any size) | Dry Measure (1 dry qt or larger) |
| Berries and Cherry/Grape Tomatoes | X | | | X | |
| Citrus Fruits (oranges, grapefruits, lemons, etc.) | X | X | | | X |
| Edible Bulbs (onions [spring or green], garlic, leeks, etc.) | X | X | X | | X |
| Edible Tubers (Irish potatoes, sweet potatoes, ginger, horseradish, etc.) | X | | | | X |
| Flower Vegetables (broccoli, cauliflower, brussel sprouts, etc.) | X | | X | | |
| Gourd Vegetables (cucumbers, squash, melons, etc.) | X | X | | | X |
| Leaf Vegetables (lettuce, cabbage, celery, etc.) | X | | X | | |
| Leaf Vegetables (parsley, herbs, loose greens) | X | | X | X | |
| Pitted Fruits (peaches, plums, prunes, etc.) | X | X | | | X |
| Pome Fruits (apples, pears, mangoes, etc.) | X | X | | | X |
| Root Vegetables (turnips, carrots, radishes, etc.) | X | | X | | |

2.3.3. Cardboard Cartons.

(L&R, 1974, p. 223)

Guidelines and Interpretations

Cardboard cartons should be sold by their dimensions. Identification numbers used in the trade do not correspond to these dimensions and could tend to mislead the uninformed purchaser (although there is no actual unit such as inches associated with the identification numbers). Sales or catalogue literature will have to be investigated to determine whether there is sufficient information upon which to make a purchasing decision.

Background

Copies of letters received by the New York Bureau of Weights and Measures regarding cardboard containers were forwarded to the Committee. These letters highlight the confusion that exists when these containers are sold to new businessmen by an identity number which is often mistaken for the size of the box. For example, a 30 x 4 identification number refers to a box whose actual size is 27 x 3 inches. It was suggested that a new section be added to the Method of Sale of Commodities Regulation so that these containers can be sold on a basis that will provide more accurate information.

An important argument in support of adding a new section is that small businessmen just getting started need as much assistance as can be provided in order to survive and grow.

An argument opposing this change is that a table, similar to Table 1. of Section 2.9. (Softwood Lumber) of the Uniform Method of Sale Regulation, could be printed showing the relationship between identity and size; this would not solve the problem.

It is the consensus of the Committee that these containers should be sold by actual size. The Committee does not believe, however, that every trade practice must be controlled through the Uniform Laws and Regulations. This is

particularly true where the item does not directly concern the retail consumer. The Committee, therefore, recommends that the appropriate trade associations be contacted and asked to correct this practice on a voluntary basis.

2.3.4. Catalyst Beads.

(L&R, 1981, p. 100)

Guideline and Interpretation

The proper method of sale of catalyst beads used in automobile exhaust systems is by volume. It is appropriate for the quantity declaration to be supplemented by part number or other description of the specific converter for which the package of catalyst beads is intended.

Background

A communication from the General Motors Corporation AC Spark Plug Division was forwarded to the Committee which proposes discontinuing the labeling of their catalyst beads by weight. When the catalyst becomes contaminated by leaded gasoline or prolonged use, the catalytic converter in the exhaust system of recent GM cars and trucks (running on unleaded gasoline) must be emptied of its catalyst beads and be refilled by volume with replacement catalyst beads in order to meet emission standards. The beads are used by volume (to fill a catalytic converter), are hygroscopic, and vary in core material density. Therefore, packages of beads meeting a net weight label require an additional one-third pound (on the average) over the packages labeled by volume, cost about \$7.50 more per package, and the additional weight of beads will be discarded in actual use.

2.3.5. Incense.

(L&R, 1978, p. 151)

Interpretation

Incense labeled by count is fully informative and sufficient.

Background

The State of Oregon raised the issue of proper quantity declarations for the sale of incense. The question is what, if any, information other than count, such as weight or volume or length, is necessary for an adequate description on packages of incense. The Committee is of the opinion that a statement of count as defined in Section 6.4.1(c) of the Uniform Packaging and Labeling Regulation is fully informative and is sufficient in this case.

2.3.6. Sea Shells.

(L&R, 1976, p. 223)

Guideline

Sea shells shall be sold by count and weight for packages of 50 sea shells or less and by volume and weight for packages containing more than 50 sea shells.

2.3.7. Tire Tread Rubber Products.

(L&R, 1976, p. 233)

Guideline

Tire tread rubber products shall be sold by net weight. The polyethylene film protective backing shall be part of the product and included in the net weight. The core is part of the tare and must be deducted from the gross weight to determine the net weight.

2.3.8. Wiper Blades.

(L&R, 1979, p. 182)

Interpretation

There is a trade custom of labeling automobile wiper blades by the length of the metal backing or vertebra, not the length of the blade. This is an acceptable method of sale and net contents declaration.

Background

The Committee received a request from a manufacturer of automobile wiper blades that had a problem with one state concerning the measurement of length as labeled on their packages. The state felt that the proper designation should be the length of the blade itself; the manufacturer said that traditionally the industry measured the length of the metal backing or vertebra.

The Committee, after some discussion, determined that since there was no intent to mislead customers, the traditional measurement of the metal backing or vertebra was acceptable.

2.3.9. Fireplace Logs.

(L&R, 1975, p. 174)

Interpretation

Time of burning is not an appropriate quantity declaration for fireplace logs. (Section 2.4.3. of the Uniform Method of Sale of Commodities requires single logs to be sold by weight, or if packaged and less than 4 ft³, weight plus count.)

Background

The enforceability of quantity declarations using time as the basis of measurement for commodities, including packaged commodities, must be considered carefully if equity in the marketplace is to be achieved. The Committee wants to stress to those who have submitted time declaration questions that the enforceability factor should not override consumer protection and uniformity considerations. Based on the above criteria, the Committee recommends that the Conference take the position that time is not an appropriate quantity declaration for fireplace logs.

2.3.11. Packaged Foods or Cosmetics Sold from Vending Machines.

(L&R, 1982, p. 152)

Interpretation

Packaged foods and cosmetics sold from vending machines must be labeled the same as similar items not sold in vending machines, including identity, responsibility, net contents, and ingredient declaration, except that Section 3.3. of the Uniform Regulation for the Method of Sale of Commodities permits identity and net contents to be posted on the machine in lieu of appearing on the package.

Background

As part of its review of the Uniform Regulation for the Method of Sale of Commodities, the FDA recommended adding a statement to Section 3.3. that packaged foods and cosmetics sold in vending machines must in general be labeled in accordance with requirements for similar articles not sold in vending machines (e.g., ingredient declaration requirements). The Committee recommends that this information be made a guideline rather than incorporated as part of the uniform regulation.

2.3.12. Movie Films, Tapes, Cassettes.

(L&R, 1975, p. 174)

Guideline

Movie film may be sold by linear measure. Magnetic tapes and cassettes may be sold by either linear measure or playing time.

Background

The enforceability of quantity declarations using time as the basis of measurement for commodities, including packaged commodities, must be carefully considered to achieve equity in the marketplace. The Committee wants to stress to those who have submitted time declaration questions that the enforceability factor should not override consumer protection and uniformity considerations. The committee further recommends that the states follow FTC guidelines in requiring lineal measure for the sale of movie films and permit either linear measure or playing time for magnetic tapes and cassettes.

2.3.13. Vegetable Oil.

(L&R, 1983, p. 208)

Guideline and Interpretation

Packaged liquid vegetable oil must be labeled by liquid volume, although net weight may also be declared.

Background

Packages of liquid vegetable oil are being sold for restaurant and other small food business use labeled by weight. It has been brought to the attention of the Committee that containers of product labeled "5 gal" look identical in dimensions to those labeled "35 lb" but the density of the vegetable oil is such that the 35 lb cans contain only about 4½ gal. The Institute of Shortening and Edible Oils indicated that companies selling liquid vegetable oils often compete with those selling solid shortening, and that a net weight comparison is useful for these purposes. Recipes for food products in large sizes sometimes provide ingredient quantities by weight or volume.

It is the opinion of the members of the Committee that packaged liquid vegetable oil must be labeled by liquid volume although a net weight may be declared in addition to the net volume statement.

When a single manufacturer of vegetable oil packages the same oil in the same size container with two such widely different net quantity statements, this practice could easily be considered (a) misleading to the customer, and (b) nonfunctional slack fill. Weights and measures enforcement action should be taken.

2.3.15. Bulk Sales.

(L&R Committee, 1986, p. 140)

When packaged or wrapped items (such as individually wrapped candies) are sold from bulk displays by weight, the price must be based on the net weight, not the weight including the individual piece wrappings. This will require (1) subtracting the weight of the bag into which the customer puts the pieces plus (2) subtracting the weight of the piece wrappings (the latter is a percentage of the gross weight – that is, the tare increases as the customer selects more of the commodity).

Background

Retail food stores are merchandising prepackaged commodities such as candies, pet food, snack bars, and bouillon cubes from bulk displays. Some retailers sell these products by gross weight. Section 1.2. of the Uniform Weights and Measures Law reads in part: "The term 'weight' as used in connection with any commodity means net weight. . ."

A workshop was held on June 20, 1986, at the U.S. Department of Commerce, Washington, D.C., to explore the issues and alternatives involved in the sale of prepackaged goods from the bulk food sales areas of supermarkets. Representatives of the packaging, supermarket, and small grocery industries, scale and point-of-sale (POS) systems manufacturers, the U.S. Food and Drug Administration, weights and measures agencies, and the National Institute of Standards and Technology attended. No final recommendations came from this meeting; however, the participants expressed an interest in meeting again after a written report of the June 20, 1986, meeting was made available and before the Interim Meetings of the NCWM in January 1987. The following issues were discussed:

1. Prepackaged commodities in bulk displays are being sold on a gross weight basis.

Federal regulations covering packaged goods and every state Weights and Measures Law require any sale by weight to be “net weight” (not including the weight of the wrapping materials). In some areas of the nation, many items are being sold on a gross weight basis in the supermarkets, for example, fresh fruit and vegetables in poly bags in the produce area. Perhaps because of the light weight of these bags (that is, the minimum size of the scale division on the ordinary supermarket checkout scale is large with respect to the weight of the poly bags), low priority is given to correcting this sales practice, and a lack of uniformity in enforcement of the net weight requirements results. Weights and measures officials have found tare amounting to over 40 % of the gross weight in prepackaged items sold from bulk; the majority of cases seems to range from 3 % to 12 %. Officials see the need to “draw the line” in a sales practice that appears to have evolved from other practices that were not heavily monitored and corrected at their inception.

2. Retailers face technical and administrative problems in properly deducting tare from the gross weight.

Automatic deduction of tare is preferable for large-scale retailers because of its speed. No equipment (either stand-alone scale or POS) is available at the present time that can: (1) subtract a percentage of the gross weight to represent the tare weight; or (2) subtract a fixed tare for the bag and a percentage tare for the wrapper on the prepackaged item. [Editor’s Note: There is equipment now available that can deduct a tare that is a percentage of the gross weight.] Two POS system manufacturers said that new systems with percentage tare capability could be designed, but they could not definitely say whether retrofitting existing systems was possible. They said that the ability to retrofit declined with the age of the system. Supermarket representatives expressed concern that their in-store computer software would need modification above and beyond the retrofitting or software redesign that might be done by the POS manufacturers; their software is designed around current POS software.

Deduction of tare in the bulk food area using a scale other than the checkout scale can be done more easily than at checkout if a POS system is being used. A tare look-up table used in conjunction with the scale appears to be the only currently used method that meets the net weight requirements when packaged products are sold from bulk. (The procedure is to gross weigh the product, look up the tare, subtract it from the gross weight, and then determine a final net weight and total price.)

Each retailer will have to consider the cost of additional manpower (as the weighing and marking of the purchase in the bulk food area might require), new equipment (purchasing scales or POS systems with percentage tare capability), or retrofit of existing equipment as compared with the value of the market share contributed by the bulk marketing of prepacked commodities. However, two supermarket chain representatives said that they expected some growth in this type of sale (because of the customers’ perception of cleanliness of the product, for example).

3. Present methods of sale and advertising are often misleading.

Suggestions were made that advertising on a “wrapped weight” basis would properly inform the consumer. However, it was pointed out that a typical purchaser does not know what “wrapped weight” is (i.e., gross weight). Moreover, selling packaged goods on a gross weight basis is illegal; it thwarts value comparison with other products sold by net weight.

Bulk food sales advertising often includes claims of savings of, for example, 10 % to 20 % over a purchase of the same commodity in standard-pack form. These advertising claims can be exaggerated and misleading if the comparisons referenced are between standard-pack commodities sold net weight and products sold from bulk on a gross weight basis.

The possibility of advertising a net weight unit price, but actually weighing at the checkout on a gross weight basis (and charging at a lower gross weight unit price) was discussed. For example, a sign could be posted with the following:

“\$1.50 per pound, net weight. We are not able to weigh this packaged product on a net weight basis (that is, without the wrapper), and will therefore charge you \$1.40 per pound including the wrapper weight at the checkout.”

Everyone agreed that advertising claims and appropriate wording would have to be chosen carefully if this is to be viable. However, those weights and measures officials present were generally opposed to this alternative based on the difficulty of enforcement and lack of assurance that a consumer would really understand explanatory signage.

2.5.6. Guidelines for NCWM Resolution of Requests for Recognition of Moisture Loss in Other Packaged Products.

(Exec, 1988, p. 94)

The Task Force on Commodity Requirements limited its work to only a few product categories, using these categories as models for addressing moisture loss. The gray-area concept is the result of this work.

Recognizing several candidates for future work in moisture loss, the Task Force recommends that the following guidelines for moisture loss be followed as far as possible by any industry requesting consideration:

1. There should be reasonable uniformity in the moisture content of the product category. For example, since pet food has final moisture contents ranging from very moist to very dry, some sub categorization of pet food needs to be defined by industry before the NCWM study of the issue.
2. The predominant type of moisture loss (whether into the atmosphere or into the packaging materials) must be specified.
3. Different types of packaging might make it necessary to subcategorize the product. For example, pasta is packaged in cardboard, in polyethylene, or other packaging more impervious to moisture loss. The industry should define the domain of packaging materials to be considered.
4. “Real-world” data is needed on the product as found in the retail marketing chain – not just laboratory moisture-loss data.
5. The industry requesting consideration of moisture loss for its product should collect data on an industry-wide basis (rather than from only one or two companies).

Information concerning the relative fractions of imported and domestically produced product should be available, for example, in order to assess the feasibility of interacting with the manufacturer on specific problem lots.

6. Moisture loss may occur either:
 - during manufacturing; or
 - during distribution.

Data will be needed to show the relative proportion of moisture loss in these different locations since moisture loss is permitted only under good distribution practices. Geographical and seasonal variations may apply.

7. A description of the processing and packaging methods in use in the industry will be of great value, as will a description of the distribution system and time for manufacturing and distribution. A description of the existing net quantity control programs in place should be given, together with information on how compliance with Handbook 133 is obtained. A description of maintenance and inspection procedures for the scales should be provided, together with information on suitability of equipment and other measurements under Handbook 44.
8. A description of federal and local agency jurisdiction and test should be given, as well as any regulatory history with respect to moisture loss and short weight. Has weights and measures enforcement generated the request? What efforts have addressed the moisture loss issue prior to approaching the NCWM? Are the appropriate federal agencies aware of the industry's request to the NCWM?
9. The industry should propose the type of compliance system and/or moisture determination methodology to be used. The compliance scheme, if it contains industry data components, should be susceptible to verification (examples: USDA net weight tests for meat; exchange of samples with millers for flour) and should state what the companies will do to provide data to field inspection agencies in an ongoing fashion (as the gray-area approach requires). If in-plant testing is to be combined with field testing, who is to do such testing, and how is this to be accomplished? It should be possible to incorporate the proposed testing scheme into Handbook 133 to be used with Category A or B sampling plans.

When all the preliminary information recommended above has been collected, a field test of the proposed compliance scheme should be conducted by weights and measures enforcement officials to prove its viability.

See the plan diagrammed on the next page.

Plan For NCWM Resolution of Individual Requests For Recognition of Moisture Loss

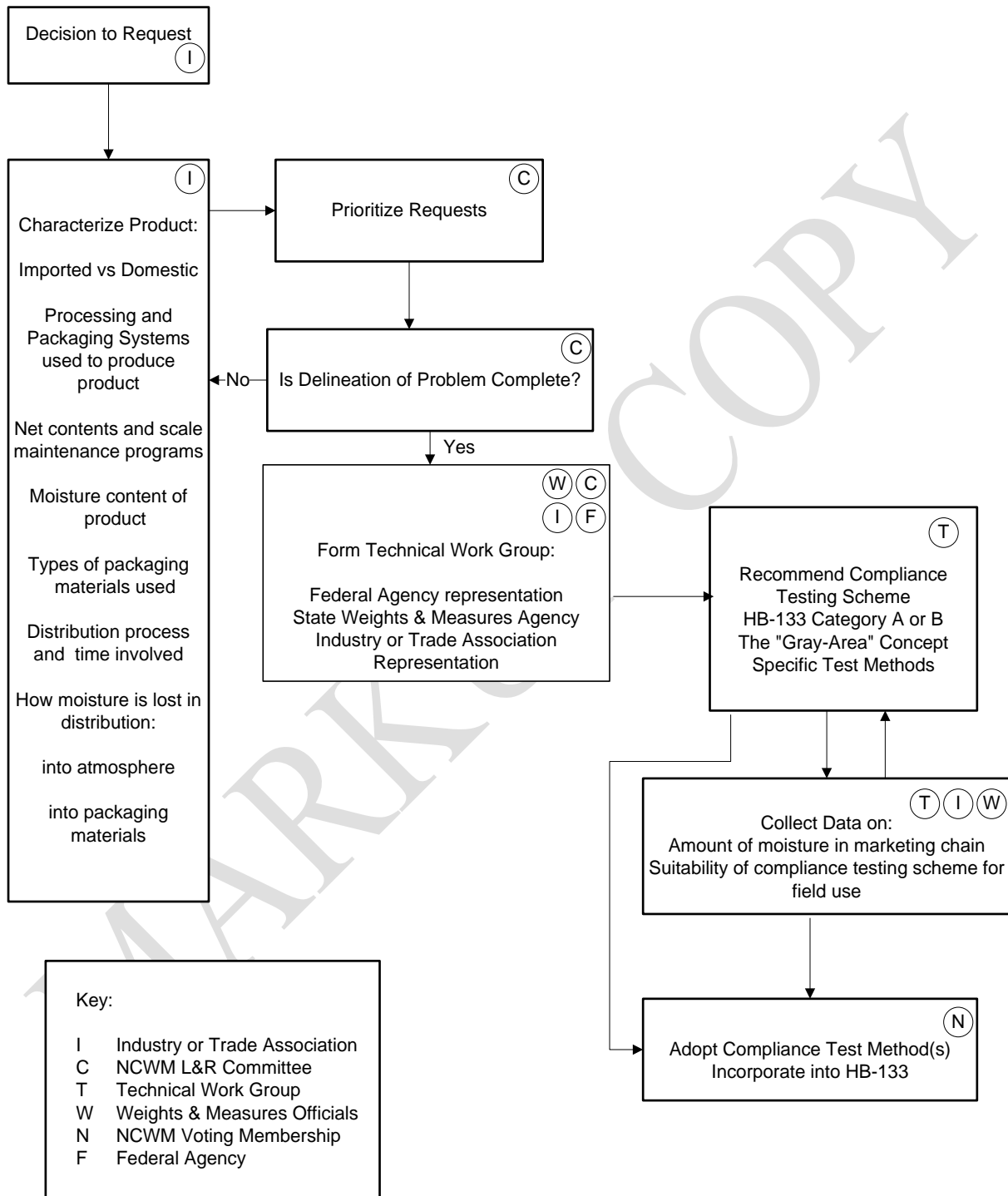

2.6.1. Retail Gas Sales and Metric Price Computations in General.

(S&T, 1980, p. 227)

Guideline

The National Institute of Standards and Technology published equivalent rounded values for metric equivalents of inch-pound units should be used. They are:

$$3.785411784 \text{ liters} = 1 \text{ gallon}$$
$$0.2641720524 \text{ gallon} = 1 \text{ liter}$$

A "Rule of Reason" should apply to the corrected value so that the value used is consistent with the quantity of the transaction. The converted value should never have fewer than four significant digits and should have at least the same number of significant digits as the number of significant digits in the quantity of product being converted. For example, if a 1000 gal delivery were to be converted to liters the value would be 3785 L; for 10 000 gal, 37 854 L; for 100 gal, 378.5 L.

In the case of expressing a unit price equivalent for consumer value comparisons in retail gasoline sales, the following formula should be used: (advertised, posted, or computing device unit price per liter) \times 3.785 = (equivalent unit price per gallon, rounded to the nearest $\frac{1}{10}$ cent.)

Examples:

$$26.9 \text{ cents per liter} \times 3.785 = \$1.018 \text{ per gallon}$$
$$26.8 \text{ cents per liter} \times 3.785 = \$1.014 \text{ per gallon}$$
$$26.7 \text{ cents per liter} \times 3.785 = \$1.011 \text{ per gallon}$$
$$26.5 \text{ cents per liter} \times 3.785 = \$1.003 \text{ per gallon}$$
$$26.4 \text{ cents per liter} \times 3.785 = \$0.999 \text{ per gallon}$$

This method is preferable to the alternative method of dividing the price per gallon by 3.785, which results in the same price per liter for three or more different prices per gallon when rounded to the $\frac{1}{10}$ cent.

2.6.2. Price Posting.

(L&R, 1981, p. 101)

Guideline

1. Street Signs.

- a. Until such time as the sale of gasoline and other Engine fuels is predominately by metric measurement (liter), price per gallon information should be made readily available to all prospective customers.
- b. All street, roadside, and similar advertising signs displaying product price should provide price per gallon information.
- c. Signs showing the equivalent price per liter may also be used, but their use is optional and should not employ numerals larger than the equivalent gallon price display.
- d. Signs should show complete dollar and cents numerals, and they should be clearly legible and of full size. An exception should be granted to street signs that were designed to display only three numerals (e.g., \$.899) and not four numerals as required for prices over \$1.00 per gallon (e.g., \$1.259). Until such signs can be replaced or modified, it would be acceptable:

- (1) to attach an appropriate sign extension with the decimal fraction of a cent representation in alignment with the posted price;

- (2) to include a smaller fraction of a cent representation with the last numeral of the posted price; or
 - (3) to add the whole number “one” before the cents values.
- e. The changeover to advertising prices by the liter as a single mode of pricing should be established when 75 % of all retail outlets in a jurisdiction have converted their dispensers to metric measurement.

2. Posting of Prices at the Dispenser.

Each retail outlet should use exclusively only one measurement method of sale (gallon or liter). A change from one method to another should be carried out for all devices dispensing motor fuels in the retail outlet.

In the case of liter sales, suitable posting of per gallon and per liter prices at the device, service island, premises of the retail outlet, or any other locations must be in accordance with state and local laws, regulations, and ordinances, and in a manner that facilitates consumer comparisons between the per gallon price and the per liter price. Additional requirements may be necessary to avoid uncertainty as to nomenclature, location, and size of information on signs.

It is recommended that:

- a. Current and accurate price comparisons between gallon and liter values be posted at the dispenser within easy view of the customer and visible from either side of the island.
- b. The sign should show equivalent quantity and price information.

Examples:

27.1¢ per liter = \$1.026 per gallon

3.785 liters = 1 gallon

- c. Letters and numerals should be at least $\frac{3}{4}$ in (19 mm) in height and $\frac{1}{8}$ in (3 mm) in width of stroke.

3. Quantity and Price Display on Dispensers

It is required that dispensers be designed to clearly show all required quantity and price information on the face(s) of a motor fuel dispenser in accordance with Handbook 44.

4. Dispenser Modification Kits

As an interim alternative to “half pricing,” a number of computer modification kits have been installed to modify existing retail motor fuel dispensers that were not designed to compute and indicate prices over 99.9¢ per gallon.

Some of the modification kits that have been referred to state weights and measures officials for approval have been rejected as failing to conform to Handbook 44 requirements. It is recommended that all modification kits and future modifications of dispensers be so designed and made as to be in full compliance with all applicable requirements of Handbook 44.

2.6.3. Octane Posting Regulations.

(Liaison, 1979, p. 240)

Guideline

Weights and Measures officials should report to the FTC any instances of failure to post octane ratings by service stations. These would most likely occur during routine inspections of service station gasoline dispensers. Reports should be made to the appropriate FTC regional offices as listed below.

Background

As of June 1, 1979, the FTC requires the determination of octane ratings by refiners, the certification of octane ratings by refiners and distributors, and the posting of octane ratings by retailers on all gasoline pumps. The requirements are set forth in Public Law 95 297, the Petroleum Marketing Practices Act (PMPA), passed in June 1978 and the FTC's Octane Rule, 16.C.F.R. Part 306. Although the octane posting rule has no effect on most FTC programs administered by state weights and measures officials with respect to checking gasoline dispensing devices for accuracy, the Liaison Committee feels that the Conference should be generally informed about the law and the FTC rule, if only to be prepared to answer inquiries about it or for some possible future enforcement demands. Keeping apprised of developments associated with the rule may be advisable. In addition, it will affect states which have octane certification and posting programs.

Regional Offices, Addresses, and Telephone Numbers:

| | | |
|--|---|--|
| <p>Northeast Region (CT, ME, MA, NH, NJ, NY, PR, RI, VT, and U.S. Virgin Islands)</p> <p>Federal Trade Commission One Bowling Green New York, NY 10004 (877) 382-4357</p> | <p>East Central Region (DE, DC, MD, MI, OH, PA, VA, and WV)</p> <p>Federal Trade Commission 1111 Superior Avenue Suite 200 Cleveland, OH 44114-2507 (877) 382-4357</p> | <p>Southeast Region (AL, FL, GA, MS, NC, SC, and TN)</p> <p>Federal Trade Commission Suite 1500 225 Peachtree Street, NE Atlanta, GA 30303 (877) 382-4357</p> |
| <p>Midwest Region (IL, IN, IA, KS, KY, NE, ND, MN, MO, SD, and WI)</p> <p>Federal Trade Commission 55 West Monroe Street Suite 1825 Chicago, IL 60603 (877) 382-4357</p> | <p>Northwest Region (AK, ID, MT, OR, WA, WY)</p> <p>Federal Trade Commission 915 Second Avenue, Room 2896 Seattle, WA 98174 (877) 382-4357</p> | <p>Southwest Region (AR, LA, NM, OK, and TX)</p> <p>Federal Trade Commission 1999 Bryan Street Suite 2150 Dallas, TX 75201-6808 (877) 382-4357</p> |
| <p>Western Region (AZ, Northern CA, Southern CA, CO, HI, NV, and UT)</p> <p>Federal Trade Commission 901 Market Street Suite 570 San Francisco, CA 94103 (877) 382-4357</p> | <p>Western Region (AZ, Northern CA, Southern CA, CO, HI, NV, and UT)</p> <p>Federal Trade Commission 10877 Wilshire Boulevard Suite 700 Los Angeles, CA 90024 (877) 382-4357</p> | |

The preemption section of PMPA (204) reads as follows:

Section 204. To the extent that any provision of this title applies to any act or omission, no state or any political subdivision thereof may adopt, enforce, or continue in effect any provision of any law or regulation (including any remedy or penalty applicable to any violation thereof) with respect to such act or omission, unless such provision of such law or regulation is the same as the applicable provision of this title.

Section 204 prohibits states and other political subdivisions from enforcing requirements that are not the same as the applicable provisions of this law. Jurisdictions having octane requirements should carefully review with their legal advisors the effect of this law.

The FTC's Octane rule was published in final form on March 30, 1979, in the Federal Register (Vol. 44, No. 63, Part V, pp. 19160-19172). The rule became effective June 1, 1979.

The law requires that refiners determine octane ratings of their products, and certify them to their distributors. The distributors must pass along the certification to the retailer, unless he blends the gas, in which case he may have to certify his blend.

A similar procedure relating to the posting of octane ratings is set forth for the retailer. The FTC is responsible for enforcement with respect to the accuracy of the certified ratings. The FTC is also empowered to check records, which must be retained for one year by each link in the distribution chain.

The FTC is in need of help from the state and local jurisdictions in the area of surveillance and testing. Such assistance could occur at a number of levels. Notice of octane mislabeling and failure to post octane ratings is requested.

Other levels of assistance would concern jurisdictions that have octane testing programs and would be interested in cooperating with FTC in testing or in reporting discrepancies in octane rating.

For more information contact the Federal Trade Commission at 600 Pennsylvania Avenue, NW, Washington, D.C. 20580, phone (202) 326-2222.

2.6.4. Multi-Tier Pricing: Motor Fuel Deliveries (Computing Pumps or Dispensers).

(L&R, 1982, p. 150; L&R, 1985, p. 100) (L&R, 1988, p. 162)

Policy

Charging different prices for the same product depending upon the manner of payment, other purchases, amount of service, etc., is a management decision of the merchandiser. Those merchants who elect to offer multiple prices for motor fuel must comply with the state and local weights and measure laws and regulations, including Handbook 44. They must also make marketing decisions that comply with state truth in lending, cash discount, price advertising, and usury laws. All such laws are intended to prohibit deceptive, misleading, or misrepresentative information being given to the consumer. The following guidelines are intended to apply to price advertising or posting at the street side or highway as well as at the pump or dispenser, and to the price computed at the device. These guidelines are applicable to other discount or combination offers (such as combination purchases of car wash and gas, for example).

1. If a price is posted or advertised, it must be available to all qualified customers. If any condition or qualification is required to obtain the posted price, that condition must also be posted clearly and understandably, in conjunction with the price wherever it is posted.
2. The lowest price may be posted or advertised by itself as long as any restrictions for receiving that price (for example, "cash only") are also clearly posted or advertised in conjunction with the price and as long as other state requirements do not prohibit it. For example, certain states require that all prices available from a given retail location must be posted on street side signs if any prices are posted.

3. If the merchandiser elects to establish separate devices or islands for sale of the same product at different prices, the devices or islands shall be clearly identified as “cash,” “credit,” “self-serve,” or other appropriate wording to avoid customer confusion.
4. The use of a single-price-computing dispenser for sale of motor fuel at multiple unit prices is inappropriate, facilitates fraud, and should be eliminated. The NCWM should adopt a plan and timetable for changeover to devices that can compute and display final money values for multiple prices.

2.6.5. Cereal Grains and Oil Seeds.

(L&R, 1981, p. 95; L&R, 1996, p. 135)

Interpretation

The addition of water to grain for the purpose of adding weight prior to selling grain by weight is an illegal practice under federal laws.

NOTE: Effective February 11, 1995, the Federal Grain Inspection Service adopted a regulation in 7 CFR Part 800.61 prohibiting the application of water to grain except for milling, malting, or similar processing operations. See Volume 59, No. 198 for Friday, October 14, 1994, or page 52 071, for additional information.

Background

A letter from the Oklahoma Grain and Feed Association was forwarded to the Committee asking whether the addition of water to grain is legal. The request was prompted by an article reporting on methods of adding water to grain to bring the moisture content up to market standards. For example, when soybeans are sold at 8 % moisture content, there is less weight sold (and less revenue for the soybeans to the seller) than if water were added to the same soybeans to bring them to 10 % moisture content.

However, the Committee is greatly concerned about the ramifications of such practices. Many grain experts do not believe that over-dried grain should be valued as highly as grain at moisture contents close to market standards. Overly dry grain is more susceptible to breakage, for example.

Water added after harvest will not be taken up chemically the way that naturally moist grain binds water. Errors in adding water or the particular biochemical nature of the grain after addition of water can lead to spoiled grain. Studies on the long term keeping qualities of grain with water added have not been carried out. The calibration of moisture meters is based on naturally moist grain, and there is a known difference between the electrical properties of naturally moist grain and grain with moisture added.

Of a more basic nature, however, the Committee recognizes the fact that a grain buyer purchases grain expecting such grain to be naturally moist or dried, not to be with water added. The seller who adds water to grain solely to add weight, therefore, misrepresents his product.

Both the FDA and USDA have sent letters to the Committee indicating that the addition of water to grain solely for the purpose of adding weight is an illegal practice. Because existing federal laws already prohibit this practice, the Committee recommends no further action on the part of the Conference at this time.

2.6.6. Basic Engine Fuels, Petroleum Products, and Lubricants Laboratory.

(L&R, 1994, p. 129-135; L&R, 2006, p. L&R-8) (Developed by the Petroleum Subcommittee.)

The petroleum fuels and lubricants laboratory is an integral element of an inspection program and is generally developed to satisfy the testing requirements as described in the laws and rules of the regulating agency. Guidelines have been developed to assist states in evaluating their options of employing a private lab or building or expanding their own lab. This information is available at www.nist.gov/pml/wmd/index.cfm.

2.6.7. Product Conformance Statements.

(L&R, 1992, p. 148)

Interpretation

References to a product's conformance with product standards (for example, "manufactured to standard EN235" or similar product conformance statements) on labels for wallcovering or other products, are not considered qualifying terms and do not violate Section 6.12.1., Supplementary Quantity Declarations of the Uniform Packaging and Labeling Regulation, provided the requirements of Section 8.1.4. Free Area is met.

Background

The Wallcovering Manufacturers Association (WMA) requested the Conference's position on the use of conformance statements on the labels of wallcovering and border material. This issue relates to wallcovering products that originate from manufacturers in Europe where a declaration of conformance to a specific government standard is required on consumer packages. Thousands of product "standards" or "Euronorms" are being established for the European Community. Conformance declarations are required to provide consumers and customs officials with information on the product. The issue relates to the use of such statements as "manufactured to standard EN235" on labels of wallcovering that are imported from Europe. The WMA requested the Committee's opinion on the use of this type of statement if a package is labeled in conformance with sections Section 6.12.1. Supplementary Quantity Declarations and Section 8.1.4. Free Area. One question is whether the display of the conformance statement would be permitted provided that it did not include an unacceptable quantity declaration. Another question concerns the need to comply with the requirement for adequate free area around the quantity declaration when the conformance declaration is placed on the label. It was the Committee's opinion that conformance statements on package labels would not violate any provisions of the PLR if the requirements of Sections 6.12.1. and 8.1.4. are met.

The Committee recommended this interpretation for inclusion in Handbook 130 because it is likely that this type of notice will become common as more and more free market trading areas are opened to expand international trade. This interpretation does not indicate acceptance or endorsement of any requirements contained in product conformance statements.

2.6.8. Commodities Under FTC Jurisdiction under the Fair Packaging and Labeling Act and Exclusions.

(L&R, 1993, p. 279; L&R, 1994, p. 294)

The following lists indicate the commodities and commodity groups that are and are not within the scope of the Fair Packaging and Labeling Act administered by the FTC. The following codes appear with each excluded commodity and designate the reason that the particular commodity has been excluded.

BATF – designates commodities subject to laws administered by the Bureau of Alcohol, Tobacco, and Firearms.

CI (Commission Interpretation) – designates those categories that have been excluded by the Commission in the light of legislative history of the definition of "consumer commodity." By applying this definition to individual commodities, the Commission has more narrowly applied the latter term and set forth a list of items that do not meet the criteria of consumer commodities. On occasion the Commission is requested in both a formal and informal manner to consider individual products and to determine their status relative to the definition of "consumer commodity" as it is used in the Act.

EPA – designates commodities subject to the Federal Environmental Pest Control Act of 1972 administered by the Environmental Protection Agency.

FDA – designates those commodities which are subject to regulation by the FDA either under the portion of the FPLA administered by that agency or the Federal Food, Drug, and Cosmetic Act (Section 10(a)(3) and Section 7 of the FPLA). Following the code FDA will be a letter further designating the commodity as either a food (F), drug (D), cosmetic (C), or device (DV).

USDA – designates those commodities excluded from jurisdiction by Section 10(a) of the FPLA and represents a commodity within one of the following categories: meat or meat products, poultry or poultry products, or tobacco or tobacco products.

It may be of some help in ascertaining whether a particular product is or is not included within the FPLA definition of “consumer commodity” and thus subject to FTC jurisdiction under that Act, to refer to the following definition:

“. . . Any article, product, or commodity of any kind or class which is customarily produced or distributed for sale through retail sales agencies or instrumentalities for consumption by individuals, or use by individuals for purposes of personal care or in the performance of services ordinarily rendered within the household, and which is usually consumed or expended in the course of such use.”

By applying these criteria to the particular product in question and then reviewing the list of excluded commodities, the observer will be able, in most instances, to determine the status of the item. In the event, however, that the observer is unable to ascertain whether a particular commodity is covered or excluded from FTC jurisdiction, contact FTC for an opinion.

| Commodities Included Under FTC Jurisdiction | |
|--|--|
| Soaps and Detergents | Powder, flakes, chips, etc. Liquid Paste, cake, or tablet |
| Cleaning Compounds | Liquid Powder Paste or cake Solvent and cleaning fluids for home use |
| Laundry Supplies | Conditioners and softeners, ironing aids, distilled water Sizings and starches Bluings and bleaches Pre-soaks, enzymes, etc. |
| Cleaning Devices | Sponges and chamois Steel wool, scouring and soap pads |
| Food Wraps | Plastic and cellophane Wax paper and paper Foil (aluminum wrap) |
| Paper Products | Toweling Napkins, table cloths, and place mats Facial tissues Bathroom tissues Disposable diapers Crepe paper Other (e.g., shelf paper, wrapping paper, eye glass tissues) |

| Commodities Included Under FTC Jurisdiction | |
|--|--|
| Waxes and Polishes | Powder Liquid Paste and cake Other (e.g., polish impregnated cloths, scratch removers) |
| Household Supplies | Matches Candles Toothpicks Cordage (string, twine, rope, clothes line, etc.) Drinking straws Lighter and propane torch fuel, flints, pipe cleaners, etc. Lubricants |
| Household Supplies (continued) | Picnic supplies Sand paper and emory paper Charcoal briquets, chips, logs, etc. Dyes and tints Camera film, photo supplies and chemicals Protective foil cooking utensils Aluminum foil cooking utensils Christmas decorations Solder LPG for other than home heating or cooking Waxes for home use Light bulbs Dry cell batteries Pressure sensitive tapes, excluding gift tapes |
| Containers | Paper (plain, waxed, or plastic coated) Foil Plastic or Styrofoam |
| Air Fresheners and Deodorizers | Potpourri |
| Adhesives and Sealants | |
| Cordage | |

| Commodities Excluded from FTC Jurisdiction | | |
|---|---|-------------------------|
| Term | Description | FTC Jurisdiction |
| Adhesive Tape | | FDA-D |
| Alcoholic Beverages | | BATF |
| Aluminum Clothesline | Plastic clothesline with a steel core | CI |
| Antifreeze | | CI |
| Artificial Flowers and Parts | | CI |
| Automotive Accessories | Floor mats, seat covers, spare parts, etc. | CI |
| Automotive Chemical Products | Auto polish, wax, and finish conditioner, rubbing compound, tire paint, chrome polish, gasoline additives, etc. | CI |
| Bath Oil and Bubble Bath | | FDA-C |
| Bicycle Tires and Tubes | | CI |
| Books | | CI |
| Bottled Gas | Cooking or heating | CI |
| Brushes | Bristle, nylon, etc., including hair-brushes, toothbrushes, hand and nail brushes, paint brushes, etc. | CI |
| Brooms and Mops | Glass, floor, and dish mops, etc. | CI |
| “Bug Proof” Shelf Paper | | EPA |
| Candle Holders | Without candles | CI |
| Cameras | | CI |
| Chinaware | | CI |
| Christmas Light Sets | Replacement or other bulbs sold separately are not excluded | CI |
| Cigarette Lighters | | CI |
| Clothespins | | CI |
| Clothing and Wearing Apparel | Socks, gloves, shoelaces, underwear, etc. | CI |
| Compacts and Mirrors | | CI |
| Cosmetics | Defined by Section 201(i) of the Food, Drug, and Cosmetic Act as “(1) articles intended to be rubbed, poured, sprinkled, or sprayed on, introduced into, or otherwise applied to the human body or any part thereof for cleansing, beautifying, promoting attractiveness, or altering the appearance, and (2) articles intended for use as a component of any such articles; except that such term shall not include soap.” | FDA-C |
| Cotton Puffs | Sterilized | FDA-D |
| Crystalware | | CI |
| Detergent Bar with Any Drug or Cosmetic Claim | If the observer experiences difficulty in ascertaining whether or not a given product is a soap or a detergent, contact the manufacturer or FDA. | FDA-D or C |
| Decorative Magnets | | CI |
| Devices | Defined by Section 201(h) of the Food, Drug, and Cosmetic Act as | FDA-DV |

| Commodities Excluded from FTC Jurisdiction | | |
|---|--|-------------------------|
| Term | Description | FTC Jurisdiction |
| | “instruments, apparatus, and contrivances, including their components, parts, and accessories, intended (1) for use in the diagnosis, cure, mitigation, treatment, or prevention of disease in man or other animals; or (2) to affect the structure or any function of the body of man or other animals.” This category includes trusses, syringes, arch supports, etc. | |
| Diaries and Calendars | | CI |
| Disinfectants | | EPA |
| Drugs | Defined by Section 201(g) (1) of the Food, Drug, and Cosmetic Act as “(a) articles recognized in the official United States Pharmacopeia, official Homeopathic Pharmacopeia, or official National Formulary, or any supplement to any of them; and (b) articles intended for use in the diagnosis, cure, mitigation, treatment, or prevention of disease in man or other animals; and (c) articles (other than food) intended to affect the structure or any function of the body of man or other animals; and (d) articles intended for use as a component of any articles specified in clause (a), (b) or (c); but does not include devices or their components, parts, or accessories.” | FDA-D |
| Durable Articles or Commodities | | CI |
| EPA Covered Products | Products subject to regulation under the Federal Environmental Pesticide Control Act that is administered by the Environmental Protection Agency. | EPA |
| Fingernail Files | | CI |
| Flowers, Flower Seeds, Fertilizer, and Fertilizer Materials, Plants or Shrubs, Garden and Lawn Supplies | | CI |
| Food | Defined by Section 201(f) of the Food, Drug, and Cosmetic Act as “(1) articles used for food and drink for man or other animals, (2) chewing gum, and (3) articles used for components of any such article.” | FDA-F |
| Fountain Pens, Mechanical Pencils, and Kindred Products | Ball point pens, lead pencils, and lead refills, etc. | CI |
| Garden Tools | Hoses, trowels, grass clippers, etc. | CI |
| Germ Killing or Germ Proofing Products | | EPA |
| Gift Tape and Ties | Ribbon, tape, etc. | CI |
| Gift Wrapping Material | Decorative wrapping foil, paper, cellophane, etc. | CI |
| Glasses and Glassware | Disposable plastic glasses are not excluded | CI |
| Gloves (of Any Type) | | CI |
| Greeting Cards | | CI |
| Hair Combs, Nets, and | | FDA-DV |

| Commodities Excluded from FTC Jurisdiction | | |
|--|--|-------------------------|
| Term | Description | FTC Jurisdiction |
| Pins | | |
| Hand Tools | | CI |
| Handicraft and Sewing Thread | Yarn, etc. | CI |
| Hardware | Extension cords, thumb-tacks, hose clamps, nails, screws, picture hangers, etc. | CI |
| Household Appliances, Equipment, or Furnishings, Including Feather and Down-Filled Products, Synthetic-Filled Bed Pillows, Mattress Pads and Patchwork Quilts, Comforters, and Decorative Curtains | | CI |
| Ink | | CI |
| Insecticides | Insect repellents in any form, mothballs, etc. | EPA |
| Ironing Board Covers | | CI |
| Jewelry | | CI |
| Lambs Wool Dusters | | CI |
| Luggage | | CI |
| Magnetic Recording Tape | Reels, cassettes, and cartridges. | CI |
| Meat and Meat Products | | USDA |
| Metal Pails | | CI |
| Motor Oil | Including additives. Household multi-purpose oil is not excluded. | CI |
| Mouse and Rat Traps | | CI |
| Mouthwash | | FDA-D |
| Musical Instruments | | CI |
| Paints and Kindred Products | Wallpaper, turpentine, putty, paint removers, caulking and glazing compounds, wood fillers, etc. Note, however, that bathroom caulking materials, patching plaster, spackling compound, and plastic wood are not excluded. In the event of uncertainty, contact FTC. | CI |
| Paintings and Wall Plaques | | CI |
| Pet Care Supplies | | CI |
| Pewterware | | CI |
| Photo Albums | | CI |
| Pictures | | CI |
| Plastic Buckets and | | CI |

| Commodities Excluded from FTC Jurisdiction | | |
|---|--|-------------------------|
| Term | Description | FTC Jurisdiction |
| Garbage Cans | | |
| Plastic Tablecloths, Plastic Place Mats | | CI |
| Plastic Shelf Lining | | CI |
| Pre-Moistened Towelettes | | FDA-C |
| Polishing Cloths | Polishing cloths that are impregnated with polish or chemicals (silicone, etc.) are not excluded. | CI |
| Poultry and Poultry Products | | USDA |
| Rubber Gloves | | CI |
| Rubbing Alcohol | | FDA-D |
| Safety Flares | | CI |
| Safety Pins | | CI |
| Sanitary Napkins | | FDA-D or C |
| School Supplies | Rulers, crayons, paper, pencils, etc. | CI |
| Self-Stick Protective Felt Tabs | | CI |
| Seeds of All Kinds | | USDA |
| Sewing Accessories | Needles of any type, thimbles, kindred articles, etc. | CI |
| Shampoo | | FDA-C or D |
| Shoelaces | | CI |
| Small Arms Ammunition | | CI |
| Silverware, Stainless Steelware, and Pewterware | | CI |
| Smoking Pipes | | CI |
| Soap Bars with a Drug Claim | Including any claim for removing facial blemishes, etc. Refer to Detergent Bars for further discussion in this area. | FDA-D |
| Soap Dishes | | CI |
| Souvenirs | | CI |
| Sporting Goods | | CI |
| Stationery and Writing Supplies | Looseleaf binders, paper tablets, etc. | CI |
| Textiles and Items of Wearing Apparel | Cloth laundry bags, towels, cheese cloth, shoe shine cloths, etc. | CI |
| Tobacco and Tobacco Products | Pipes, cigarettes, etc. | BATF - USDA |

| Commodities Excluded from FTC Jurisdiction | | |
|---|--------------------|-------------------------|
| Term | Description | FTC Jurisdiction |
| Toothpaste | | FDA-D |
| Toys | | CI |
| Typewriter Ribbon | | CI |
| Wire of Any Type | | CI |
| Woodenware | | CI |

2.6.9. Size Descriptors for Raw, Shell-On Shrimp Products.

(L&R, 1995, p. 97)

Guideline

If size descriptor terms for shrimp (e.g., small, medium, large, or colossal) are used on packages, advertisements, or on signs when offering shrimp for sale from bulk, a statement of count-per-kilogram, if sold by kilogram, or count-per-pound, if sold by pound, should be included adjacent to the size descriptor (e.g., medium-large, 31 to 40 shrimp per pound).

2.6.10. Model Guidelines for the Administrative Review Process.

Purpose

These guidelines are provided to assist weights and measures programs in establishing an administrative review process. They are not intended to be the only process an agency may use nor are they intended to supersede any agency's existing process. Before implementing ANY process, it should be approved by legal counsel.

These guidelines ensure that persons affected by "inspection findings" (e.g., price misrepresentations or shortweight packages), or who are deprived of the use of their property (devices or packages placed under "stop" or "off-sale" order), are provided a timely-independent review of the action. The process enables affected persons to provide evidence which could be relevant in determining whether the enforcement action was proper. The purpose of the process is to ensure that a person's ability to conduct business is not hindered by improper enforcement actions. This process is independent of any other action (e.g., administrative penalties, prosecutions, etc.) that may be taken by the enforcement agency.

Background

In the course of their work, weights and measures officials take enforcement actions that may prohibit the use of devices or the sale of packaged goods (e.g., "stop-sale" or "off-sale" orders for packages and "stop-use" or "condemnation" tags issued on devices). Improper actions (e.g., not following prescribed test procedures, enforcing labeling requirements on exempted packages, or incorrectly citing someone for a "violation") place the official and the jurisdiction in the position of being liable for the action if it is found that the action was "illegal." In some cases, weights and measures jurisdictions could be ordered to pay monetary damages to compensate the affected party for the improper action.

This process is one way to provide affected persons an opportunity to present evidence which may be relevant in determining whether the order or finding has been properly made to an independent party. The procedure enables business operators to obtain an independent review of orders or findings so that actions affecting their business can be evaluated administratively instead of through litigation. This ensures timely review, which is essential because of the impact that such actions may have on the ability of a business to operate and in cases where perishable products may be lost.

Review Provisions

Parties affected by enforcement actions must be given the opportunity to appeal enforcement actions.

Inspectors are the primary contacts with regulated firms and thus are in the best position to ensure that the enforcement actions they take are “proper.” “Proper” means that inspections are conducted (1) within the scope of the authority granted by law, (2) according to recognized investigative or testing procedures and standards, and (3) that enforcement actions are lawful. The “burden” for proving that actions are “proper” falls on the weights and measures program, not on regulated firms.

Weights and measures officials are law enforcement officers. Therefore, they have the responsibility to exercise their authority within the “due process” provisions of the U.S. Constitution. As weights and measure programs carry-out their enforcement responsibilities in the future, more and more challenges to their actions and authority will occur. It is in the best interest of any program to establish strict operational procedures and standards of conduct to prevent the occurrence of improper actions which may place the jurisdiction in an untenable position in a court challenge of an enforcement action. The foundation for ensuring “proper” actions is training, clear and concise requirements, and adoption of, and adherence to uniform test procedures and legal procedures.

Prior to taking enforcement actions the inspector should recheck test results and determine that the information on which the action will be taken is accurate.

Inspections shall be conducted with the understanding that the findings will be clearly and plainly documented and reviewed with the store’s representative.

During the review of the findings, the firm’s representative may provide information which must be used by the inspector to resolve the problems and concerns before enforcement actions are taken. In some cases, the provided information may not persuade the inspector to forego the action. In some cases, the inspector and business representative may not understand the circumstances surrounding the violations, or there may be a conflict between the parties that they cannot resolve. In other cases, the owner or manufacturer may not learn that an enforcement action has occurred until long after the inspector leaves the establishment.

Steps:

1. Provide a framework that will help in resolving most of these situations where “due process” is of concern. Make sure that the responsible party (e.g., as declared on the package label) is notified of violations and receives copies of inspection reports. Establish standard operating procedures to assure the affected party of timely access to a representative of the weights and measures program so that the firm can provide the relevant information or obtain clarification of legal requirements.
2. Make the process as simple and convenient as possible. Especially in distant or rural areas where there are no local offices, the review should be conducted by a supervisor of the official taking the action if agreed to by the person filing the request for review.
3. The process should include notice that the firm can seek review at a higher level in the weights and measures program or an independent review by a third party. The following procedures are recommended:
 - (a) Any owner, distributor, packager, or retailer of a device ordered out of service, or item or commodity ordered “off-sale,” or inspection finding (e.g., a price misrepresentation or a shortweight lot of packages) shall be entitled to a timely review of such order, to a prompt, impartial, administrative review of such off-sale order or finding.

A notice of the right to administrative review should be included on all orders or reports of findings or violations and should be communicated to the responsible firm (e.g., person or firm identified on the product label):

Sample Notice

You have the right to Administrative Review of this order or finding. To obtain a review, contact the Director of Weights and Measures by telephone or send a written request (either postmarked, faxed, or hand delivered) to:

(Name, Address or Fax Number of the Director or other Designated Official)

Your request should reference any information that you believe supports the withdrawal or modification of the order or finding.

- (b) The administrative review shall be conducted by an independent party designated by the Director or before an independent hearing officer appointed by the Department. The officer shall not be a person responsible for weights and measures administration or enforcement.
- (c) No fees should be imposed for the administrative review process.
- (d) The firm responsible for the product or the retailer may introduce any record or other relevant evidence.

For example:

- i. Commodities subject to the off-sale action or other findings were produced, processed, packaged, priced, or labeled in accordance with applicable laws, regulations or requirements.
 - ii. Devices subject to the “stop-use” order or “condemnation” were maintained in accordance with applicable laws, regulations or requirements.
 - iii. Prescribed test procedures or sampling plans were not followed by the inspector.
 - iv. Mitigating circumstances existed which should be considered.
- (e) The reviewer must consider the inspector’s report, findings, and actions as well as any evidence introduced by the owner, distributor, packager, or retailer as part of the review process.
 - (f) The reviewer must provide a timely written recommendation following review unless additional time is agreed to by the department and the petitioner.
 - (g) The reviewer may recommend to the Department that an order be upheld, withdrawn or modified. If justified the reviewer may recommend other action including a reinspection of the device or commodity based upon information presented during the review.
 - (h) All actions should be documented and all parties advised in writing of the results of the review. The report of action should be detailed in that it provides the reasons for the decision.

2.6.11. Good Quantity Control Practices.

Good Quantity Control Practices means that the plant managers should take all reasonable precautions to ensure the following quantity control standards or their equivalent are met:

1. A formal quantity control function is in place with authority to review production processes and records, investigate possible errors, and approve, control, or reject lots.
2. Adequate facilities (e.g., equipment, standards and work areas) for conducting quantity control functions are provided and maintained.
3. A quantity control program (e.g., a system of statistical process control) is in place and maintained.
4. Sampling is conducted at a frequency appropriate to the product process to ensure that the data obtained is representative of the production lot.
5. Production records are maintained to provide a history of the filling and net content labeling of the product.
6. Each "production lot" contains on the average the labeled quantity and the number of packages exceeding the specified maximum allowable variation (MAV) value in the inspection sample shall be no more than permitted in Tables 2-1, **Class of Scale and 2-2. Acceptance Tolerances for Class of Scale Based on Test Load Divisions** in NIST Handbook 133.
7. Packaging practices are appropriate for specific products and measurement procedures (e.g., quantity sampling, density and tare determinations) and guidelines for recording and maintaining test results are documented.
8. Personnel responsible for quantity control follow written work instructions and are competent to perform their duties (e.g., background, education, experience and training). Training is conducted at sufficient intervals to ensure good practices.
9. Recognized procedures are used for the selection, maintenance, adjustment, and testing of filling equipment to insure proper fill control.
10. Weighing and measuring devices are suitable for their intended purpose, and measurement standards are suitable and traceable to national standards. This includes a system of equipment maintenance and calibration to include recordkeeping procedures.
11. Controls over automated data systems and software used in quantity control ensure that information is accessible, but changeable only by authorized personnel.
12. Tare materials are monitored for variation. Label changes are controlled to ensure net quantity matches labeled declaration.

2.6.12. Point-of-Pack Inspection Guidelines.

A. Weights and Measures Officials' Responsibilities.

1. Conduct inspections during hours when the plant is normally open for business. Open the inspection by making contact with the plant manager or authorized representative (e.g., the quality assurance manager or the production manager).
2. Present the proper credentials and explain the reason for the visit (e.g., routine or follow-up inspection or consumer complaint).
3. Request access to quantity measurement equipment in the packing room, moisture testing equipment in the laboratory or in the packing room, and product packed on premise or stored in warehouse areas.
4. Obtain permission from a plant representative prior to using a tape recorder or a camera.

5. Conduct inspection related activities in a professional and appropriate manner and, if possible, work in an area that will not interfere with normal activities of the establishment.
6. Abide by all the safety and sanitary requirements of the establishment and clean the work area upon completion of the inspection/test. Return borrowed equipment and materials.
7. To close the inspection, recheck inspection reports in detail and ascertain that all information is complete and correct.
8. Sample questions and tasks for Inspectors:

(a) Inside Buildings and Equipment.

- i. Is all filling and associated equipment in good repair?
- ii. Are net content measurement devices suitable for the purpose being used?
- iii. Are standards used by the firm to verify device accuracy traceable to NIST?

(b) Packing Room Inspection.

- i. Observe if the program for net quantity of content control in the packing room is actually being carried out.
- ii. Ensure that the weighing systems are suitable and tare determination procedures are adequate. If there are questions regarding tare determination, weigh a representative number of tare and/or filled packages.
- iii. For products labeled and filled by volume and then checked by weight, ensure that proper density is used.

(c) Warehouse Inspection.

If an inspection is conducted:

- i. Select lot(s) to be evaluated.
- ii. Determine the number of samples to be inspected. Use the appropriate sampling plan as described in NIST Handbook 133, "Checking the Net Content of Packaged Goods."
- iii. Randomly select the number of samples or use a mutually agreed on plan for selecting the samples.
- iv. Determine the average net quantity of the sample and use the standard deviation factor to compute the Sample Error Limit (SEL) to evaluate the lot.
- v. Look for individual values that exceed the applicable Maximum Allowable Variation as found in NIST Handbook 133.
- vi. Apply moisture allowances, if applicable.
- vii. Review the general condition of the warehouse relevant to package integrity, good quantity control, and distribution practices.
- viii. Prepare an inspection report to detail findings and actions.

9. Close the inspection - Review findings with Plant Representative.

After the inspection, meet with the management representative to discuss inspection findings and observations. Provide additional information as needed (e.g., information on laws and regulations or explanations of test procedures used in the inspection). Be informative, courteous and responsive. If problems/violations are found during the inspection/test, bring them to the attention of the appropriate person.

B. Plant Management Responsibilities.

1. Recognize that inspectors are enforcing a federal, state or local law.
2. Assist the official in conducting inspection activities in a timely and efficient manner.
3. During the initial conference with the inspector, find out whether the inspection is routine, a follow-up, or the result of a consumer complaint. If a complaint, obtain as much information as possible concerning the nature of the complaint, allowing for an appropriate response.
4. The plant manager, quality assurance manager, or any designated representative should accompany the inspector.
5. Plant personnel should take note of the inspector's comments during the inspection and prepare a detailed write-up as soon as the inspection is completed.
6. When an official presents an inspection report, discuss the observations and, if possible, provide explanations for any changes deemed necessary as a result of the inspection/test.

Plant Management: information that must be shared with the inspector.

1. Establishment name and address.
2. Type of firm and information on related firms or applicable information (e.g., sub-contractor, servant, or agent).
3. General description and location of shipping and storage areas where packaged goods intended for distribution are stored.
4. Commodities manufactured by or stored at the facility.
5. Names of responsible plant officials.

Plant Management: information that may be shared with the inspector.

1. Simple flow sheet of the filling process with appropriate net content control checkpoints.
2. Weighing or measuring device maintenance and calibration test records.
3. Type of quantity control tests and methods used.
4. Net content control charts for any lot, shipment, or delivery in question or lots which have previously been cited.
5. Method of date coding the product to include code interpretation.
6. Laboratory reports showing the moisture analysis of the products which are in question or have been previously cited.

7. Product volume of lot sizes or related information.
8. Distribution records related to a problem lots including names of customers.

2.6.13. Guideline for Verifying the Labeled Basis Weight of Communication and Other Paper.
(L&R, 1998, p. 27)

2.6.13.1. Equipment. – Linear measure recommended in Section 5.3.1. Equipment in the third edition of NIST Handbook 133 “Checking the Net Contents of Packaged Goods.”

- Scale with a minimum division of 0.5 g (0.001 lb) or less.
- Scientific calculator with a sample standard deviation function.

2.6.13.2. Scope and Recommended Enforcement Approach. – Paper is manufactured in various “basis weights” for use in different applications (e.g., copy paper can have a basis weight of 18 or 20 lb). Basis weight is part of the product identity and not a declaration of net contents. This procedure is used to audit the basis weight declared on package labels. If the tested packages in a sample do not have an average basis weight equal to or greater than the labeled basis weight, the inspection lot may be in violation. A potentially violative lot should be placed “off-sale” until the owner provides documentation to confirm that the labeled basis weight corresponds to the basis weight declared by the original manufacturer. If documentation is not provided, the inspection lot should remain “off-sale” until the basis weight declaration is corrected.

2.6.13.3. Determine Target Net Weight for Common Types of Paper. – The basis weight of paper is the designated weight (measured in grams or pounds per specified area) of one ream in basic sheet size for the type of paper being tested. This procedure permits the confirmation of basis weight by linear measurement and gravimetric testing. This procedure is designed to test the various types, size, count, and basis weights of packaged paper currently in the marketplace. Table 1 lists the “area of basic sheet size” for common types of paper. A “ream” equals 500 sheets of basic sheet size for all types of paper other than tissue paper. A “ream” of tissue paper equals 480 sheets. Each of the standard categories of paper products shown in Table 1 has a different standard basic sheet size. Although there are basic sheet sizes, paper is packaged and marketed in various sizes and counts. The net weight of packaged paper can be determined from the label information using the General Formula for Sheet Paper. For roll paper, use one (1) for the sheet count.

General Formula for Sheet Paper

$$\frac{PA \times BW}{BSS} \times \frac{SC}{500} \equiv TNW$$

Where:

- | | | |
|-----|---|---------------------------------------|
| PA | = | measured area of one sheet of paper |
| BW | = | labeled basis weight |
| BSS | = | area of basic sheet size from Table 1 |
| SC | = | labeled package sheet count |
| TNW | = | target net weight of paper |

2.6.13.4. Test Procedure. – The following gravimetric, measuring, and counting procedures shall be used to determine if packages are accurately labeled. Procedures are also provided for verifying net quantity of content declarations for count and dimensions (e.g., length and width.)

2.6.13.4.1. Sample Selection. – Select a sample from an inspection lot using Table 2-1 Sampling Plans of Category A (page A-2) in the fourth edition of NIST Handbook 133, “Checking the Net Contents of Packaged Goods.” Determine an average tare weight in accordance with Section 2 of the fourth edition of NIST Handbook 133.

2.6.13.4.2. Determine Target Net Weight of Common Types of Paper Packaged in Various Sizes or Counts.

Verify the basis weight declared on a package using the following gravimetric procedure:

- a. Record the following information from the package label on a worksheet. (See Figure 1 for a sample label.)
 1. Type of Paper (TP)
 2. Length (L)
 3. Width (W)
 4. Package Sheet Count (PSC)
 5. Basis Weight (BW)
 6. Basic Size Sheet (BSS)
- b. Compute the Target Net Weight (TNW) for the sample packages using the General Formula for Sheet Paper. TNW is what the paper should weigh if the labeled properties of the packaged paper are accurate.)
- c. Determine the average net weight of the sample packages. (Do not use sample error limit calculations.) If the average net weight is not equal to or more than the Target Net Weight, go to Section 2.6.14.3. to determine if the labeled basis weight (BW) is correct. If the average net weight is equal to or more than the labeled basis weight, the sample passes.

Basis Weight Worksheet (see Figure 1)

| | |
|--|----------------------|
| Type of Paper (TP): | Copy Paper |
| Length (L): | 11 in |
| Width (W): | 8½ in |
| Area (PA) of Sheet (L×W): | 93.5 in ² |
| Package Sheet Count (PSC): | 500 |
| Basis Weight (BW): | 20 lb |
| Basic Sheet Size (BSS): | 17 in × 22 in |
| Area of BSS from Table 1 or by calculation: | 374 in ² |

Use the General Formula to compute Target Net Weight (TNW):

Target Net Weight (TNW) = 5 lb

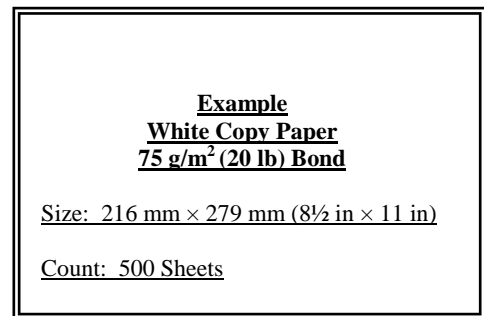

Figure 1. Sample Label

NOTE: Three factors will cause actual sample weights to differ from the TNW:

| | |
|---|---|
| Actual sheet count in package | |
| Actual basis weight of paper being tested | $\frac{(93.5 \text{ in}^2 \times 20 \text{ lb})}{374 \text{ in}^2} \times \frac{500}{500} = 5 \text{ lb}$ |
| Actual dimensions of the paper being tested | |

2.6.13.4.3. Determine Basis Weight.

This procedure is used to identify potentially violative packages. If the Average Basis Weight (ABW) for the sample determined by this procedure is not equal to or greater than the labeled basis weight, other steps must be taken. Moisture affects the weight of paper, but the moisture content of paper can only be determined in a measurement laboratory according to the Technical Association of the Pulp and Paper Industry (TAPPI) (URL: www.tappi.org/) TAPPI – T410 om-08, “Grammage of Paper and Paperboard (Weight per Unit Area).”

- a. Verify the basis weight for each package according to the following steps:
- i. Identify the paper type from Column 1 in Table 1 and record the area for the paper type from Column 2.
 - ii. Select a sample of paper from each of the tare sample packages. Use a sample of exact count to eliminate the possibility that the packages are short count.
 - For packages with more than 100 sheets, use 100 sheets; or
 - For packages with 100 sheets or less, verify the sheet count and use all of the sheets.
 - iii. Use a basis weight work sheet and determine the number of basic size sheets the paper sample represents with the following formula:

$$\frac{PA}{A} \times EC = ENBSS$$

Where:

A = area of basic sheet size from Table 1
 PA = area (l x w) of one sheet of paper
 EC = exact sheet count of sample
 ENBSS = equivalent number of basic size sheets

- iv. Determine the average basis weight,

Where:

BW = basis weight for each package
 ABW = average basis weight
 ENBSS = equivalent number of basic size sheets from step iii
 NW = net weight of sample
 RC = Ream Count (500; for tissue paper, use 480)
- v. Repeat this step for each paper package from the tare sample and average the basis weights to obtain an Average Basis Weight (ABW). If the ABW is less than the labeled basis weight, or if the difference between the basis weight of the sample packages is more than 1 scale division, measure and compute the basis weight for each of the remaining packages.
- vi. Weigh each sample. If the basis weight from step iv is less than the labeled basis weight, recalculate the target net weight by using the general formula for sheet paper.

| Paper Type | Area |
|---|---|
| Bond, Ledger, Thin, Writing, and Track Feed Printer Paper | 2412 cm ² (374 in ²) |
| Manuscript Cover | 3599 cm ² (558 in ²) |
| Blotting | 2941 cm ² (456 in ²) |
| Cover | 3354 cm ² (520 in ²) |
| Blanks | 3974 cm ² (616 in ²) |
| Printing Bristols | 4135 cm ² (641 in ²) |
| Wrapping, Tissue, Waxed, Newsprint and Tag Stock | 5574 cm ² (864 in ²) |
| Book, Offset, and Text | 6129 cm ² (950 in ²) |
| Index Bristol | 5019 cm ² (778 in ²) |

- vii. Use the target net weight computed in step vi and re-weigh the inspection lot samples using the Section 2. of the fourth edition of NIST Handbook 133. If inspection sample weights differ from the target net weight computed using the average basis weight determined in vi, the label sheet count is probably inaccurate.
- b. Verify the label sheet count by counting the number of sheets in each package.
- c. Verify sheet dimensions (length x width) for each package of the sample.

$$\frac{NW \times RC}{ENBSS} = BW$$

2.6.13.4.3.1. Other Types of Packaged Paper.

1. Roll Paper. – When testing rolled paper, cut a length of paper from the roll equal to 9350 divided by the width of the paper in inches. Make sure the ends of this length of paper are square. Proceed to section 2.6.14.3 step a. Disregard the exact sheet count in step iii.
2. Continuous Track Feed Printer Paper:
 - i. Count out a sample of 100 sheets from each tare sample package of the inspection lot.
 - ii. Weigh each 100 sheet sample and record the weights.
 - iii. Calculate an average weight.
 - iv. Remove printer track feed strips from each sample.
 - v. Re-weigh each sample after the tractor feed has been removed and record the weights.
 - vi. Calculate an average weight from step v.
 - vii. Calculate percentage (%) difference in the average weights in steps iii and vi.

- viii. After the track feed strips have been removed, use the samples to verify the basis weight for the packages of the inspection lot using the formula in 2.6.14.2. If the basis weight is less than the labeled basis weight, refer to 2.6.13.2.
- ix. If the basis weight established in step viii is the same as the labeled basis weight, weigh the remaining packages from the sample and compare the actual net weights with the TNW. (Remember to adjust the TNW up by the percentage established in step vii.)
- x. If the adjusted weights of the remaining samples is less than the TNW, the deficiency may have been caused by:
 - a. the sheet count in the package.
 - b. the basis weight of the paper.
 - c. the dimensions of the paper.
 - d. combinations of the above.

This procedure is for use in verifying that the basis weight included in a statement of identity is not misleading or deceptive. It is not intended to be used as the final criterion on which enforcement action is taken. Instead, the test procedure is only used to identify potentially ~~violative~~**volatile** lots. There are two alternative actions that can be taken if the test results indicate that a lot is potentially ~~violative~~**volatile**. The first is to review the documentation supplied by the original manufacturer to the converter to determine if any misrepresentation has occurred. The second is to collect packages of the paper and test them according to the latest version of ASTM International Method D646 for “Grammage of Paper and Paperboard.”

2.6.14. Labeling Guidelines for Chamois.

(L&R, 1999, p. L&R-25)

These requirements are based on the Uniform Packaging and Labeling Regulation in the 1999 edition of NIST Handbook 130, “Uniform Laws and Regulations” and regulations and guidelines of the Federal Trade Commission.

General

The following information must be declared on the principal display panel of the chamois package. The principal display panel is the tag, or label that consumers can examine under normal and customary conditions of display.

- Identity - what the package contains
- Net Quantity of Contents - how many items the package contains and the area of the item(s)

The following information may appear anywhere on the package.

- Responsibility – the party responsible for packaging or distributing the product.

2.6.14.1. Declaration of Identity. – Chamois is a natural product made of sheepskin which has been oil tanned. In 1964, the FTC issued an advisory opinion stating that using the word “chamois” on a product (e.g., “Artificial” Chamois, “Synthetic” Chamois, “Pig Chamois” or “Man Made” Chamois) that is not made from oil tanned sheepskin is unlawful and deceptive. Packages are required to declare identity in terms of:

- i. the name specified in or required by any applicable federal or state law or regulation or, in the absence of this,

- ii. the common or usual name or, in the absence of this,
- iii. the generic name or other appropriate description, including a statement of function.

Example:

Chamois, Natural Chamois Leather

2.6.14.2. Declaration of Net Quantity of Contents. – The following information is required to appear on the lower 30 % of the principal display panel of all packages:

Count

- The package must include a count declaration (e.g., 1 Chamois) unless the statement of identity clearly expresses the fact that only one unit is contained in the package. A package containing two or more units shall bear a statement in terms of count (e.g., 2 Chamois).

Area

- Chamois packages must have area declarations in both inch-pound and metric units.

Metric

- For areas that measure less than 1 m², the area shall be stated in square decimeters and decimal fractions of a square decimeter or in square centimeters and decimal fractions of a square centimeter;
- For areas that measure 1 m² or more, the area shall be stated in square meters and decimal fractions to not more than three places.

To facilitate value comparison and simplify the measurement process, chamois should be measured in one quarter square foot (2.322 57 decimeter) increments. Dimensions should be rounded down to avoid overstating the area.

For example: 2 square feet (18.5 square decimeters) or 2 ft² (18.5 dm²)

Conversion Factors:

$$1 \text{ ft}^2 = 9.290 \text{ 30 dm}^2$$

$$1 \text{ in}^2 = 6.451 \text{ 6 cm}^2$$

$$1 \text{ yd}^2 = 83.612 \text{ 7 dm}^2$$

Inch-pound Units

- For areas that are less than 1 ft² (929 cm²), the area declaration shall be expressed in square inches and fractions of square inches;
- For areas of 1 ft² (929 cm²), or more, but less than 4 ft² (37.1 dm²), the area shall be expressed in square feet with any remainder expressed in square inches or in fractions of a square foot;
- For areas of 4 ft² (37.1 dm²) or more, the area should be expressed in terms of the largest whole unit (e.g., square yards, square yards and square feet, or square feet) with any remainder expressed in square inches and fractions of a square inch or in fractions of the square foot or square yard.

Chamois labeled for retail sale is exempt from these requirements if (a) the area of a full skin is expressed in terms of square feet with any remainder in terms of the common or decimal fraction of the square foot

(929 cm²), or (b) the area for cut skins of any configuration is expressed in terms of square inches and fractions thereof. Where the area of a cut skin is at least one square foot (929 cm²) or more, the statement of square inches shall be followed in parentheses by a declaration in square feet with any remainder in terms of square inches or common or decimal fractions of the square foot.

Prohibited Labeling Practices

- Do not use qualifying terms or phrases (e.g., “Approximate Size,” “Size when Wet,” “Up to 20 % Larger When Wet”).
- Do not use unacceptable symbols (e.g., using (") as a symbol for inches is not acceptable).

2.6.14.3. Declaration of Responsibility. – The name and address of the manufacturer, packer, or distributor must be conspicuously specified on the label of any package that is kept, offered, exposed for sale, or sold anywhere other than the premises where packed. The name shall be the actual corporate name, or, when not incorporated, the name under which the company does business. This declaration does not have to appear on the principal display panel.

For example:

Chamois Tanning Company
8190 Main Road
Tarpon Springs, FL 34568

The address shall include street address, city, state (or country if outside the United States), and ZIP Code (or the postal code, if any, used in countries other than the United States); however, the street address may be omitted if it is shown in a current city directory or telephone directory.

Sample Labels

1. If one natural chamois is in a see through package, the following label would be acceptable:

| |
|---|
| <p>Natural Chamois Leather</p> <p>Distributed by: Chamois Leather Co. 8190 Main Road Tarpon Springs, FL 34568</p> <p>7 ft² (65 dm²)</p> |
|---|

2. The next sample would apply if one chamois is in a package and the statement of identity does not clearly express the fact the package only contains one unit.

| |
|--|
| <p>Chamois</p> <p>Chamois Leather Company 8190 Main Road Tarpon Springs, FL 34568</p> <p>One Chamois</p> <p>3 ft² (27.8 dm²)</p> |
|--|

2.6.15. Labeling Guidelines for Natural and Synthetic Sponges.

(L&R, 1999, p. L&R-31)

These requirements are based on the Uniform Packaging and Labeling Regulation in NIST Handbook 130, “Uniform Laws and Regulations” and regulations and guidelines of the Federal Trade Commission. All indicated dimensions and conversions from metric to inch-pound units are approximate only and are used for illustration purposes only.

General

The following information must be declared on the principal display panel (PDP) of a package of sponge(s). The PDP is the part of label (or package) most likely to be displayed, presented, shown to or examined by consumers. A tag or spot label may be used.

- Identity – what the package contains
- Net Quantity of Contents – how many items in the package and the dimensions of the item(s)

The following information may appear anywhere on the package.

- Responsibility – the name of the processor or distributor

2.6.15.1. Declaration of Identity.

- a. A declaration of identity that clearly describes the origin and other relevant information about the sponge must appear on the label of each package. The identity of a sponge must include information about its origin (i.e., is it a natural or synthetic sponge). The identity shall be in terms of (i) the name specified in or required by applicable federal or state law or regulation, or (ii) the common or usual name, or (iii) the generic name or other appropriate description.

For example:

Sea Wool Sponge, Rock Island Sponge, Sea Grass Sponge, Sea Yellow Sponge, or Atlantic Silk Sponge

- Origin - Natural or Synthetic
- For natural sponges, the label must specify if they are “Cut” or “Form.” “Cut” sponges are those that have been cut into halves, quarters, or fourths while “forms” are whole sponges.
- For natural sponges, indicate type of sponge (e.g., “silk,” “seawool,” or “yellow”)

b. Identifiers

- Terms which indicate locations of origin on some natural sponges (e.g., “Atlantic Sea Sponge”) are permitted to be used for identification if they accurately describe the source of the sponge.
- Use of terms that may be interpreted by consumers to imply quality, durability, or “expert” endorsement (e.g., “professional quality sponge”) are permitted as identifiers if they are not misleading. However, terms that imply quality should be used with care if they are not based on a recognized grading system. Use of terms to describe sponge texture such as “fine,” “medium,” or “coarse” are acceptable.

2.6.15.2. Declaration of Net Quantity of Contents. – The following information must appear on the lower 30 % of the principal display panel of all packages:

- Count

The package must include a count declaration (e.g., 1 sponge) unless the statement of identity clearly expresses the fact that only one unit is contained in the package. A package containing two or more units shall bear a statement in terms of count (e.g., 2 sponges).

- Dimensions

The package must include the dimensions of the sponges in inches and centimeters.



Silk Sponges

To facilitate value comparison and simplify the measurement process, sponges should be measured in ½ in (1 cm) increments. Dimensions should be rounded down to avoid overstating the size of a sponge.

For example:

- 6 in, 6½ in, and 7 in for inch declarations;
- 15 cm, 16 cm, and 17 cm for metric declarations

- Synthetic sponges: the dimensions shall include length x width x height (thickness). Either unit of measure can be the primary declaration (e.g., the metric or inch-pound units can be presented first).

1 Sponge 17 x 10 x 5 cm (7 x 4 x 2 in)

- Natural sponges: the declaration shall be a single measurement representing the maximum dimension of one axis of a sponge that is passed through a circular template. When measured, the sponge is “classified” as a specific size when at least three (including two opposing) points of the sponge touch the template (e.g., see graphic on the following page where the sample sponge is designated as a 7 in [17 cm] sponge).

As the following pictures show, natural sponges are irregular in size and shape and have traditionally been measured using this procedure. It is difficult to develop a meaningful or cost effective measurement process that would provide a means of direct comparison between synthetic and natural sponges based on dimensions. Requiring declarations, such as average height, length, or width of natural sponge procedures would increase the costs for industry and consumers.



Sea Wool Sponges



Sea Grass Sponges

This graphic illustrates an irregular form of a natural sponge passing through a 17 cm (7 in) template and touching at least two opposite points. This sponge could be labeled 7 in.

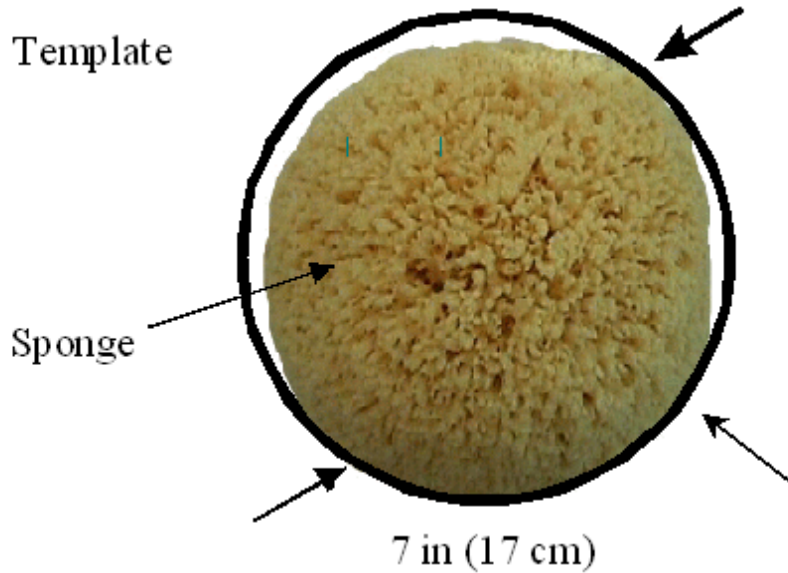

- For banana sponges the size will be determined as shown below. This sponge is 17 cm (7 in).

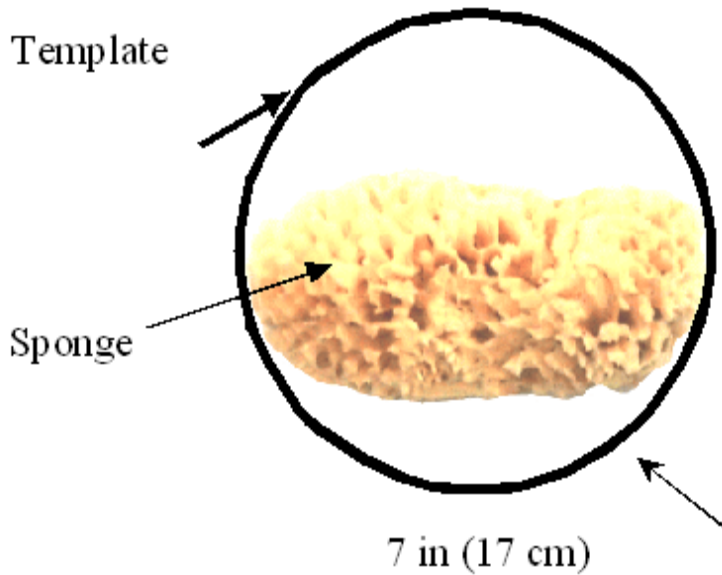

Good Measurement Practice

- Dimensions are determined with the sponge wet.
- Measuring templates (see photo below for the currently used type templates):

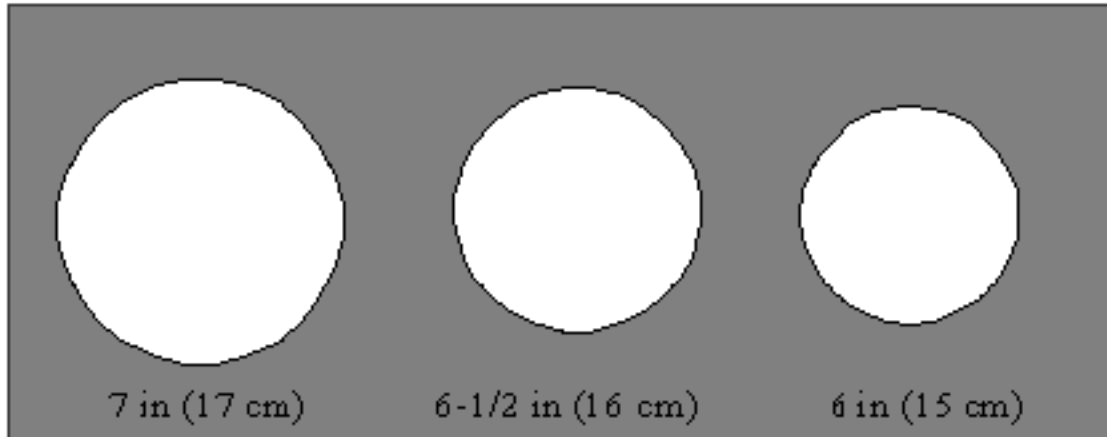

- should be constructed of rigid metal or plastic material.
- circular openings should graduate in increments of one-half inch (one centimeter).
- The error in the circular openings shall not be greater than $\pm \frac{1}{32}$ in (± 0.79 mm) as specified in Table 2. Tolerances in Section 5.52. Linear Measures of NIST Handbook 44 “Specifications, Tolerances, and Technical Requirements for Weighing and Measuring Devices.”



Prohibited Labeling Practices

- Stating country of origin declarations that are not accurate.
- Declaring ranges of dimensions (e.g., 4"- 5" in) or using terms such as “half or semi form” instead of either “cut” or “form.”
- Using qualifying terms. (e.g., “Wet Size,” “Approximate” or “Jumbo”)
- “Anti-bacterial” claims must meet EPA requirements.
- Using type size that does not meet minimum height requirements.
- Using unacceptable symbols (e.g., using (") as a symbol for inches is not acceptable).

2.6.15.3. Declaration of Responsibility. – The name and address of the processor or distributor must be specified on the label of any package that is kept, offered, or exposed for sale, or sold anywhere other than the premises where packed. The name shall be the actual corporate name or, when not incorporated, the name under which the business is conducted.

For example:

Processed by
 Argonaut Sponge Company
 8190 Main Road
 Tarpon Springs, Florida 34568

The address shall include street address, city, state (or country if outside the United States), and ZIP Code (or the postal code, if any, used in countries other than the United States); however, the street address may be omitted if this is shown in a current city directory or telephone directory.

Sample Labels

Yellow Sponge Cut
Argonaut Sponge Company
8190 Main Road
Tarpon Springs, FL 34568

One - 17.7 cm (7 in)

If a natural sponge is in a box, carton, or package that does not permit consumers to see how many sponges are in the box, the package must include a count declaration (e.g., 1 sponge) unless the statement of identity clearly expresses the fact that only one unit is contained in the package. A package containing two or more units shall bear a statement in terms of count (e.g., 2 sponges). The following sample label would apply.

Synthetic Sponge
Made by:
Argonaut Sponge Company
8190 Main Road
Tarpon Springs, FL 34568

17.7 x 10 x 5 cm (7 x 4 x 2 in)

Synthetic Sponge
Made by:
Argonaut Sponge Company
8190 Main Road
Tarpon Springs, FL 34568

1 - Sponge 17.7 cm x 10 x 5 cm (7 in x 4 in x 2 in)

If a package does not permit the consumer to see how many sponges are the box, it must include a count declaration (e.g., 1 sponge) unless the statement of identity clearly expresses the fact that only one unit is contained in the package. A package containing two or more units shall bear a statement in terms of count (e.g., 2 sponges). A transparent bag of small pieces of sponge may be sold on the basis of count if the words "Irregular Dimensions" appear in conjunction with the declaration of count (e.g., 10 Sponges - Irregular Dimensions).

2.6.16. Minimum Fuel Flush for Octane Verification.

(L&R, 2000, p. L&R-13)

A minimum of 1.2 L (0.3 gal) of motor fuel shall be flushed from a dispenser before taking a sample for octane verification. The flush shall be returned to the storage tank containing the lowest octane.

THIS PAGE INTENTIONALLY LEFT BLANK

MARKUP COPY